

Decorative tessera cotta panel (part of frieze).
No name. $6\frac{1}{2}'' \times 6\frac{1}{2}'' \times 2\frac{1}{8}''$ no panels
Sovereign Rd dem. Wigan 6. 7. 80

2009 x

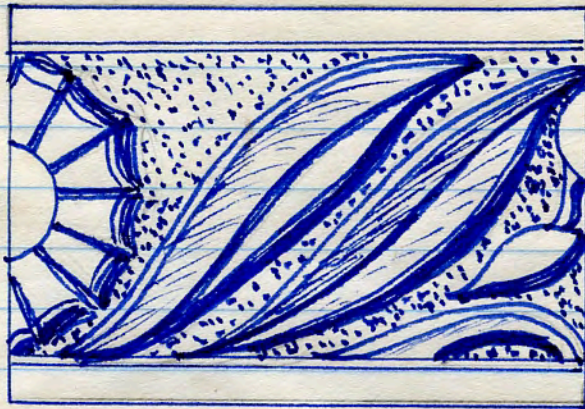

2010 xx

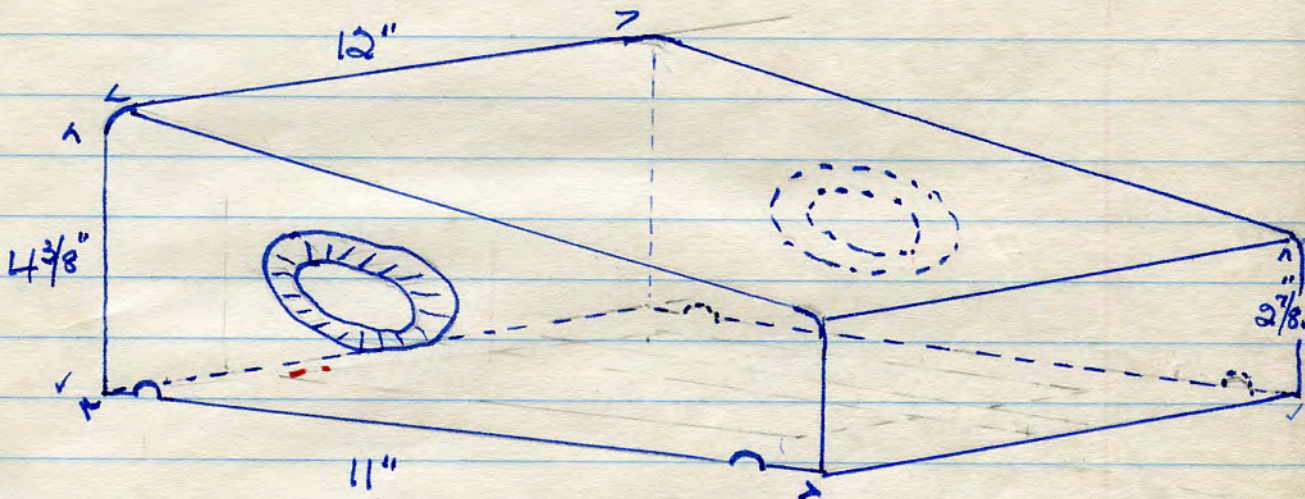

Tessera cotta wall capping piece from
Bispham Hall Bk Wks, Smithurst Rd. Orrell.
#26 lbs. yellow. 6. 7. 80.

2011 x

Tessera cotta floor tile, red. octagonal $6'' \times 6'' \times 1''$
No panel, no name. 2 lbs
Longport Industrial Site.
13. 7. 80.

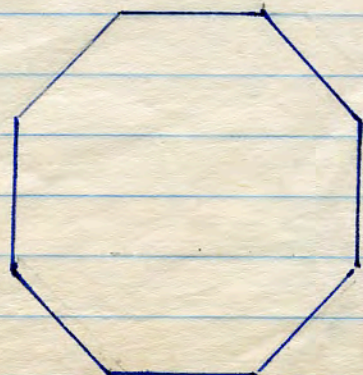

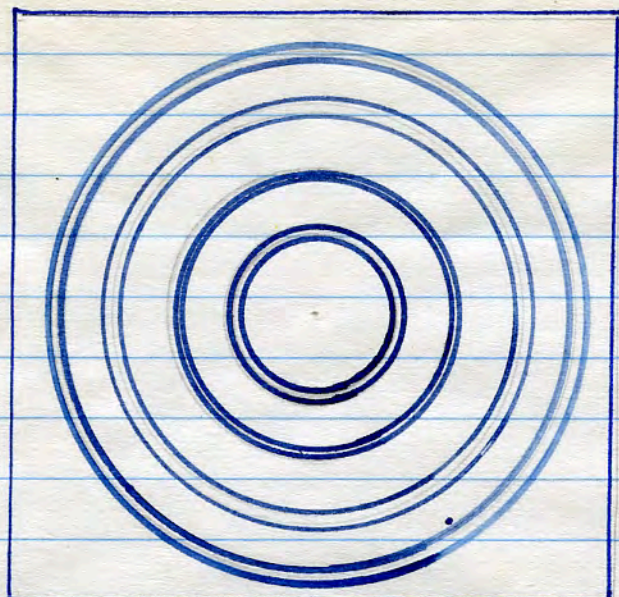

Blue floor tile
 plain obv. 0 panels rev.
 $5\frac{1}{8}'' \times 5\frac{1}{8}'' \times 1''$
 1 1/2 lbs
 Longport Industrial
 Site. 13. 7. 80.

2012 x

Garden edge tile, blue
 $9\frac{1}{2}'' \times 4'' \times \frac{3}{4}'' \times 2\frac{1}{4}''$
 2 dowel holes $\frac{5}{8}''$ in mould,
 cable pattern
 Longport Industrial Site
 13. 7. 80

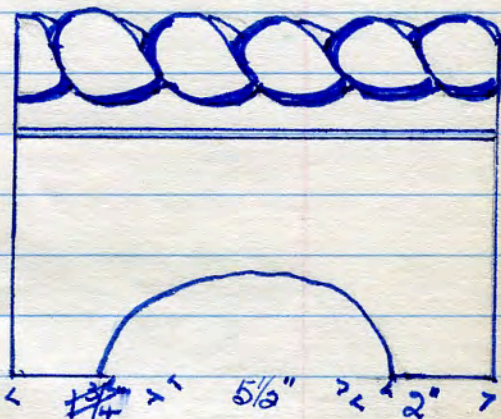

2013 x

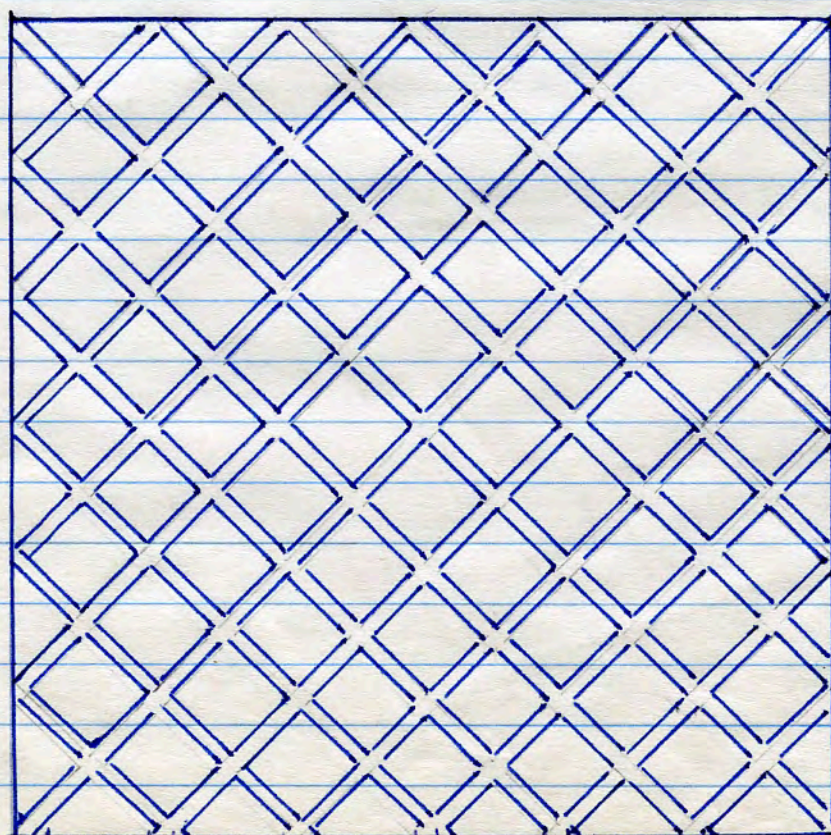

Floor tile in
 buff fire clay.
 no name.
 $8\frac{1}{2}'' \times 8\frac{1}{2}'' \times 1\frac{3}{8}''$
 plain reverse.
 7 lbs
 Sutton Rd opp
 Manor Arms.
 St Helens
 29. 6. 80.

2014 x

Ventilator (air brick). 9" x 6 1/4" x 2 7/8" 6 1/2 lbs.
Mensey St. Warrington 6. 7. 80 red.

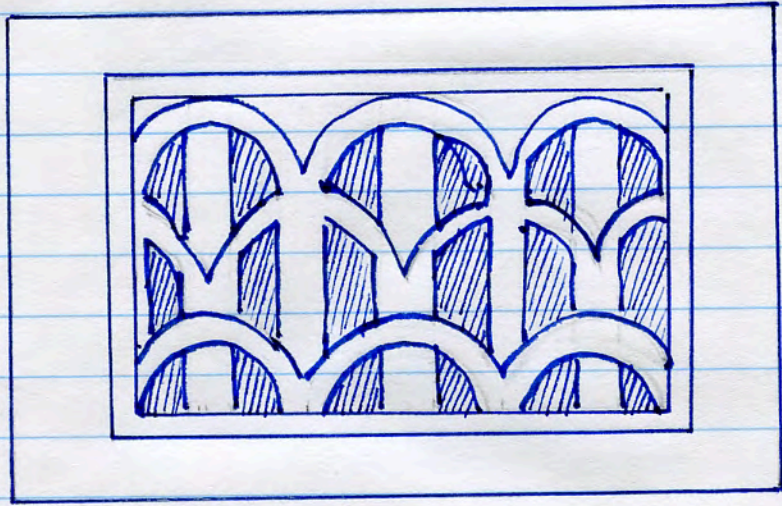

2015 x

FCO ΩΩΩ
red floor tile 6" x 6" x 7/8" 1 1/2 lbs.
plain obv. Sutton Rd, St Helens 29. 6. 80.



2016 x

No name. Blue wall capping.
7 lbs. 8 7/8" x 4 1/4" x 2 3/4"
2061 x Malam St. dem. 20. 7. 80. Hanley

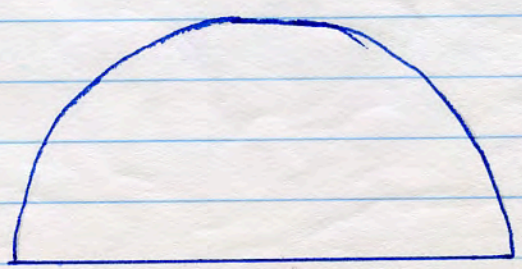

2062 rectangular shallow panel rev.
 No name. blue paver 7 lbs.
 18 buttons $9\frac{1}{8}'' \times 4\frac{1}{2}'' \times 2''$
 Longport Indus. Estate tip 13. 7. 80

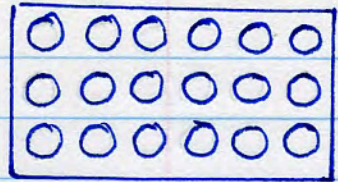

2063 No name, blue paver. 6 lbs.
 7 whole buttons 12 halves $8\frac{1}{2}'' \times 4\frac{1}{2}'' \times 2\frac{1}{4}''$
 mitred paver to form design.
 no panels.
 Malam St dem. Hanley. 20. 7. 80

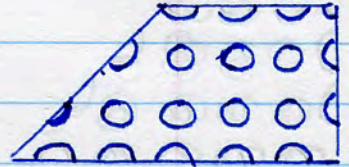

2064 No name, blue paver. 6 lbs.
 $9'' \times 4\frac{1}{2}'' \times 2\frac{1}{4}''$. no buttons.
 single panel rev. mitred
 Malam St. dem. Hanley. 20. 7. 80

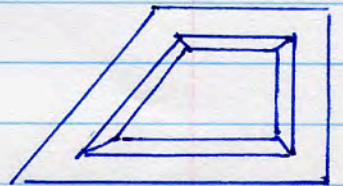

2065 BCM/HORSESHOE FCO MADE IN ENGLAND
 blue paver 7 lbs. $9'' \times 4\frac{1}{2}'' \times 1\frac{5}{8}''$
 single panel rev.
 letters in relief.
 Malam St. dem. Hanley. 20. 7. 80.

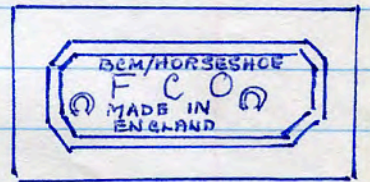

2066 CALLENDER ELECTRIC
 7 lbs. $9'' \times 4\frac{3}{8}'' \times 1\frac{3}{8}''$
 blue cable cover. letters incised
 small single panel obv.
 Malam St. dem. Hanley. 20. 7. 80.

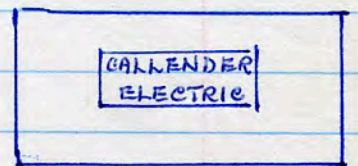

2067 R TILSLEY hand blue paver
 8 lbs. $9\frac{1}{8}'' \times 4\frac{3}{8}'' \times 2''$
 single panel obv only, plain rev.
 letters incised faint
 Malam St dem. Hanley. 20. 7. 80

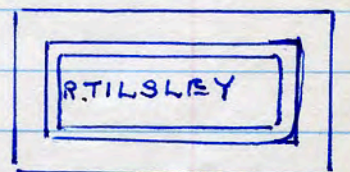

VITROS blue paper

7 lbs 9" x 4⁵/₁₆" x 1³/₄"

single panel obs. only. plain rev.

letters in relief

Longport Indus. Estate tip 13. 7. 80.

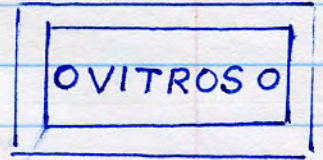

2068
x

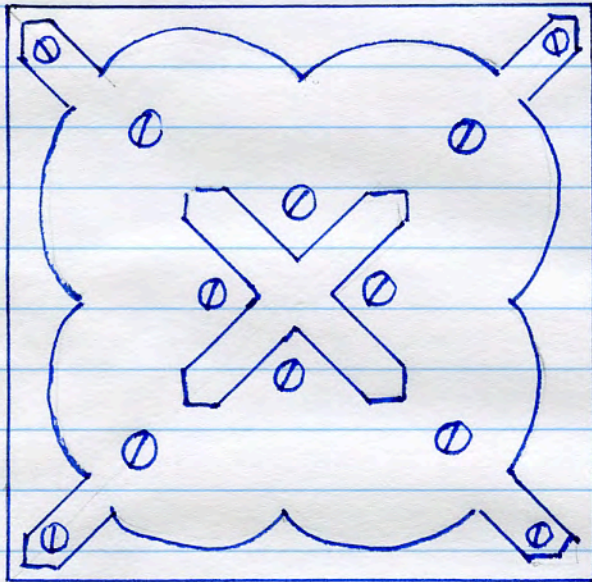

no name
red tile 6" x 6" x 7/8"
2 lbs 10 ozs
Longport Indus. Estate
tip 20. 7. 80.

2081
x

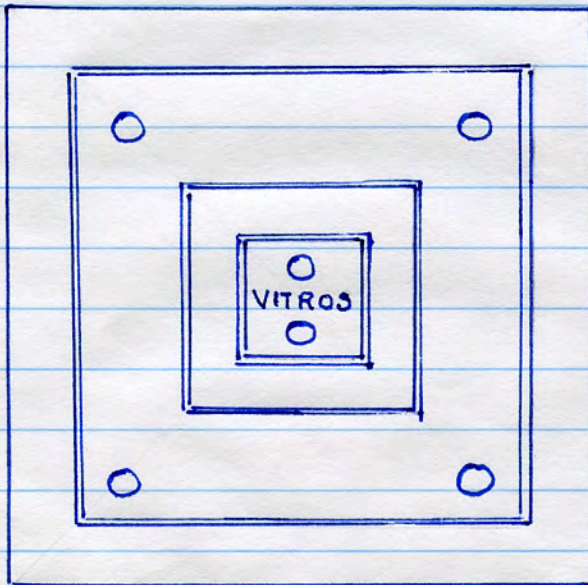

VITROS
red tile 6" x 6" x 5/8"
letters in relief 2 lbs.
Longport Indus. Estate
tip 20. 7. 80.

2082
x

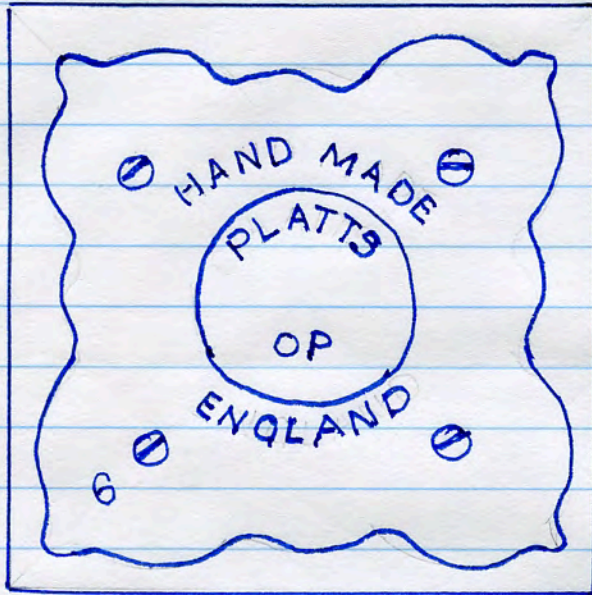

PLATTS HAND MADE
ENGLAND O.P.
letters in relief
2 1/2 lbs 6" x 6" x 7/8"
red tile
Longport Indus. Estate
tip 20. 7. 80

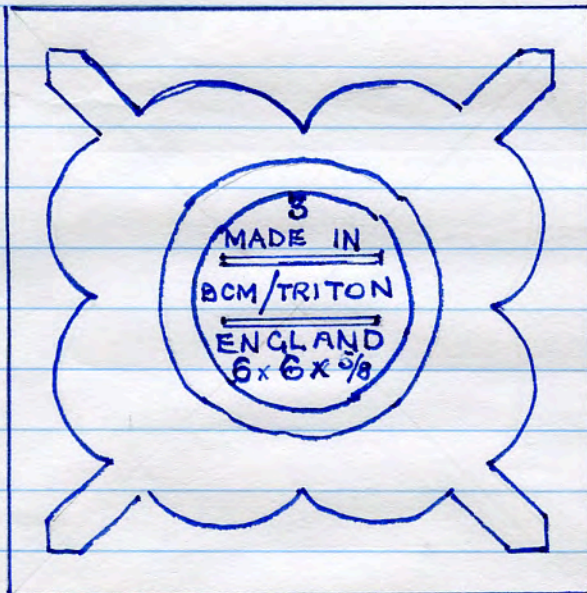

BCM/TRITON 3
MADE IN ENGLAND
6 x 6 x 5/8
letters in relief.
red tile 1 1/2 lbs
Longport Indus. Estate
tip 20. 7. 80

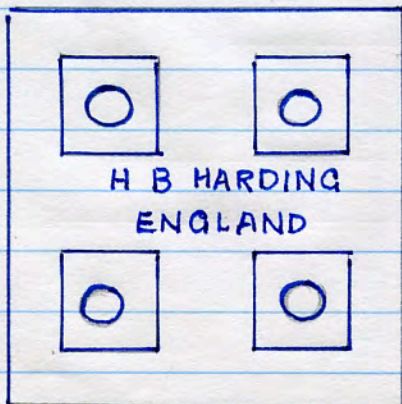

H B HARDING ENGLAND
yellow tile (modern)
8 o/s. 4" x 4" x 3/8"
letters in relief
Malam Street dem. Hanley
20. 7. 80.

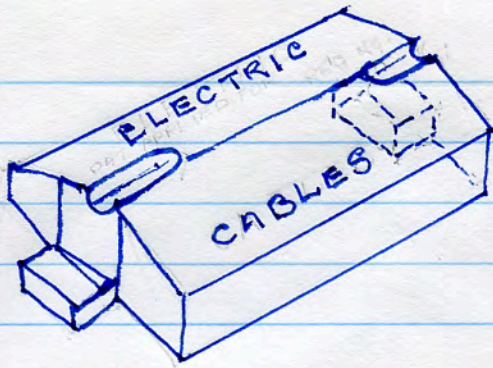

2086

ELECTRIC CABLES

PAT APPLIED FOR

REG NO

letters incised

9 1/2" x 4 1/8" x 2"

5 1/2 lbs

Thomas Street dem. Nelson 24. 7. 80.

No name, blue wall capping 3" thick.
10 lbs.

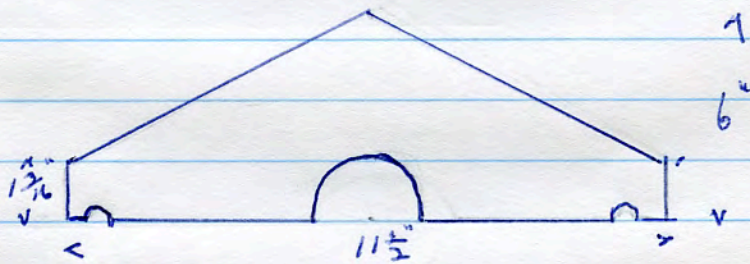

2104

cross lane, Westle 1/4. 3. 8. 80.

No name.

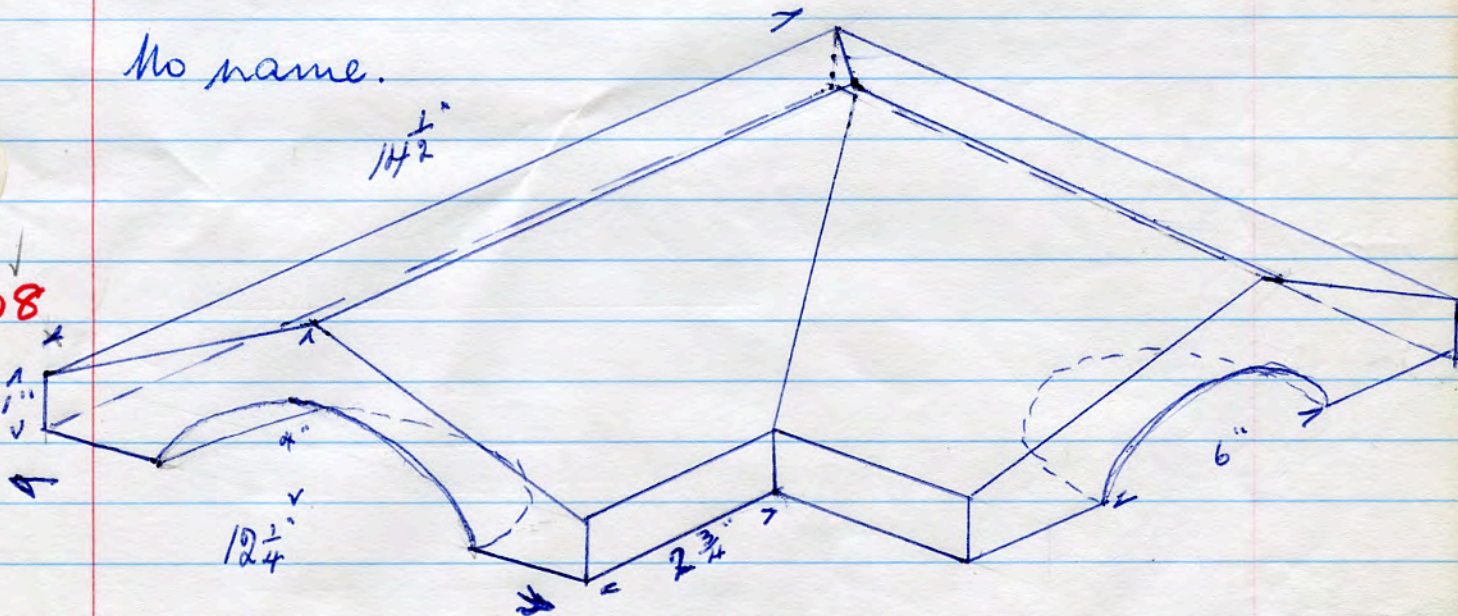

2108

38 lbs.

Blue wall capping return

Darley St. Farnworth 3. 8. 80.

No name. Gilded boss red
 14 lbs. $6\frac{3}{8}" \times 6\frac{3}{8}" \times 1\frac{1}{4}"$ base
 projection of decoration $2\frac{1}{2}"$
 Back Leopold St. Weaste .3. 8. 80.

2119
 x



EB - terra cotta, single course header with
 $6\frac{1}{2}$ lbs letters incised. mould

2127
 x

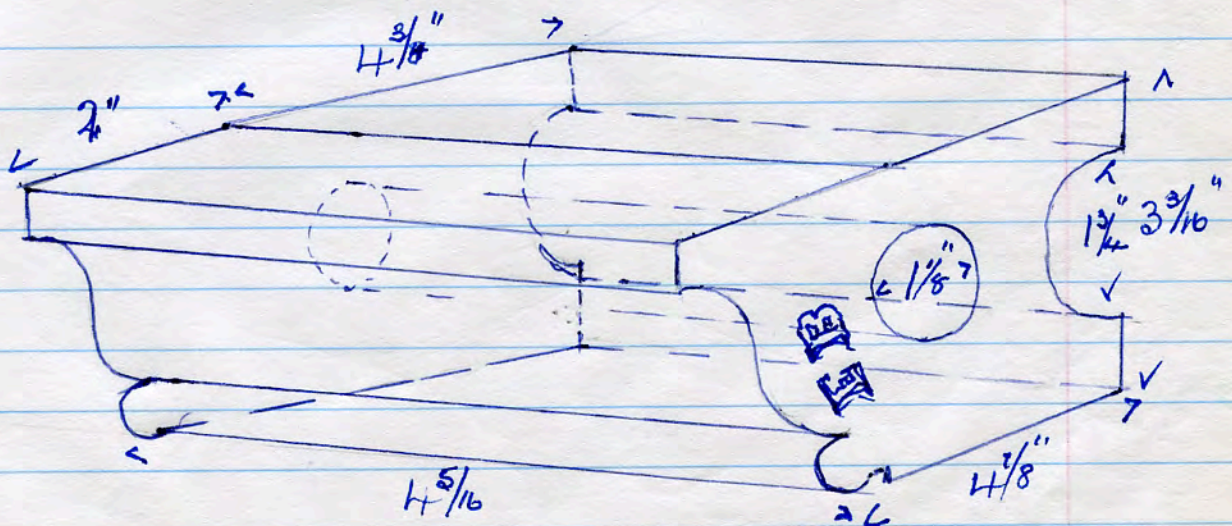

Burkin head (town centre dem) 10. 8. 80.

Y H 1

2166

gauged arch brick

7 lbs. $8\frac{1}{2}'' \times 4\frac{3}{8}'' \times 2\frac{3}{4}'' - 2''$

letters stamped on head end.

Richmond St. Ashton u Lyne 31. 8. 80.



2167

No name, part floor brick, cream.

 $4\frac{1}{2}'' \times 4\frac{3}{8}'' \times 2\frac{5}{16}''$ 5 lbs.

Newton Heath. 7. 9. 80.

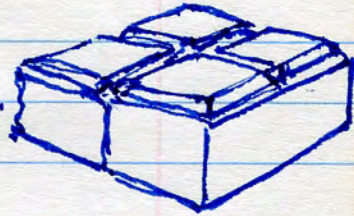

2168

No name, (presumed Monk & Newell, Rnabow).

Return stringcourse - red.

Panel on reverse.

11 lbs.

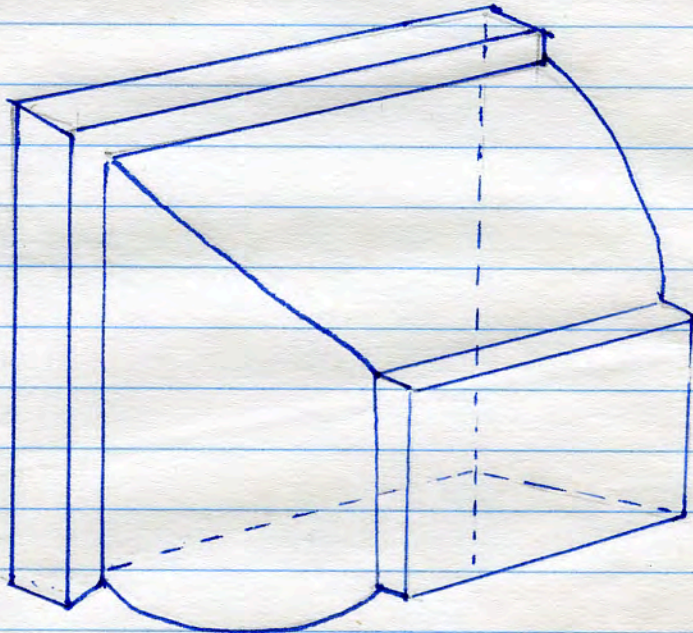
 $8\frac{7}{8}'' \times 5\frac{7}{8}'' \times 3\frac{1}{8}''$ 

Zennel St. dem. M/V Victoria 24/8/80.

9 lbs.

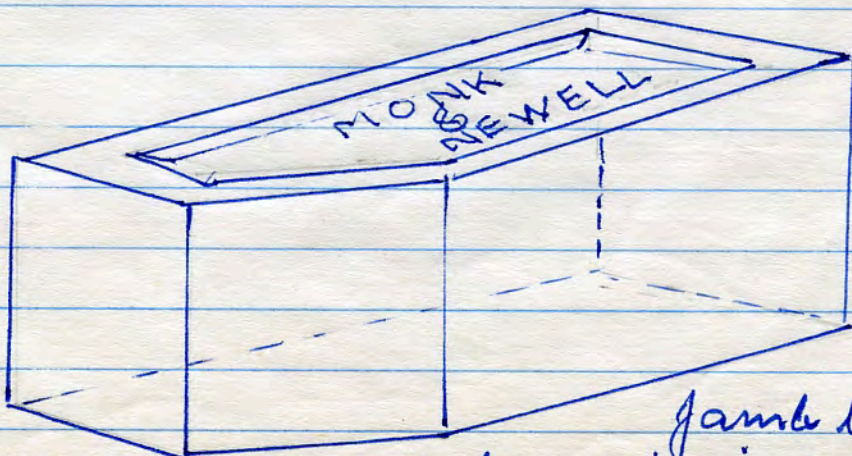

2169

single panel each side, letters incised.

Zennel St. dem. M/V Victoria 24. 8. 80.

jamb brick, red.

Stretchers moulding. No name.

✓
2170*
x

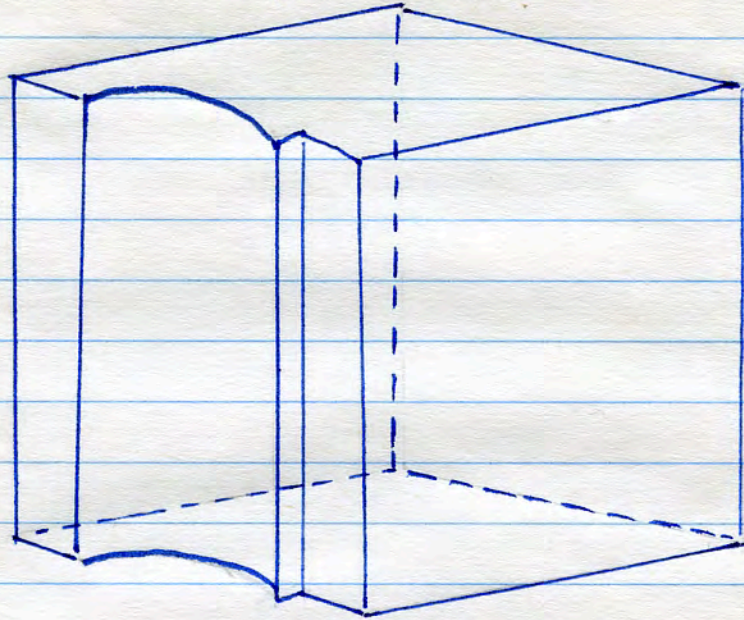

9 lbs. red.

8 7/8" x 4 3/8" x 3 1/8"

Pennant panel
new.

Jennel St dem
M/s Victoria

24. 8. 80.

Stretchers mould.

✓
2171*
x

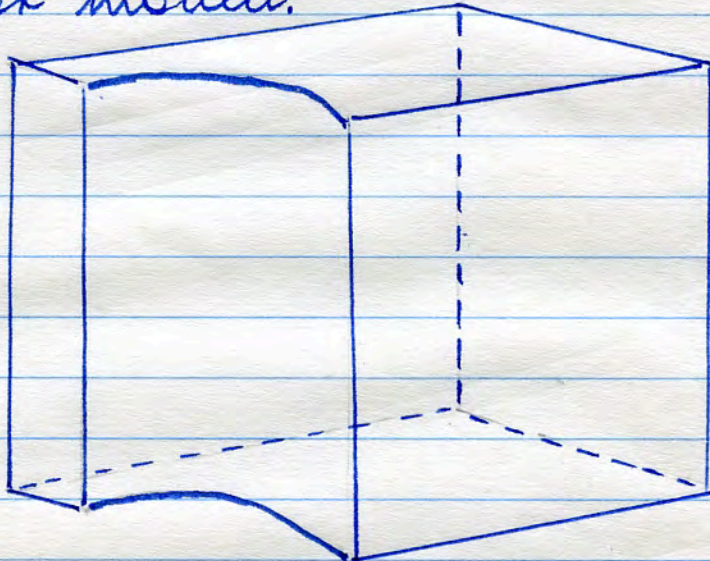

9 lbs. red.

9" x 4 1/2" x 3 3/16"

Single rect/g.
panel new.

Jennel St dem
M/s Victoria.

24. 8. 80.

✓
2172*
x

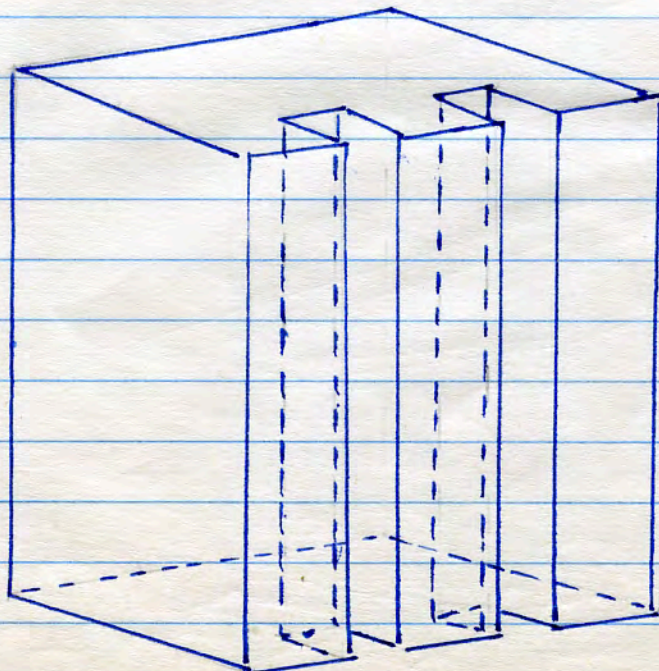

Decorative stretchers.

9 lbs. red

9" x 4 1/2" x 3 1/8.

Single rect/g. panel
each side.

Jennel St. dem
M/s. Victoria

24. 8. 80.

no name.

moulded stretchers.

12 lbs.

9" x 6" x 3 1/8"

single
rect/g
panel 1 side

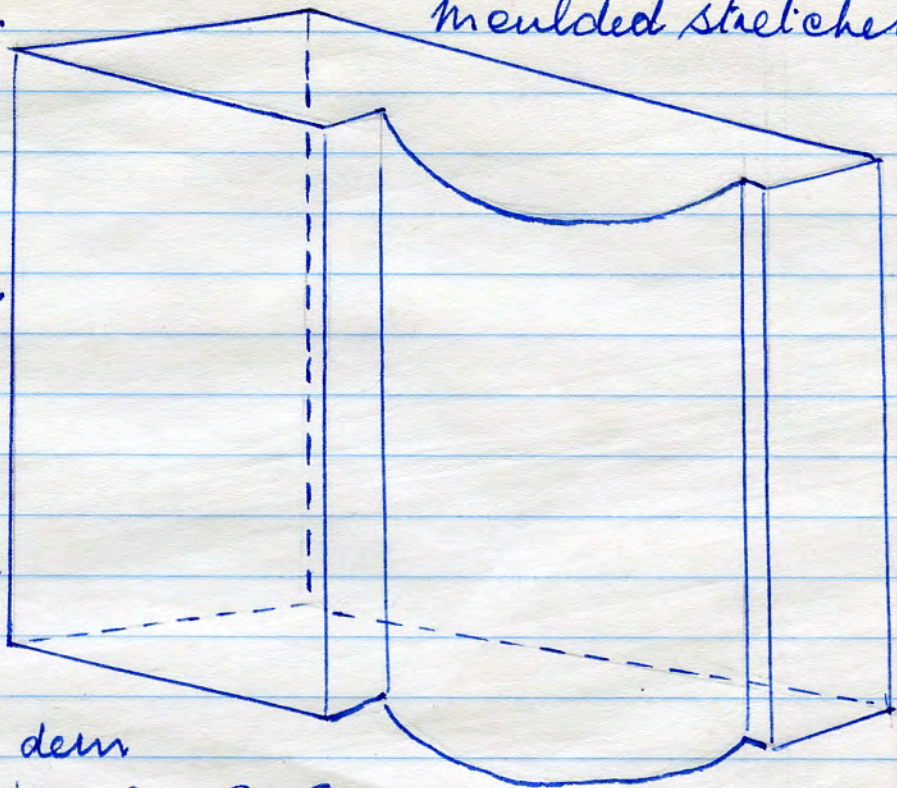

Kennel St dem
Mfr Victoria 24. 8. 80.

2173
x

moulded header.

no name

9 lbs

8 1/8" x 4 1/4" x 3 1/8"

single rec.
panel each
side.

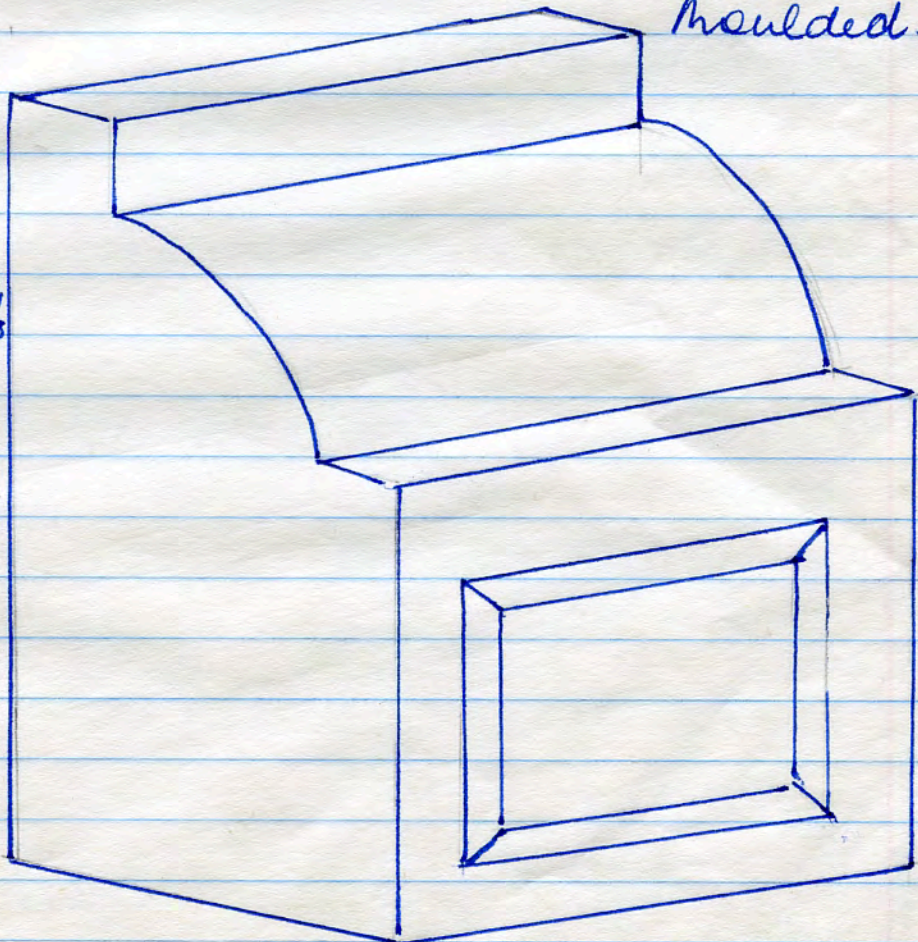

Kennel St dem. Mfr Victoria, 24. 8. 80

2174
x

No name. H24 red
Piano moulded stretcher.
14 lbs. $8\frac{1}{8}'' \times 6'' \times 3\frac{1}{8}''$
Single sect. panel
1 side.

2175
x 4

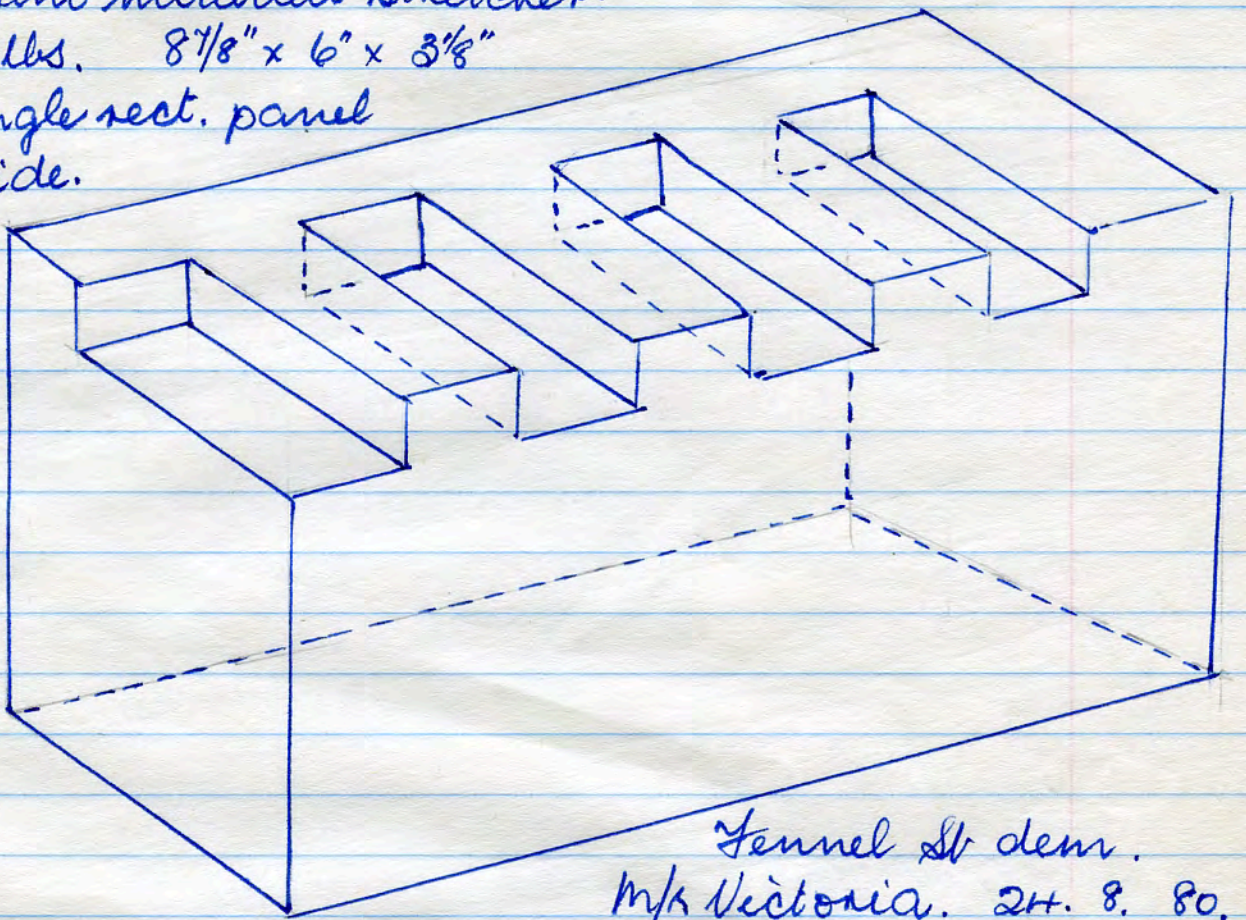

Fennel St dem.
Mk Victoria. 24. 8. 80.

Stretcher moulded return. 7 lbs.

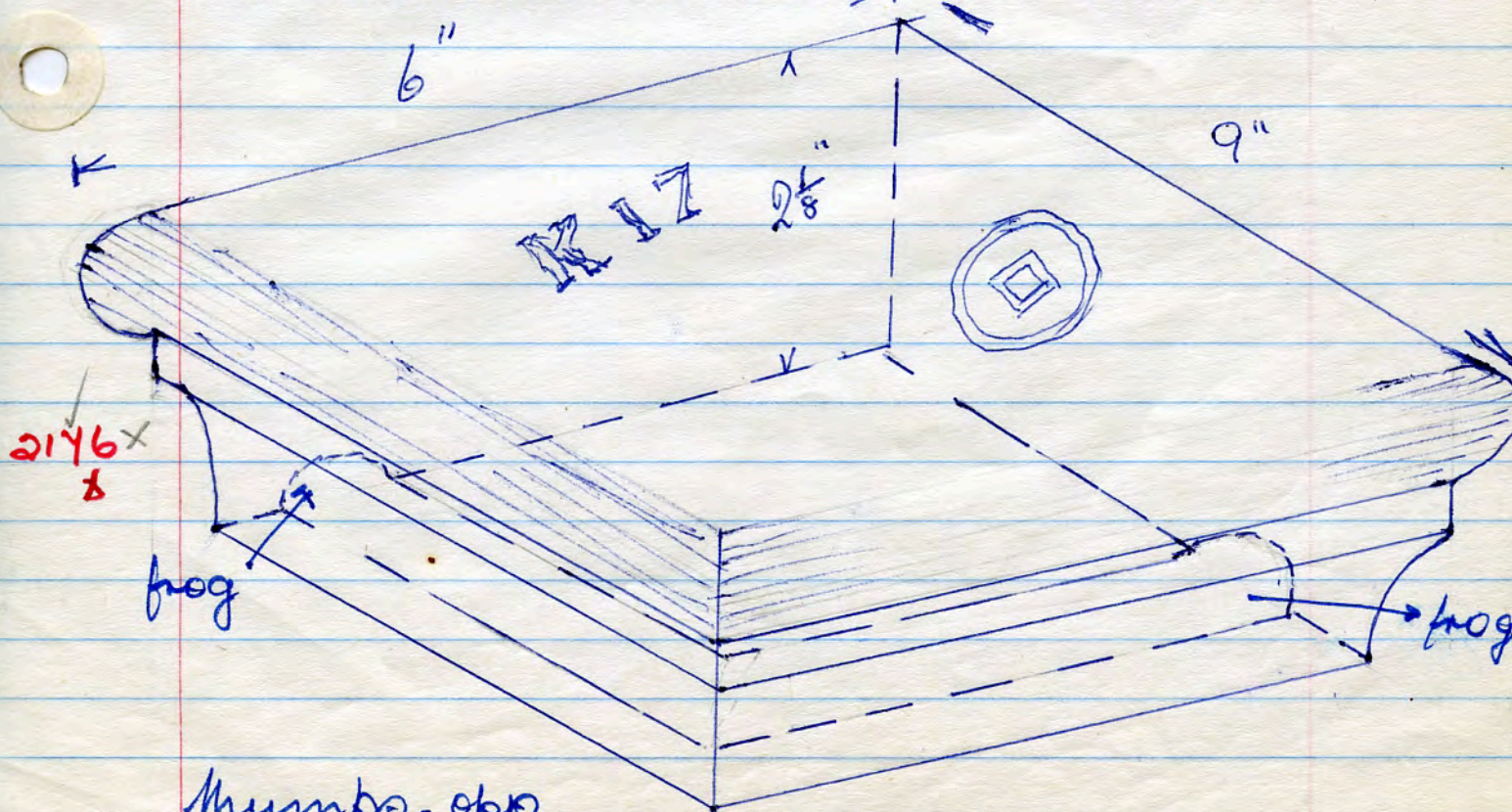

2176
x 8

Mumps. opp
"Footballers Arms" Oldham 14. 9. 80.

2144
x x

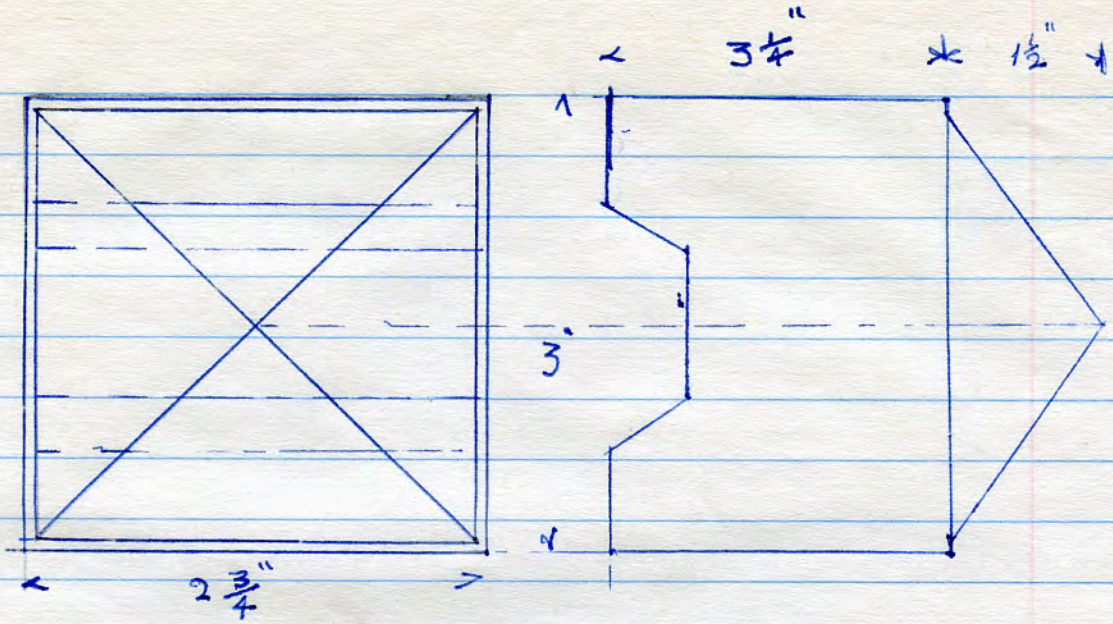

2 lbs. RYDER in relief, in base frog of Pyramid
dec. Stowell St. Waste Mfr. 17. 8. 80

2148 x
7

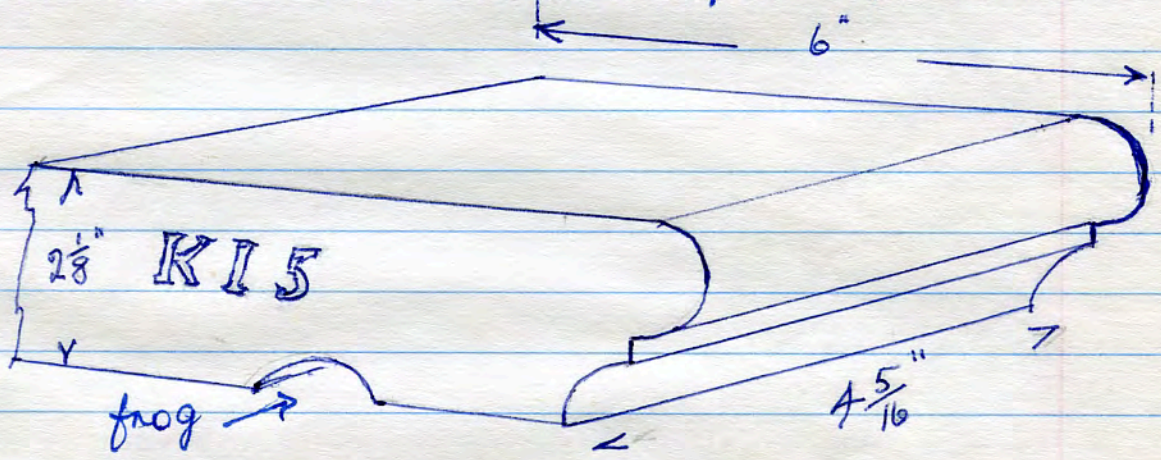

5 lbs. moulded header. Mumps, Oldham. 14. 9. 80.

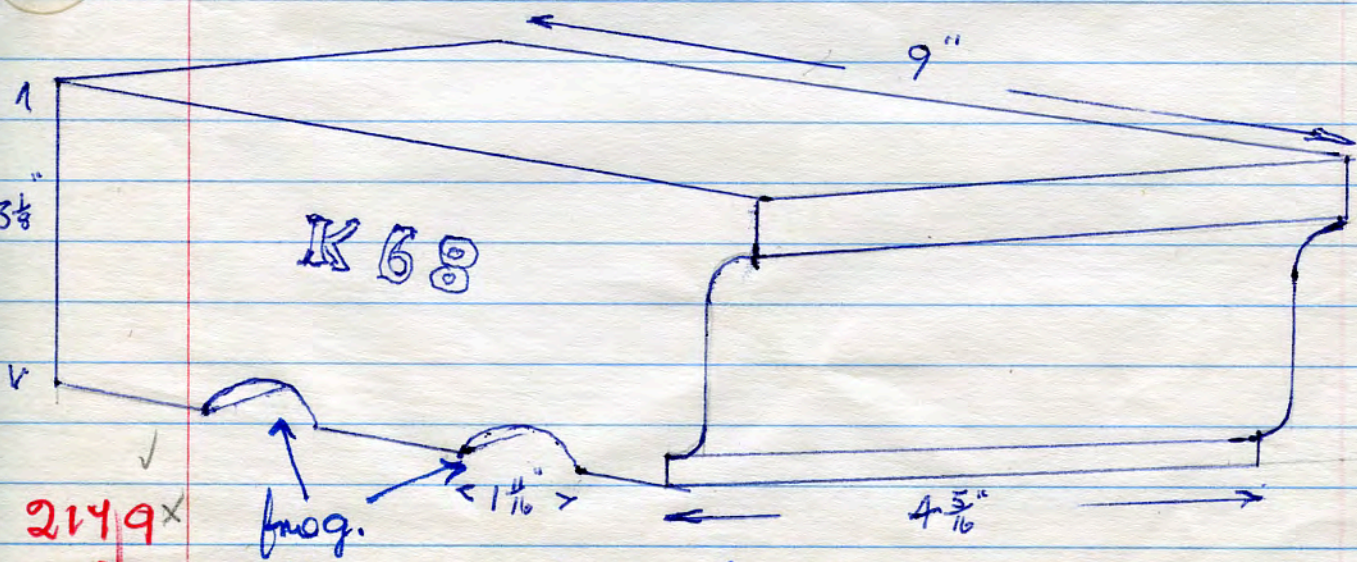

2149 x
7

9 lbs. moulded header.
Mumps - Footballers Arms, Oldham 14. 9. 80.

2180 x
y

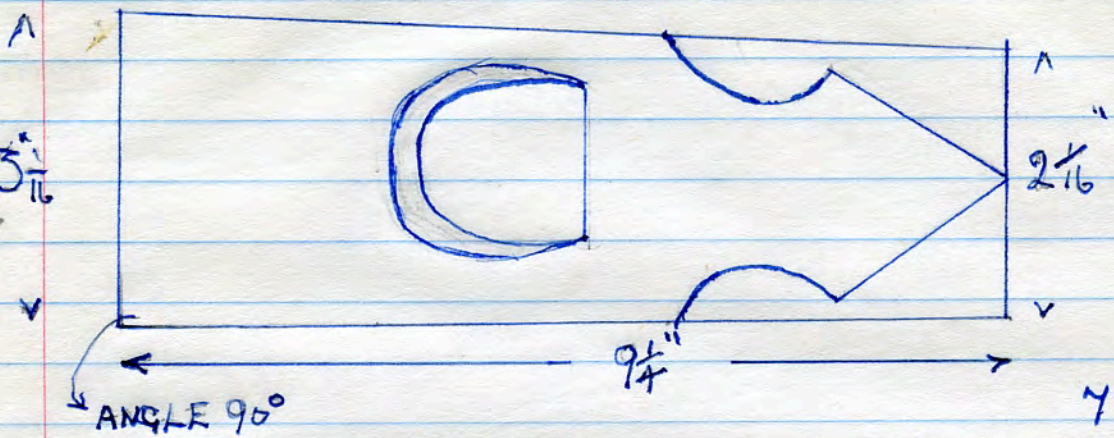

No name. Shoulded gauged starter brick, with small frog.

Stowell St. cottage dem. Waste m/r. 14. 8. 80

2181 x
y

G TRAUNTER. no panels, letters stamped 7 lbs.

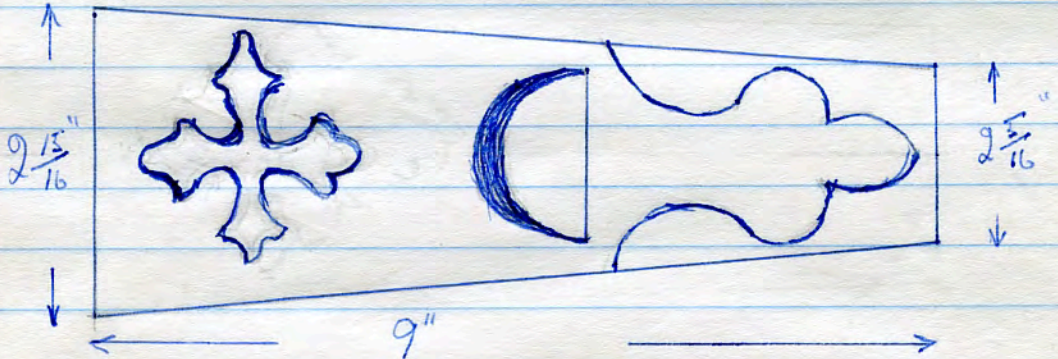

Stowell St. dem. Waste m/r. 14. 8. 80.

2182 x
y

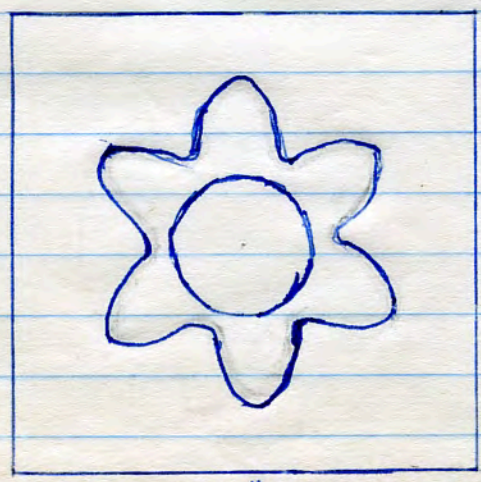

No name. 3 lbs. This is part of. ~~ass~~ common building brick. The motif is stamped in 1 end. On each side, part of pennant panel

Stowell St. Waste 14. 8. 80.

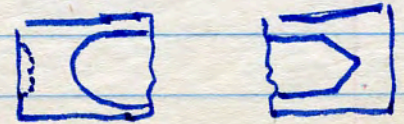

moulded jamb
brck. clay

2212^x

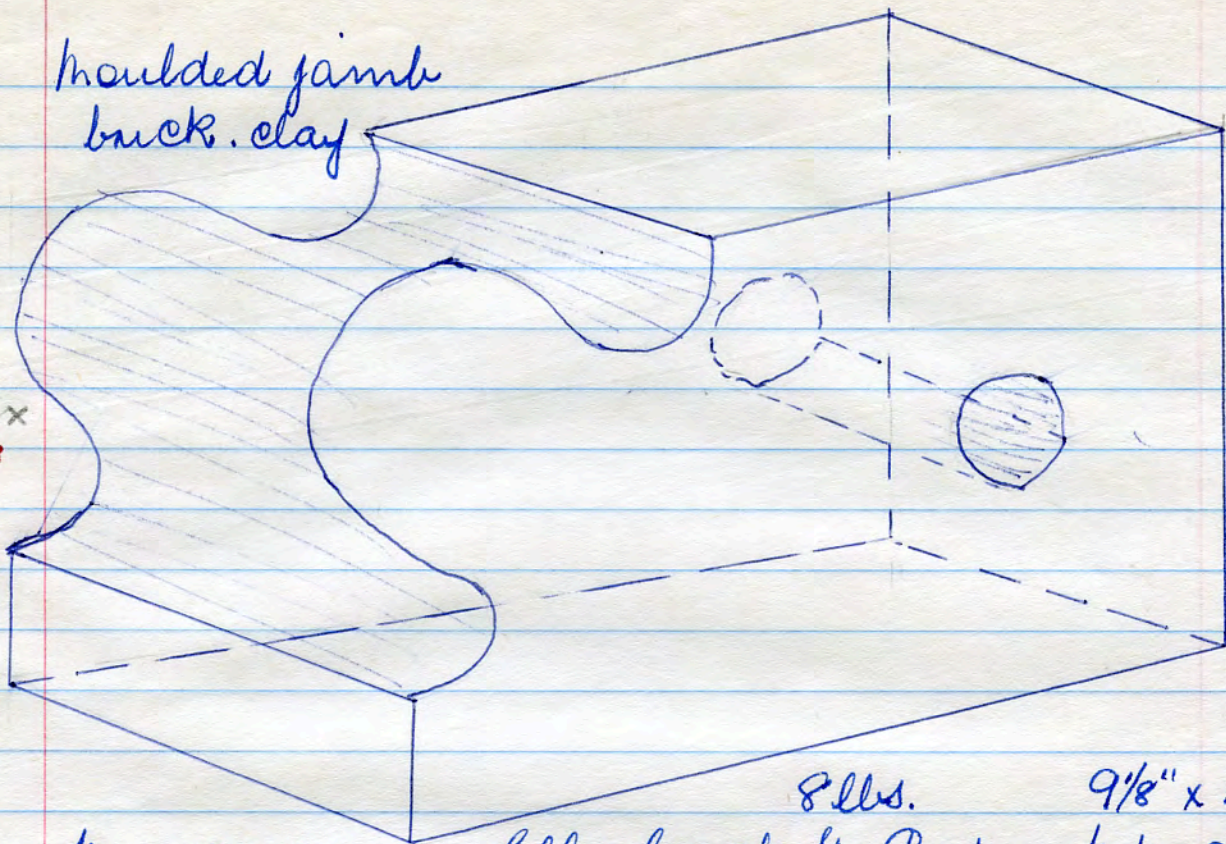

8 lbs.

9 1/8" x 4 1/2" x 3"

No name
no panel

Ellenbrook St. Boston Mfr. 28. 9. 80.

Red moulded stretcher
clay
No name

2213^x

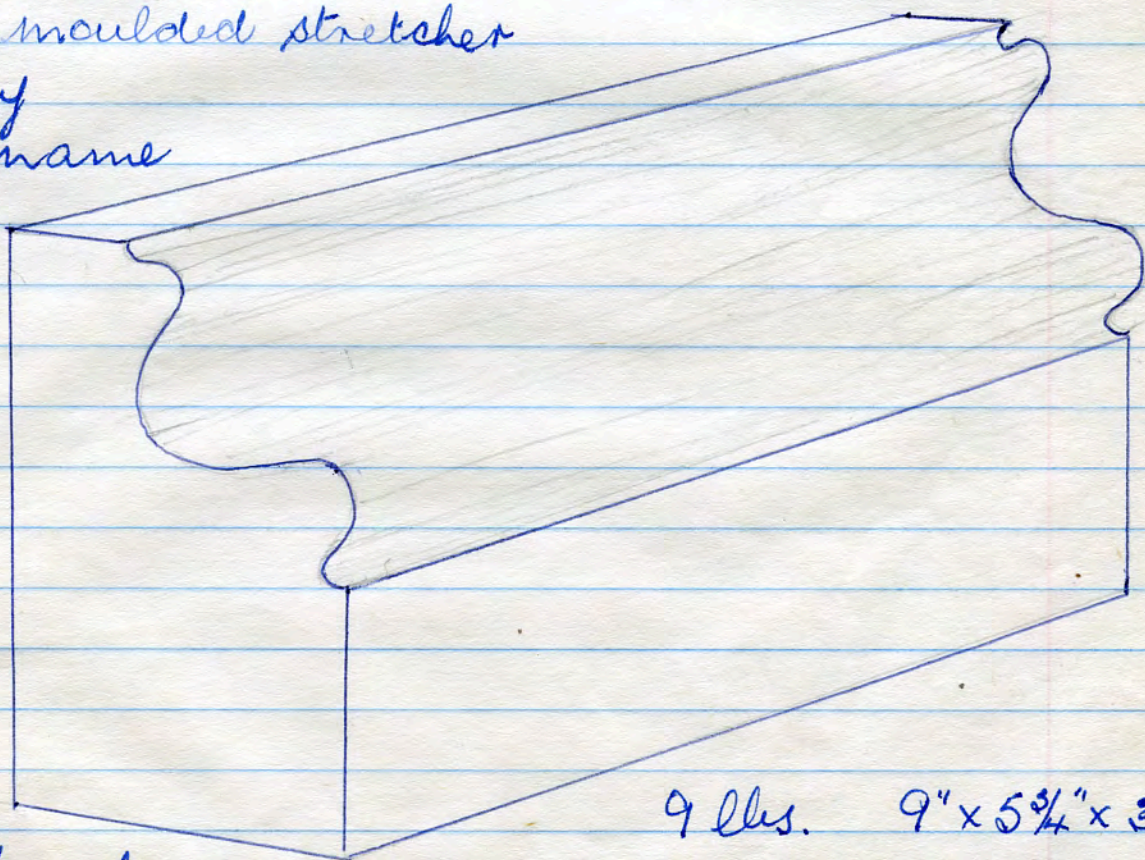

9 lbs.

9" x 5 3/4" x 3 1/8"

no panels.

Ellenbrook St. Boston Mfr. 28. 9. 80.

2214 ✓
✗ ✗

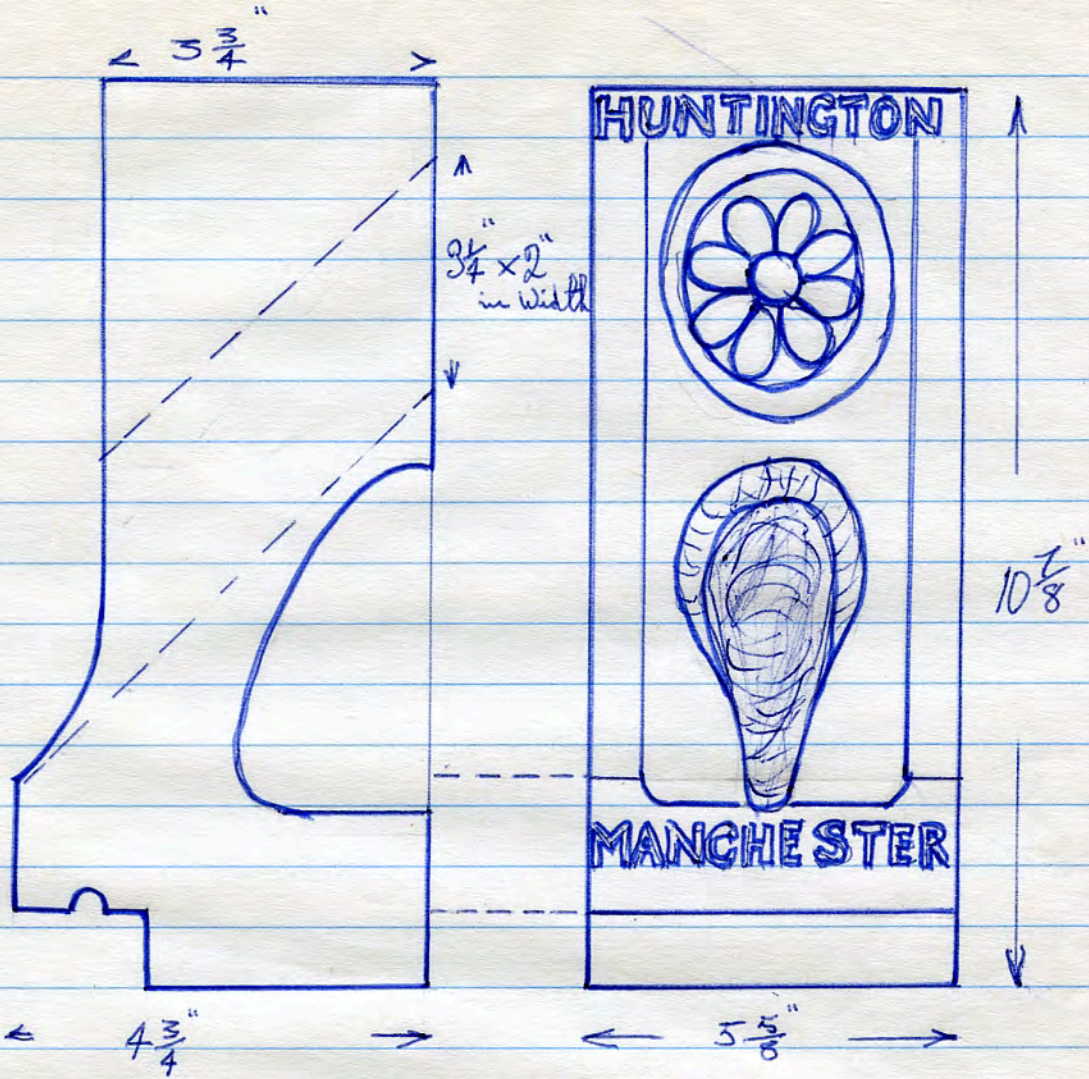

HUNTINGTON MANCHESTER. 15 lbs.
 fine clay spitzer, salt glazed. letters incised.
 Ellenbrook St. Boston. M/A. 28. 9. 80.

2215 ✓
✗ ✗

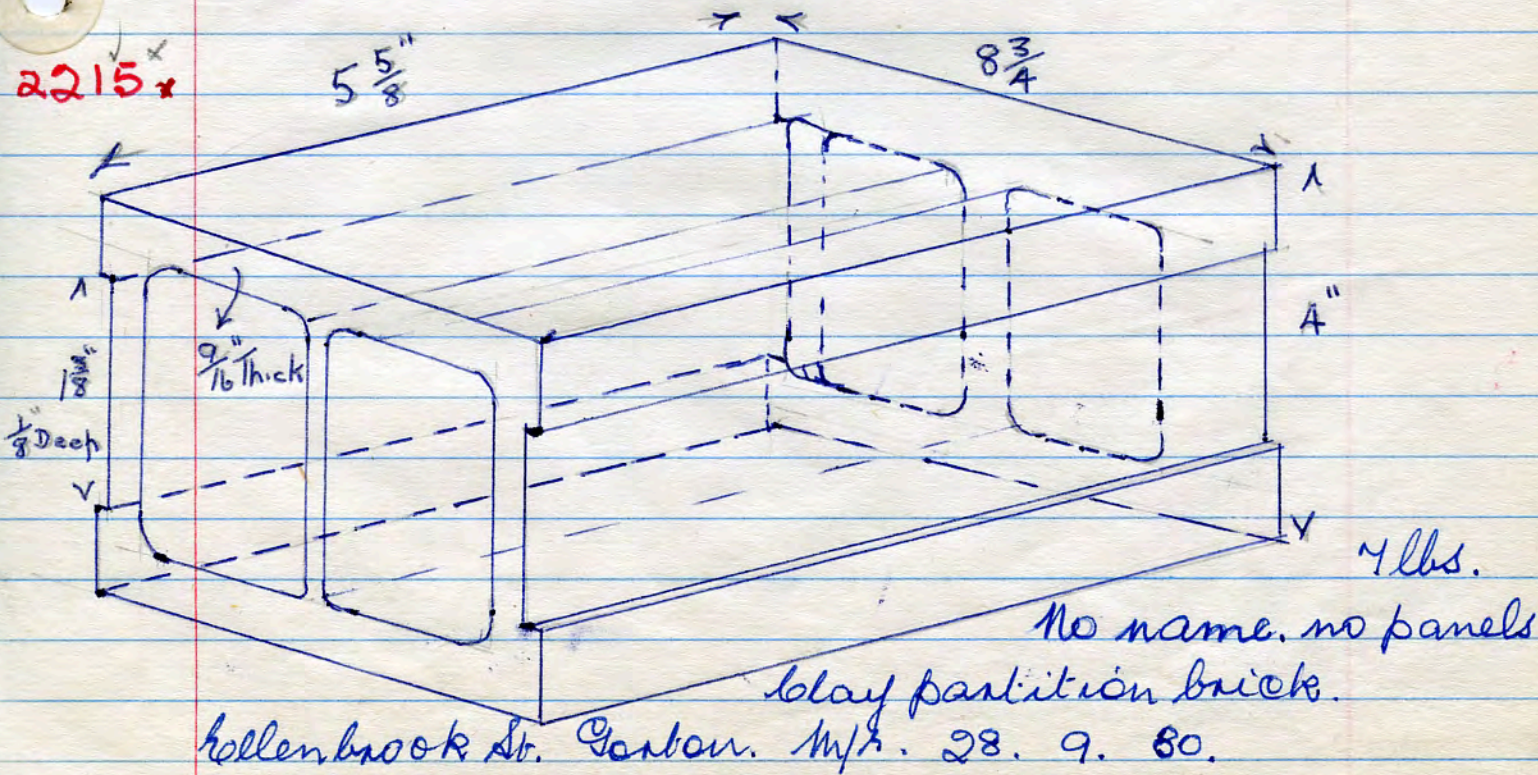

7 lbs.
 No name. no panels
 clay partition bricks.
 Ellenbrook St. Boston. M/A. 28. 9. 80.

No name. clay (red) wall capping
Ellenbrook St. Gorton, M/s
28. 9. 80.

2216 x

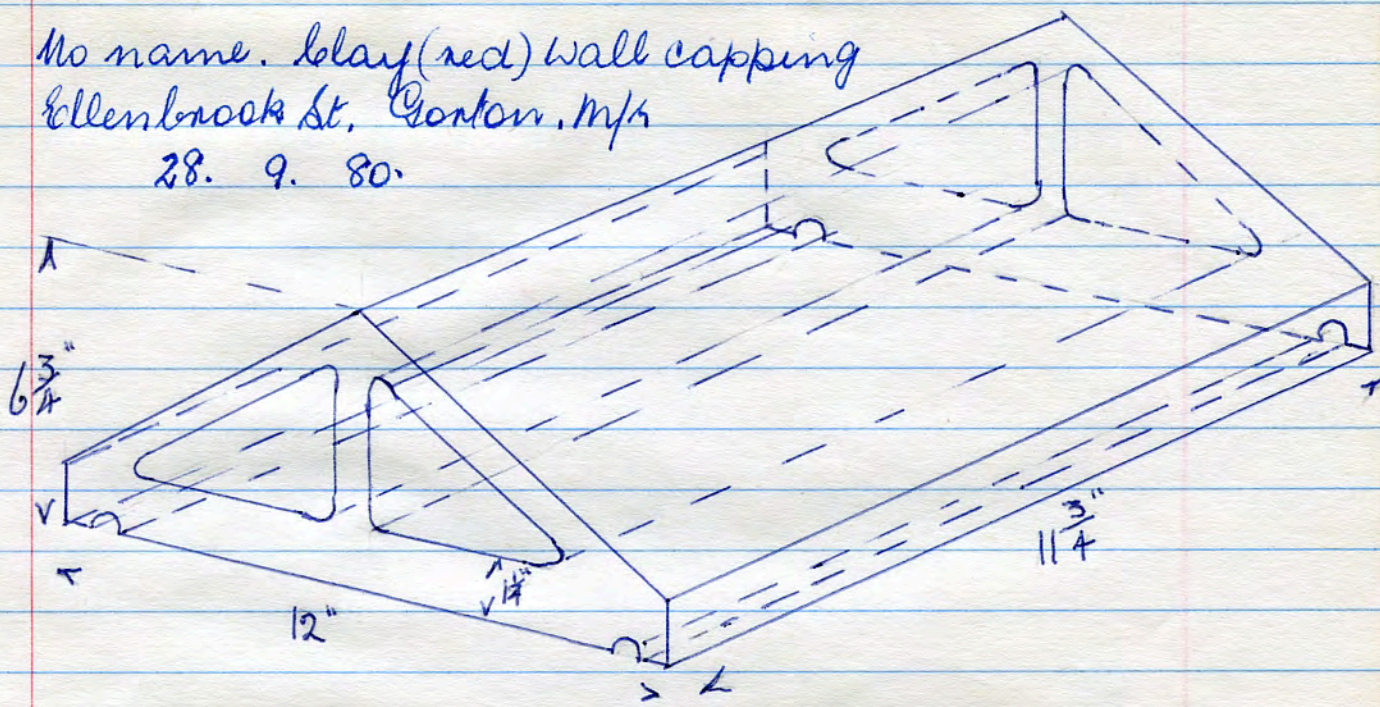

2217 x

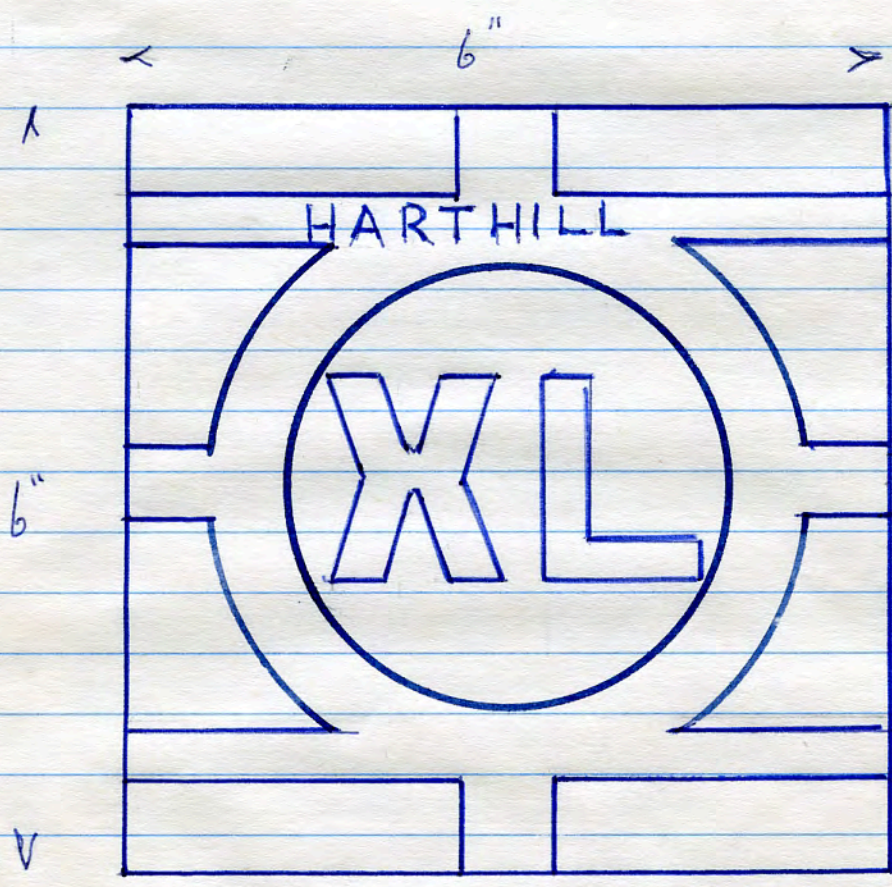

2 1/2 lbs
Blue floor tile
(quarry)

$\frac{15}{16}$ Thick

Ellenbrook St. Gorton. 28. 9. 80

no name. Pant spitter, brown salt glaze.

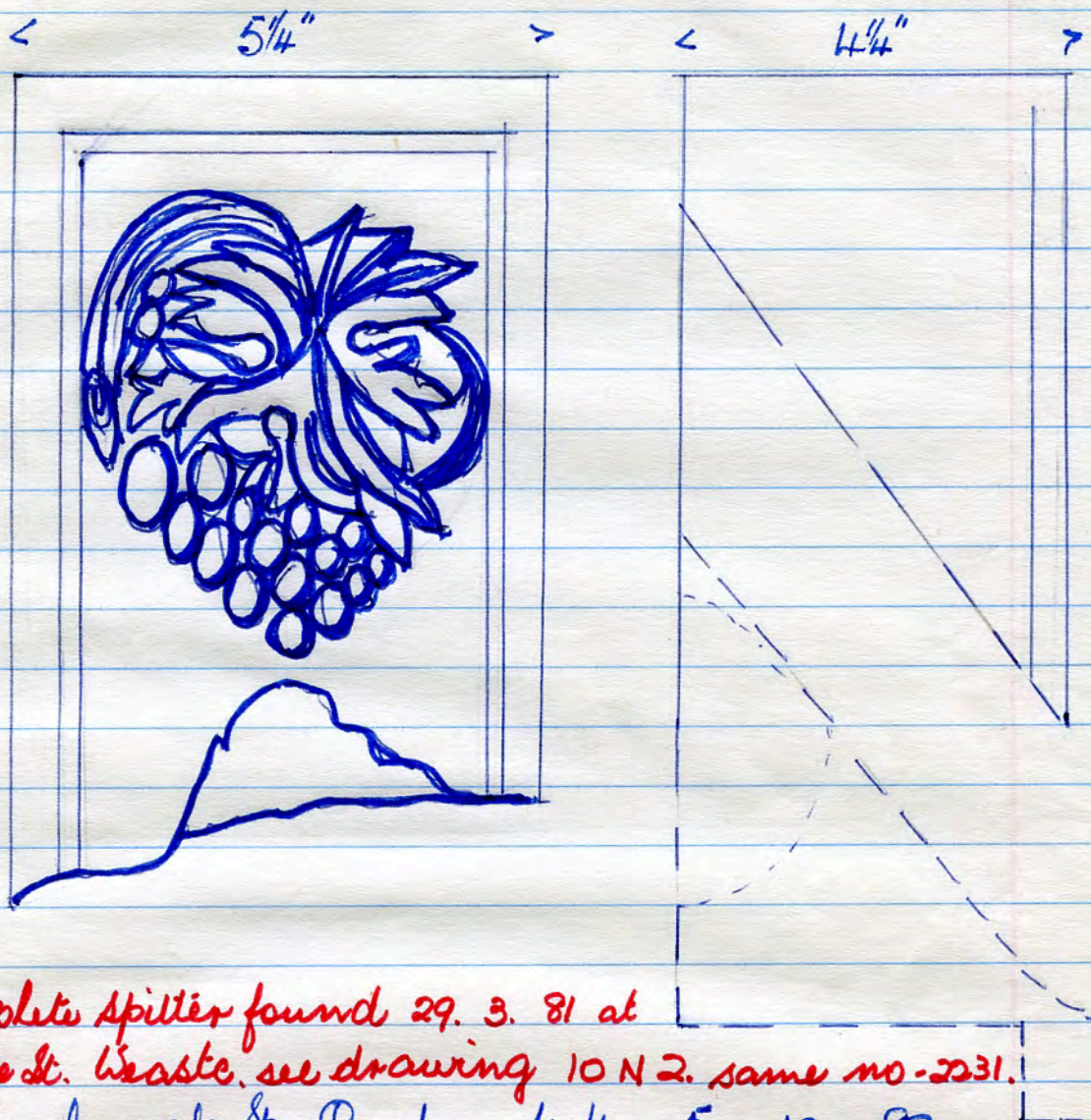

2231*

complete spitter found 29. 3. 81 at
Guide St. Waste, see drawing 10 N 2. same no-2231.
Ellenbrook St, Boston Mfr. 5. 10. 80.

DOULTON LAMBETH cream, decorative string
course brick, nail head pattern (3)
6 lbs. 8 3/10" x 4" x 3".

2232*

cavity in base. 7 1/4" x 1 1/2" x 2 3/4" deep.
Temperance St. (tip) H. Andwicks Mfr. 5. 10. 80.

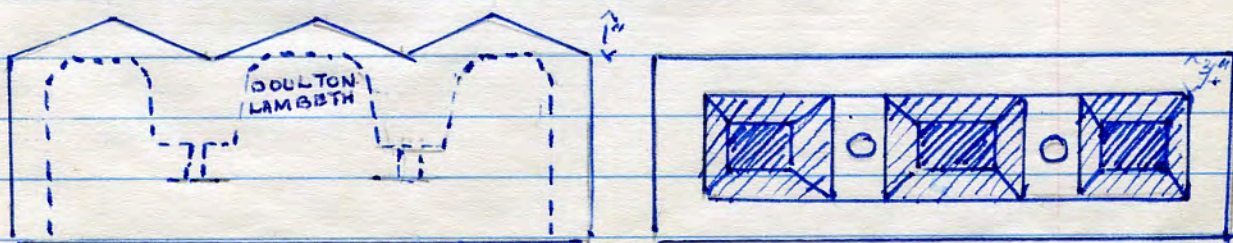

Red wall capping
43 lbs.

LENGTH $12\frac{3}{16}$ "

2236
x

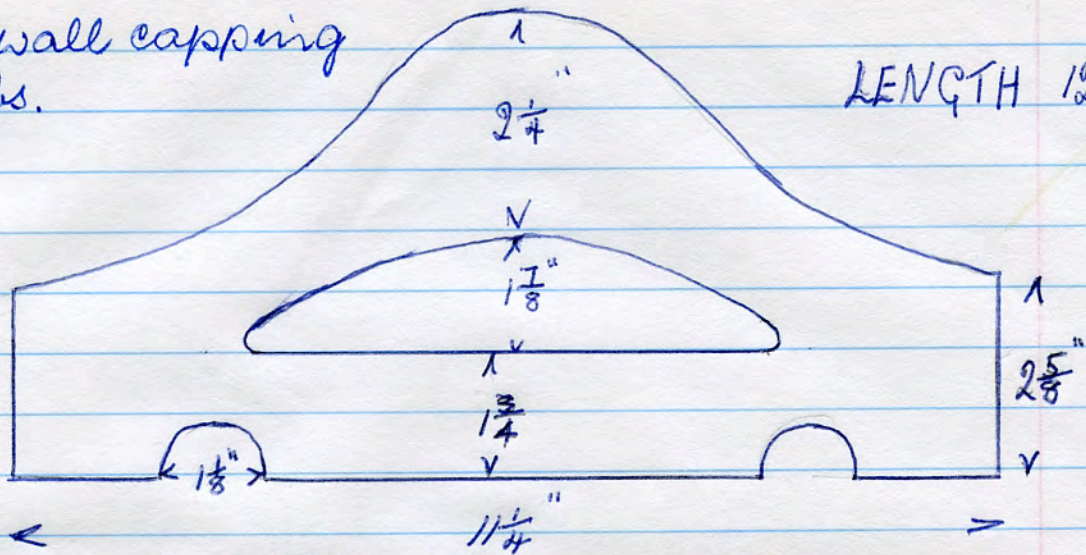

Hartford Mill, Oldham. 14. 9. 80

Red wall capping
35 lbs.

LENGTH $12\frac{1}{4}$ "

2237
x

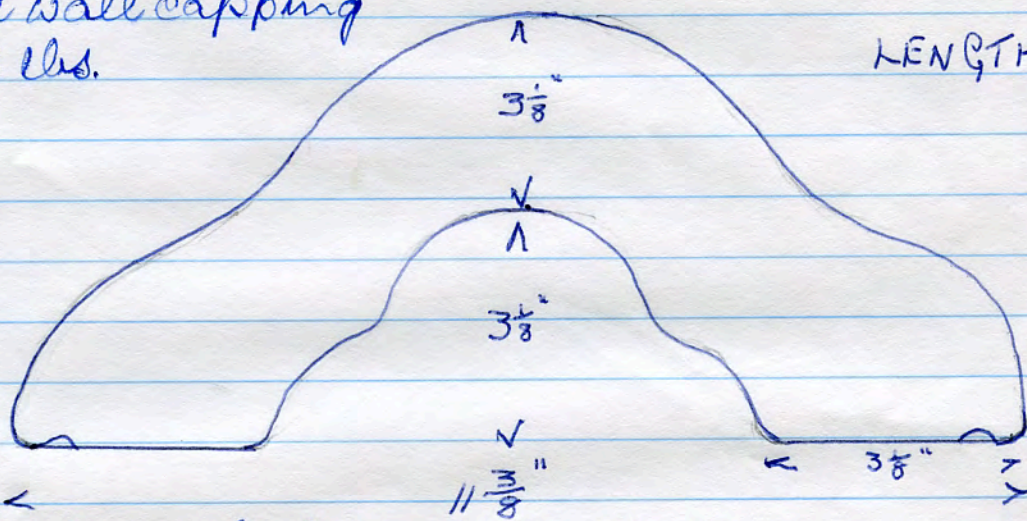

Ellenbrook St. Bolton 5. 10. 80.

LENGTH 12"

Red wall capping.
35 lbs.

2238
x

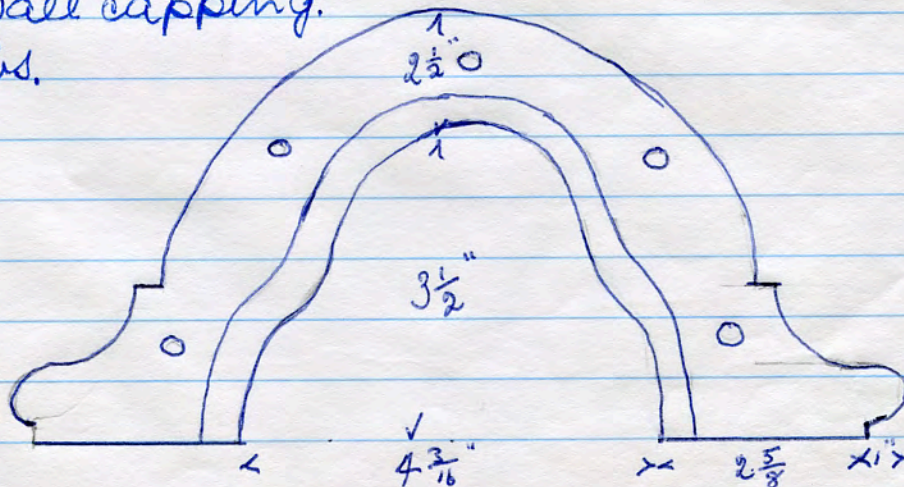

Montford St. Weaste M/s. 14. 8. 80.

Red wall capping
35 lbs.

LENGTH $11\frac{3}{4}$ "

2239
x x

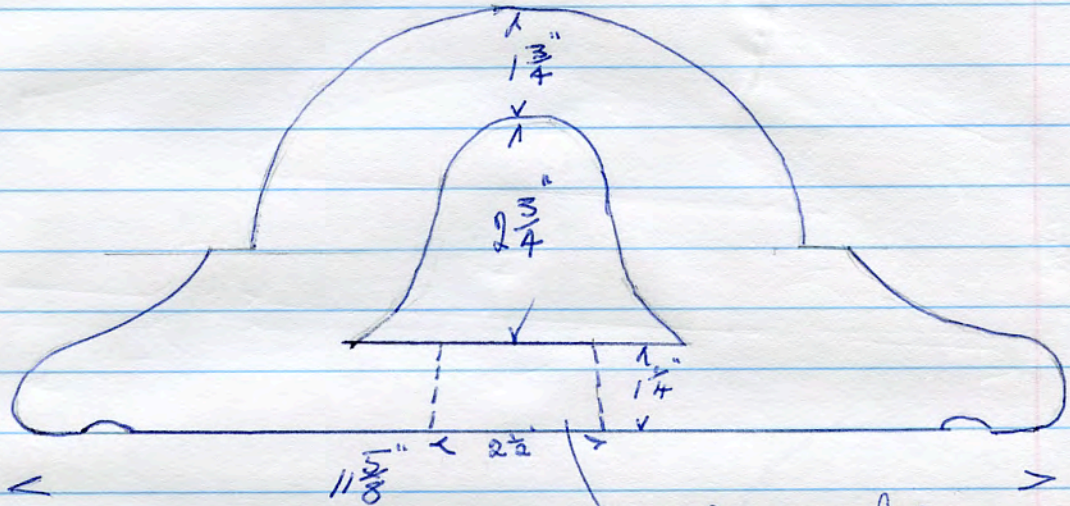

Ellenbrook Dr. Boston 28. 9. 80. Circular hole acting as a frog in Centre of Tile

Red wall capping. FS 8. Length $9\frac{3}{4}$ " Height $8\frac{3}{4}$ "
42 lbs. Width. 9"

Junction of Bollyhurst Rd. Rochdale Rd (dem) 12. 10. 80.

2247
x x

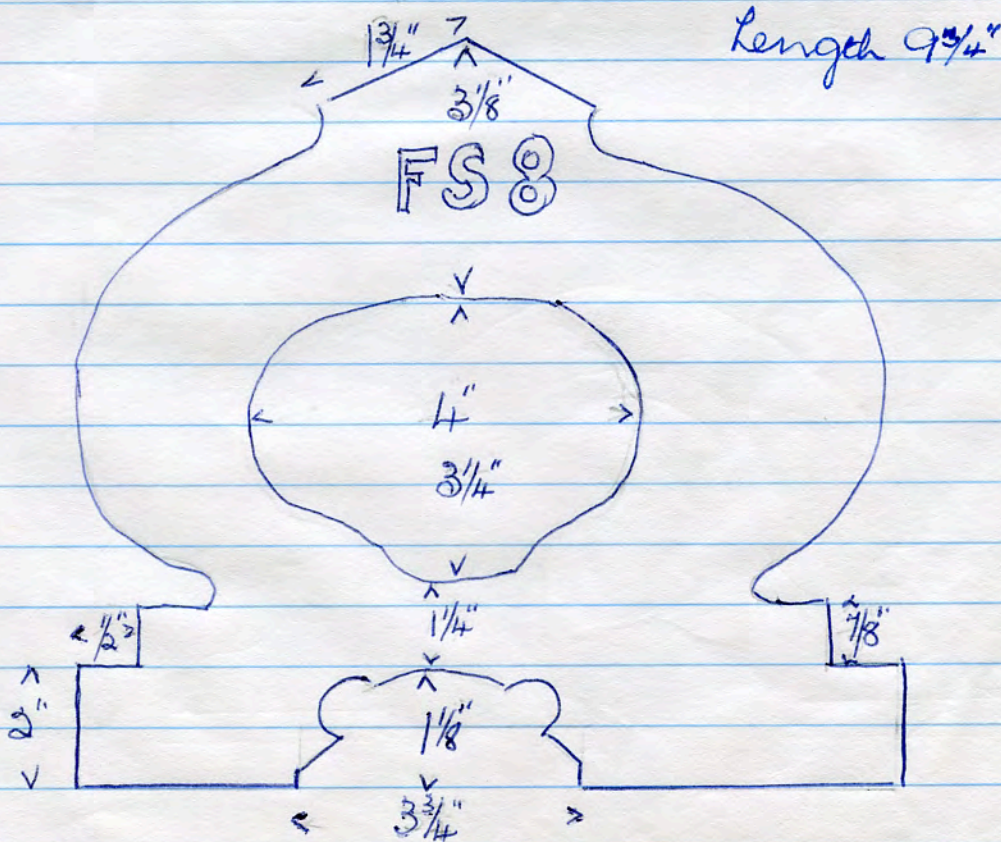

2248
x x

As above design but 12' long - bearing a piece of metal in lead run.

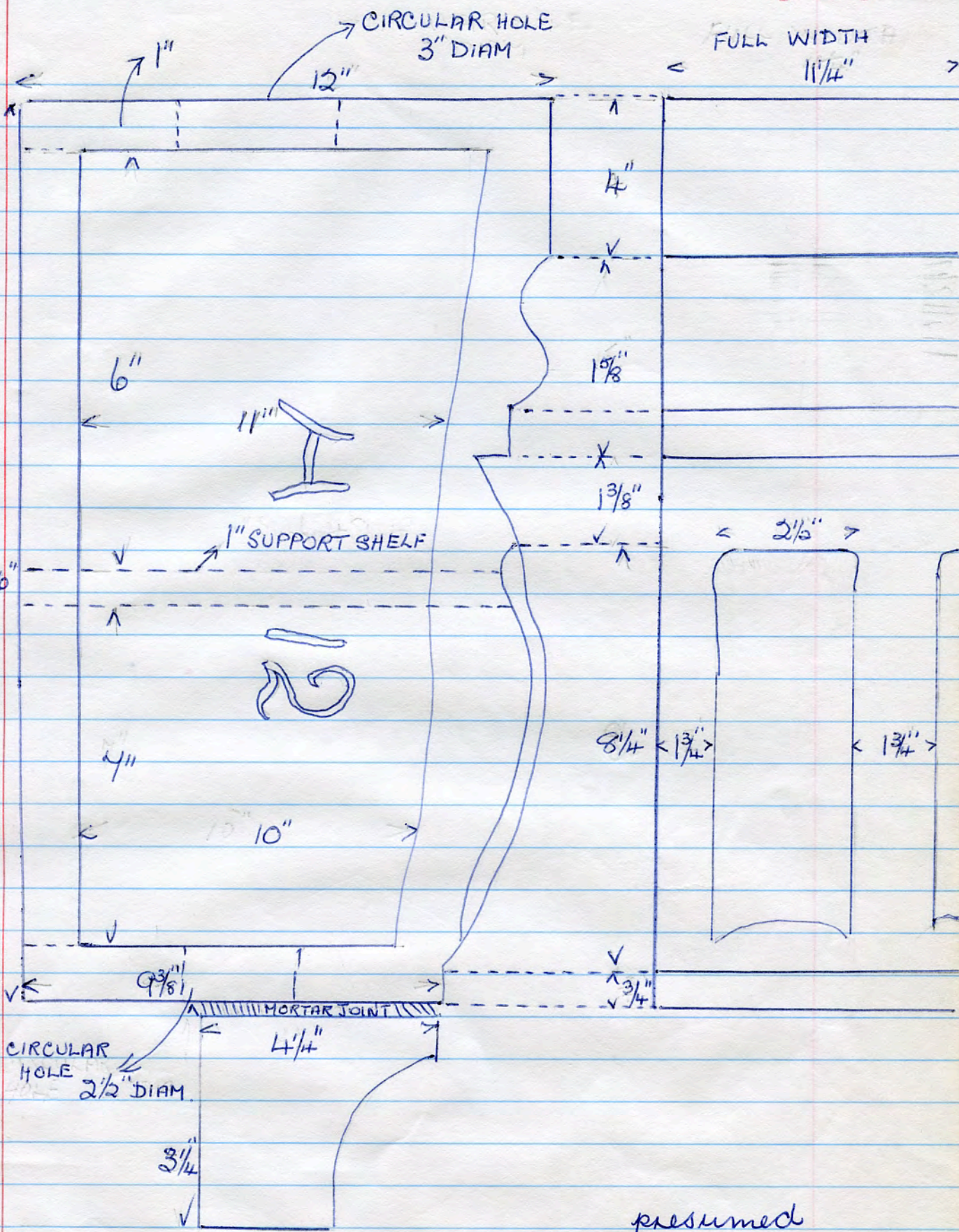

3249

presumed

Pilaster head in terra cotta. (Monk + Hewell Ruabow)
 Tunnel St dem. W/4. 24. 8. 80.

ELECTRIC CABLES LV

21 lbs. $12\frac{5}{8}'' \times 12'' \times 2\frac{1}{8}''$

no panels, letters incised

Gay St dem. Bollyhurst M/s. 19. 10. 80.

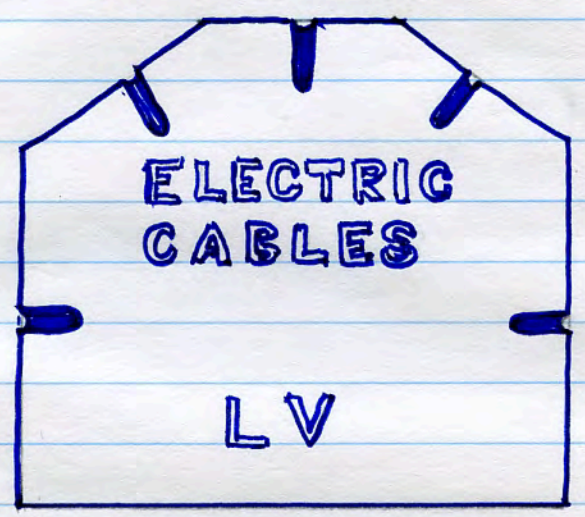

2282*

No name. (J.C. EDWARDS?) jamb brick. red.

9 lbs. $9'' \times 4\frac{3}{8}'' \times 3\frac{1}{8}''$

no panels. 1

Long Millgate dem. M/s Nick. 9. 11. 80.

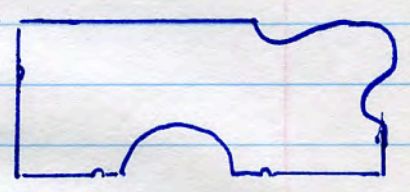

2288*

Decorative string course brick. red. 6 lbs.

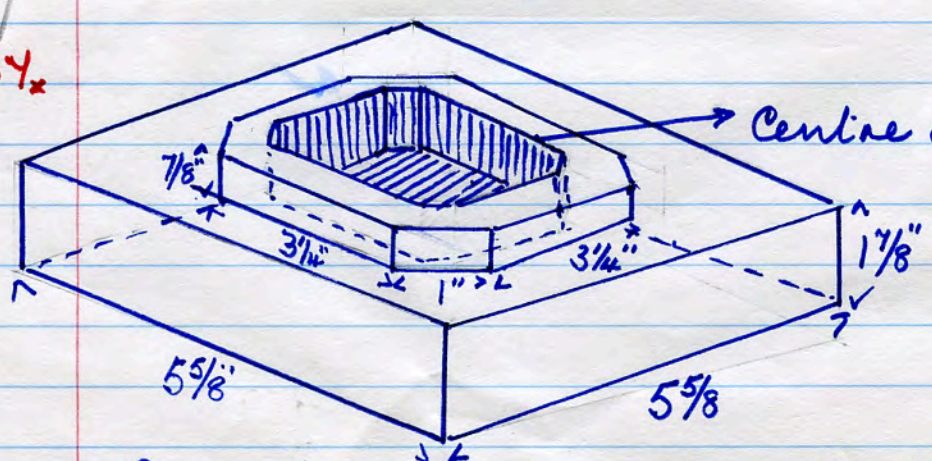

Centre depth $\frac{3}{4}''$ $2\frac{1}{4}'' \times 2\frac{1}{4}''$

Panel in reverse $3\frac{1}{4}'' \times 3\frac{1}{4}'' \times \frac{3}{8}''$

No name. (probably W.F.T.M.B.W BOLTON)

William Fletcher, Tonge Moor Brick Works

High Newnham Street dem. Bolton. 7. 12. 80.

2338*

as 2337 above but with centre depth $1\frac{1}{4}''$

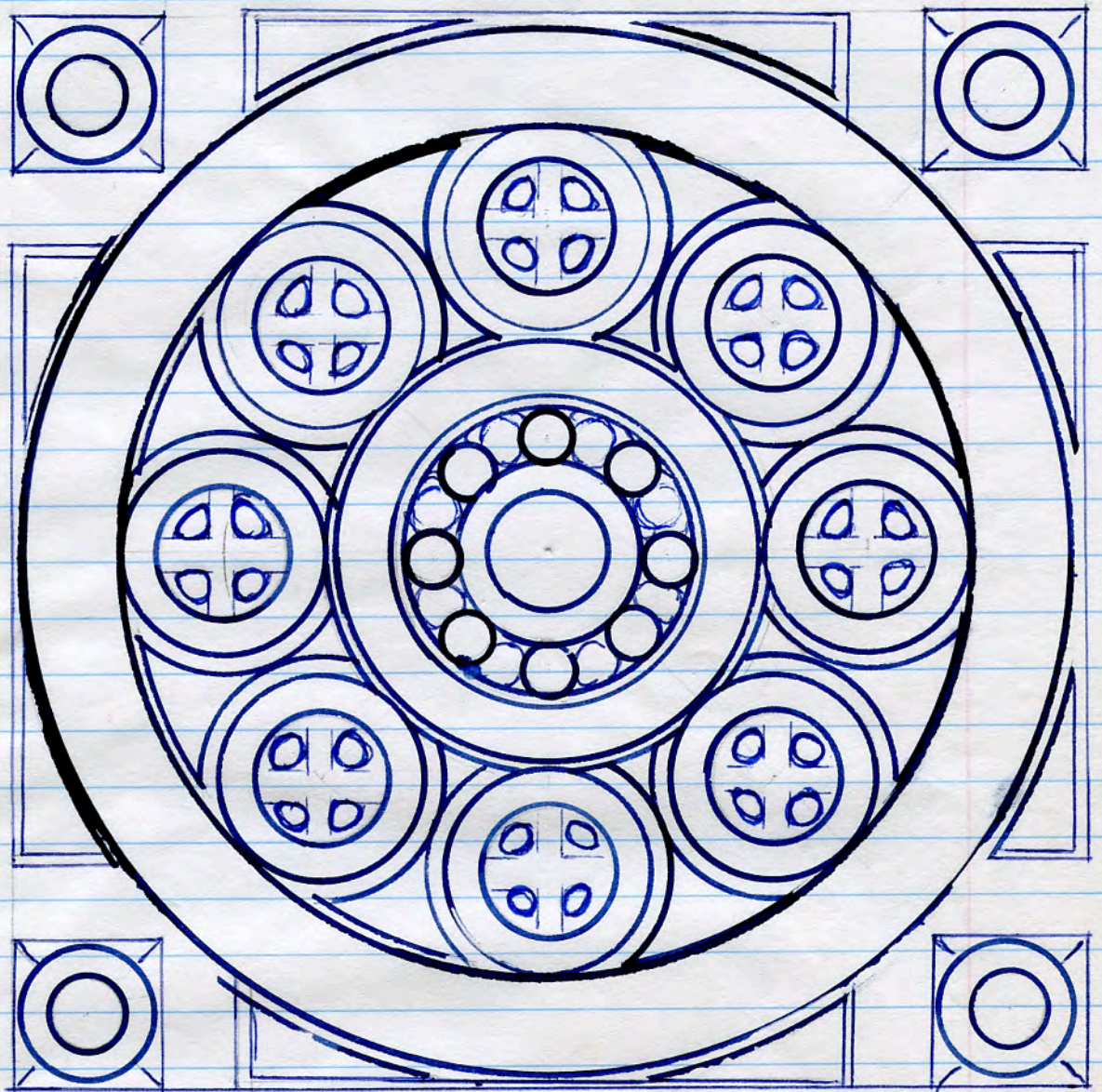

2242
x x

14 lbs.

10" x 10" x 4½"

Decorative air vent. No name (in same building
as J. C. EDWARDS RUABON bricks). 4 storey dem.
Long Mullen Gate, Victoria, M/V. 19. 10. 80.

Decorative terra cotta piece for window or doorway.
 Wynne Street (school dem.) Frederick Rd. Wallness 9. 11. 80.

16 L5

2339
x

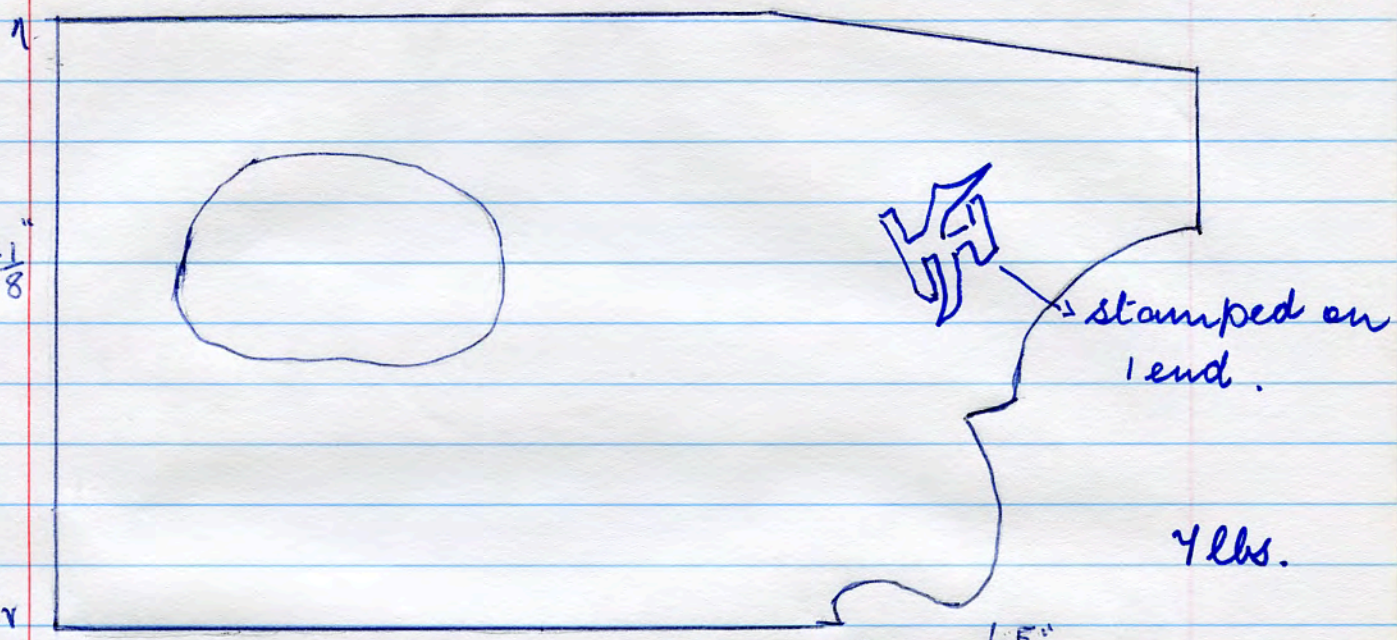

bamboo in length of $6\frac{1}{8}'' = \frac{1}{16}''$
 C II 7 stamped on top

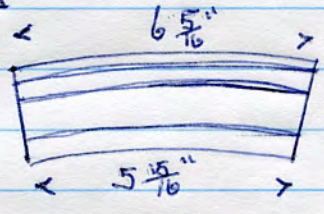

2340
x

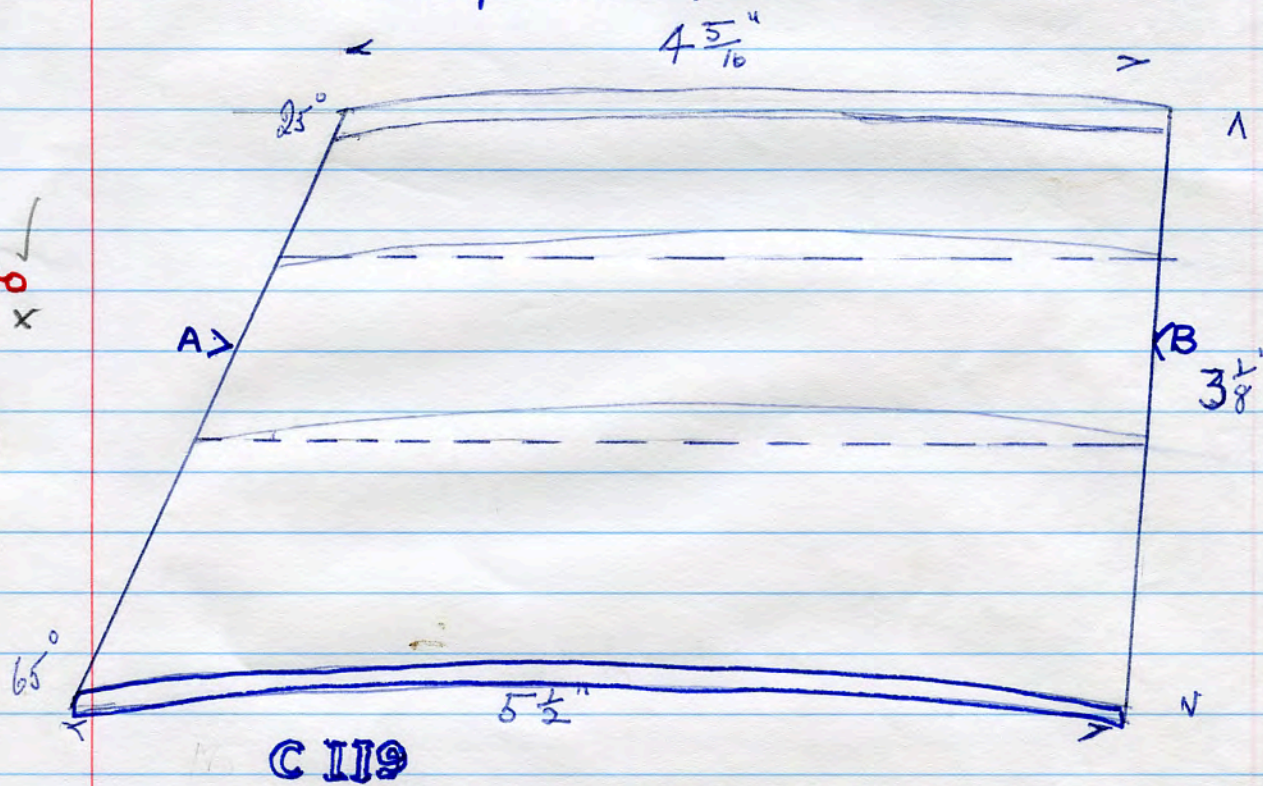

same moulding as 2339 above. 5 lbs
 circular perf. - $1\frac{1}{2}''$ diam. from A - B.
 Both pieces presumed to be by J. C. EDWARDS, RUABON
 found with many other named pieces on same site

Decorative stretcher. No name. (presumed JABEZ THOMPSON - others found on same site). Red Bank, M/s. 2. 11. 80.

FRONT ELEVATION

SECTION $4\frac{3}{8}$ "

✓
2341
x

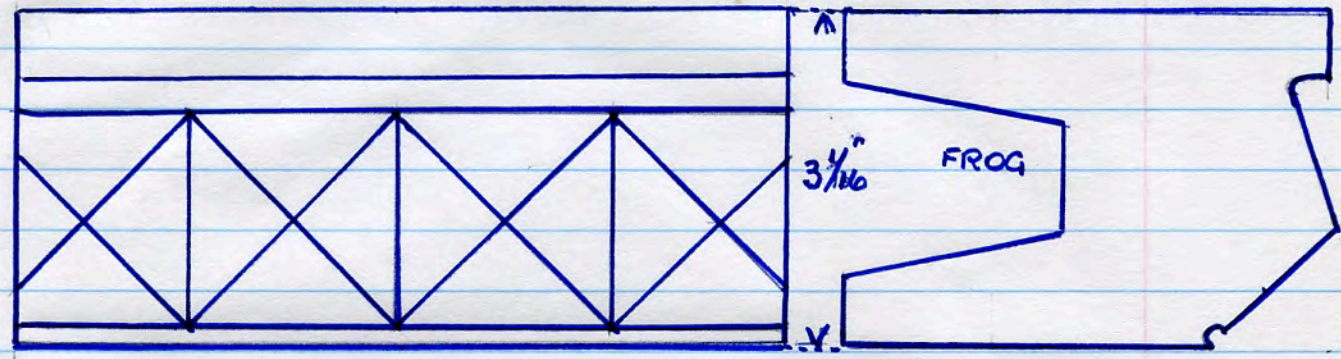

5 lbs.

✓
2342
x

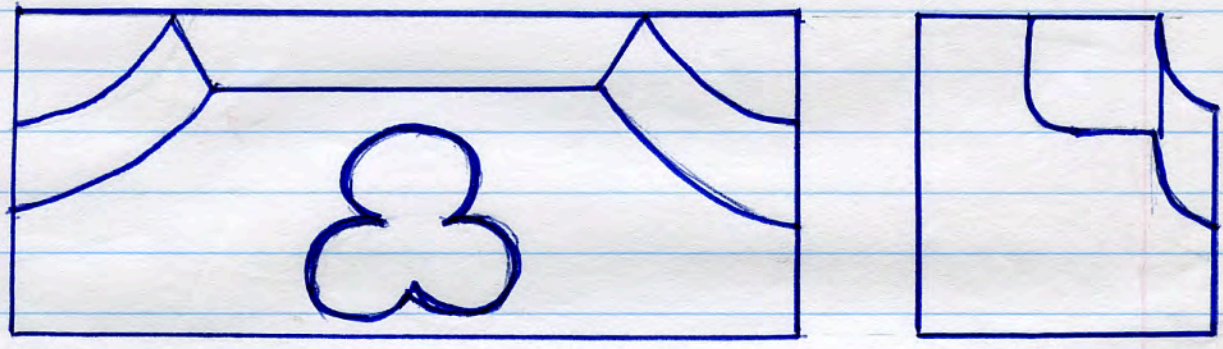

JABEZ THOMPSON TERRA COTTA WORKS NORTHWICH
Stamped on top
7 lbs.

Decorative terra cotta string course.
Sovereign Road dem. Wigan. 9. 11. 80.

✓
2347
x

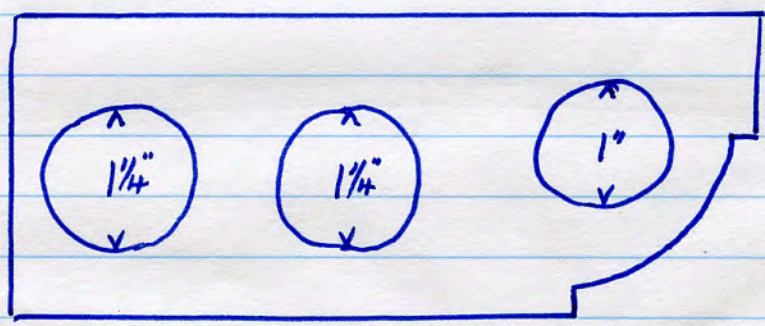

No name, no panel. (presumed JABEZ THOMPSON)
Decorative terra cotta header
6 lbs 9" x 4 1/2" x 3"
3 perfs. through 2 x 1 1/4" diam. 1 x 1" diam.
Sovereign Road dem. Wigan. 9. 11. 80

✓
2348
x

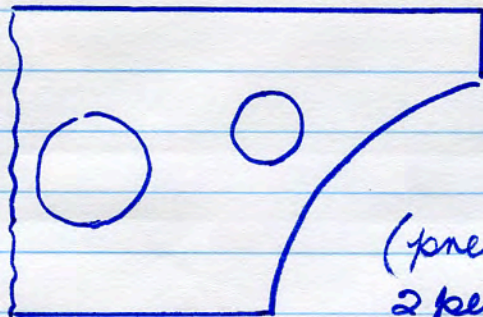

Decorative terra cotta header
no name, no panels.

5 lbs. 6 3/4" x 4 1/2" x 3"

(presumed JABEZ THOMPSON).

2 perfs. 1 x 1 1/4", 1 x 3/4"

Sovereign Road dem. Wigan 9. 11. 80.

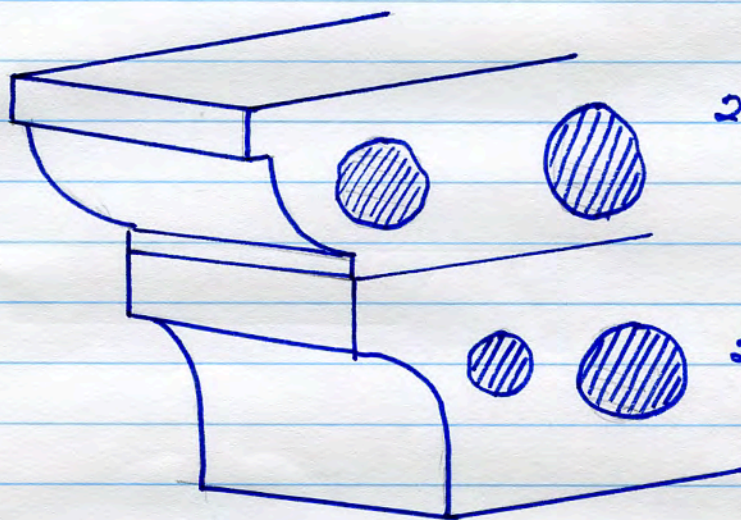

2347

} In use
together

2348

no name SB 4x6 Key stone for flat arch, terra
17 lbs. cotta,

presumed
J C EDWARDS
RUABON

letters & nos. incised

✓
2349
x

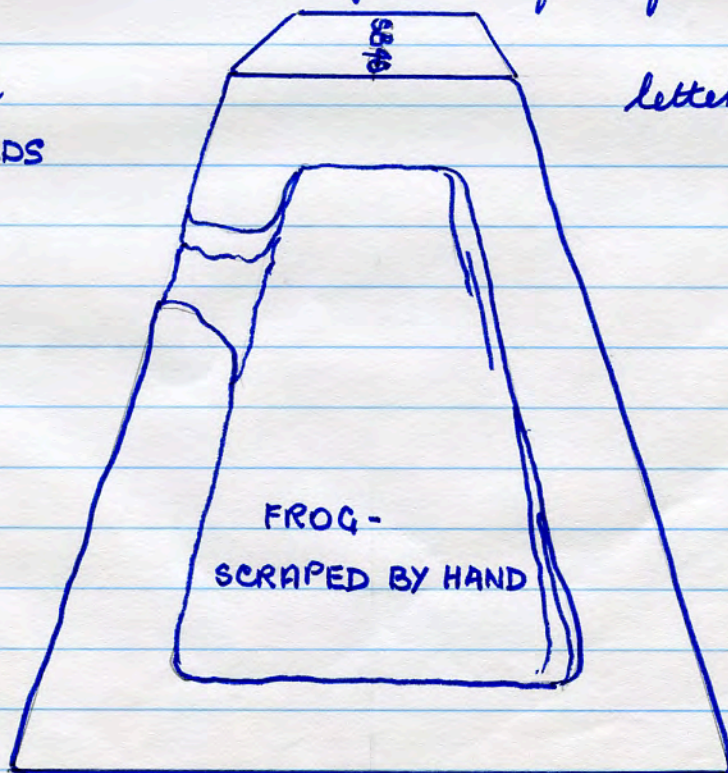

Wymre St school dem. Frederick Rd. Wallness M/P. 9. 11. 80.

16.0.5
2351

2350

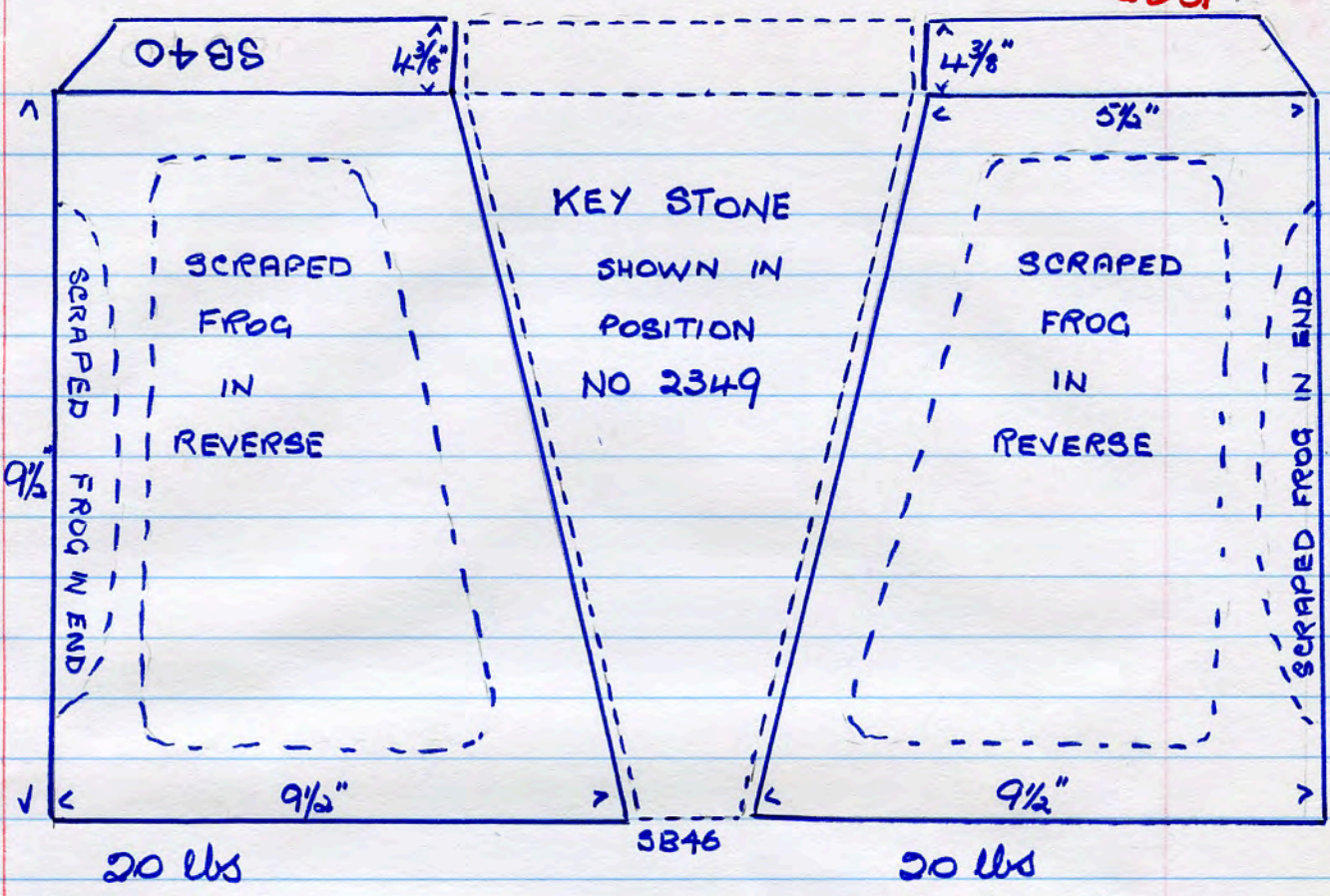

SB 41 stamped on this end.

No name. (presumed J C EDWARDS RUABON)
 Wynne St. school dem. Frederick Rd. Wallness M/r.
 9. 11. 80.

2352

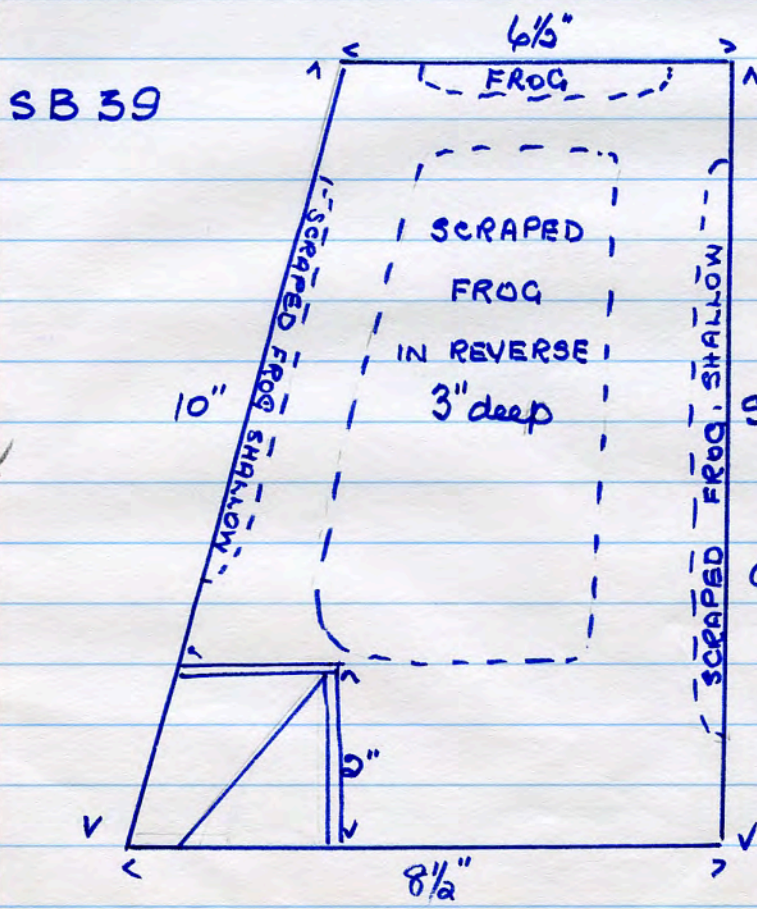

Decorative TC corner of
 31 lbs door or window.
 SB39 stamped on this side

No name (presumed J C EDWARDS RUABON)
 Wynne St. school dem. Wallness M/r. 9. 11. 80

SB No name. TC window or door jamb. (decorative)
 11" x 4" x 2⁷/₈" 14 lbs.

2353

(presumed J C EDWARDS RUABON).

single panel each side
 letters stamped 1 side only

Wynne St. Wallness h/r. 9. 11. 80.

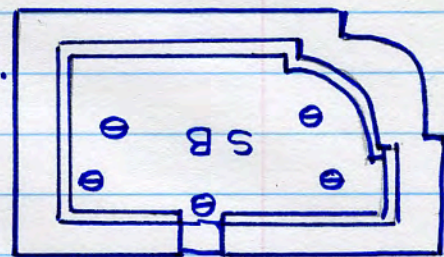

SB 65 No name. T.C.

9⁵/₈" x 4⁷/₈" x 4¹/₂" 14 lbs.

1/4" square perf throughout.

stamped SB 65 one end, SB 66 the other

. 3" x 2¹/₂" frog each end.

Wynne St. school dem. Wallness h/r. 9. 11. 80.

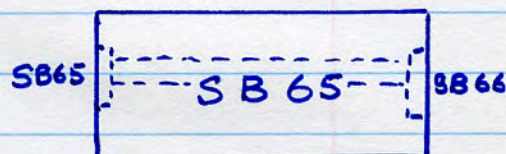

2354

C4 No name. moulded T.C. projection with return
 oval mould. (presumed J C EDWARDS RUABON).

14 lbs.

2355

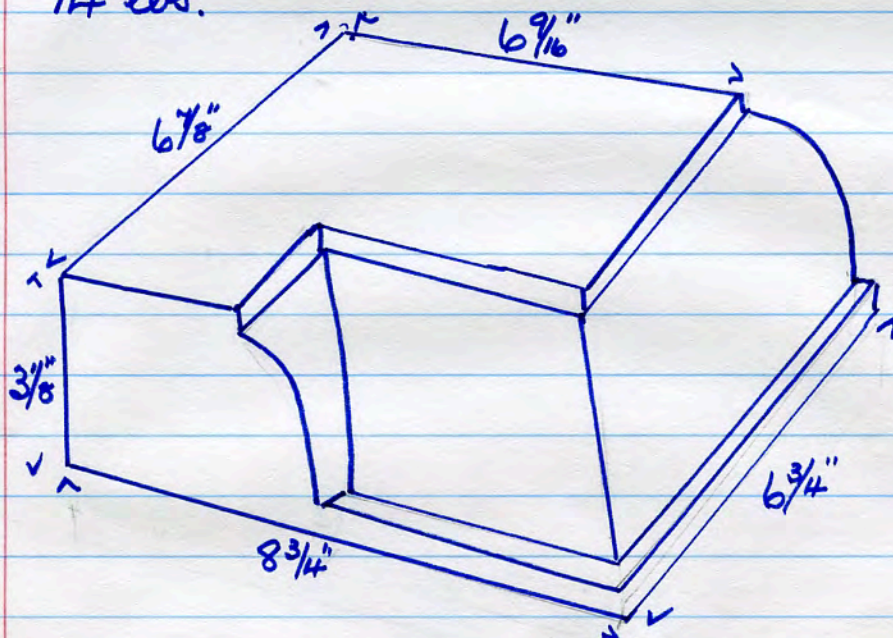

Long Millgate (4 storey dem) Victoria h/r. 0

SBC No name (presumed J.C. EDWARDS, RUABON)
48 lbs.

2356
x

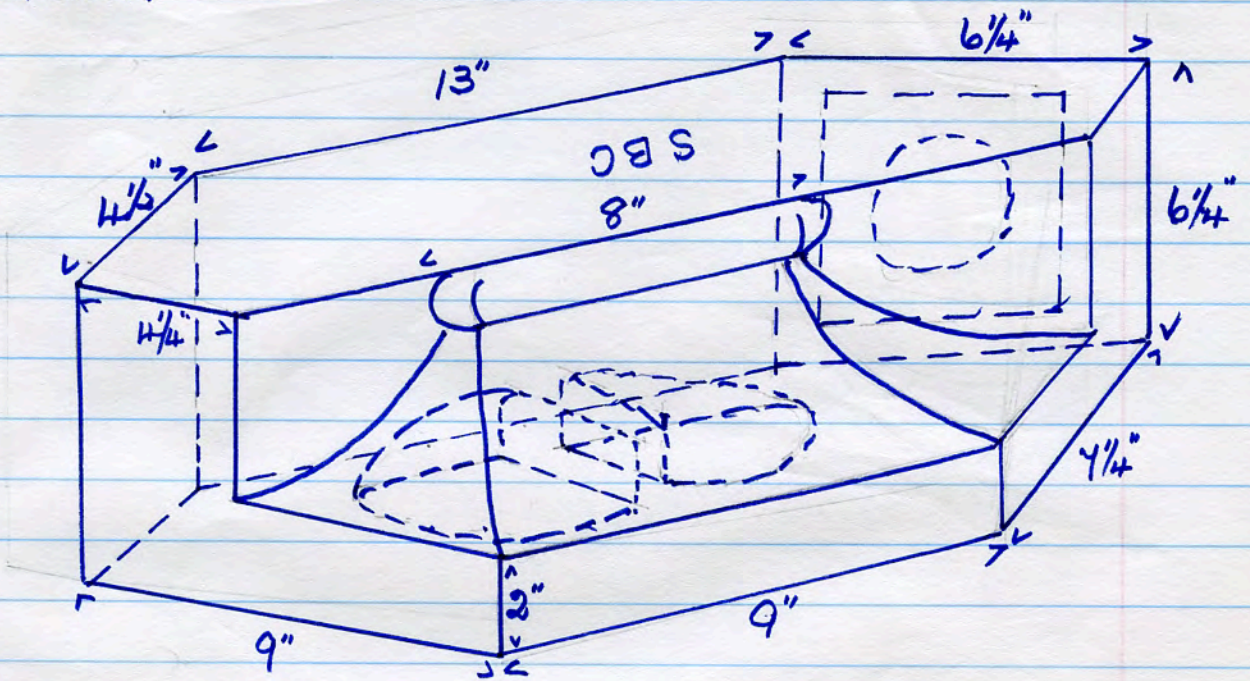

Wynne St. School dem. Wallness Wn. 9. 11. 80

No name. Blue ridge tile. 45° pitch.

2364
x

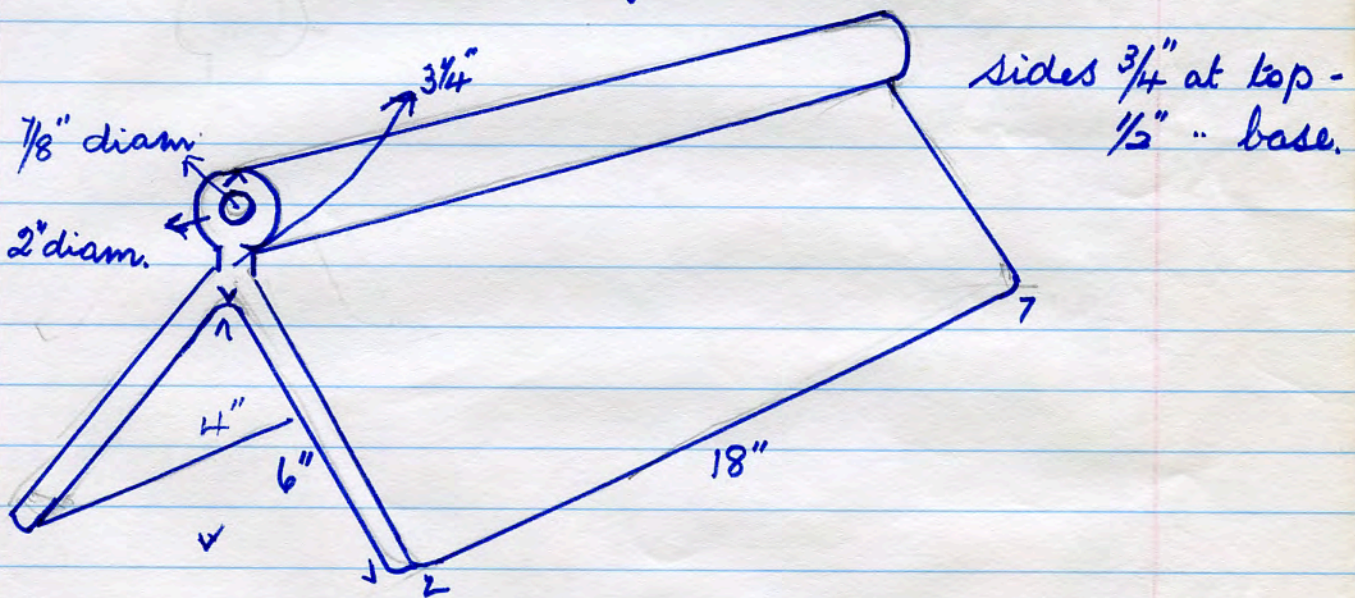

brankshaw's Howich. 11. 11. 80

no name. Red ridge tile. 45° pitch.
 stamped 90° inside.
 brankshaw's Howich 11. 11. 80

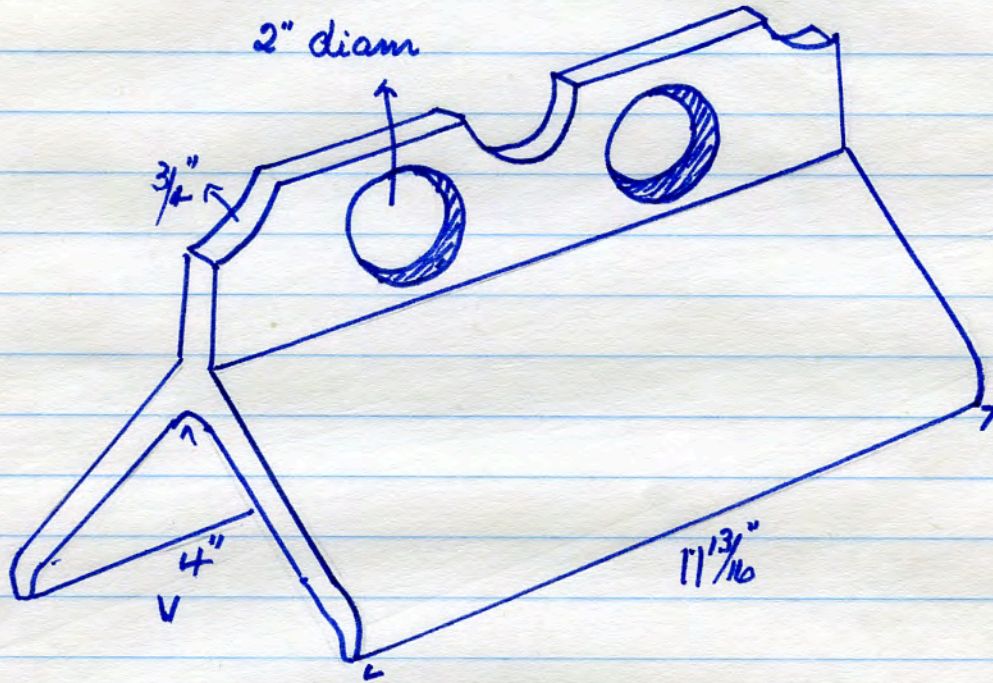

No name. 124 stamped. Red wall capping
 35 lbs. 11" x 12" x 5 1/2" return

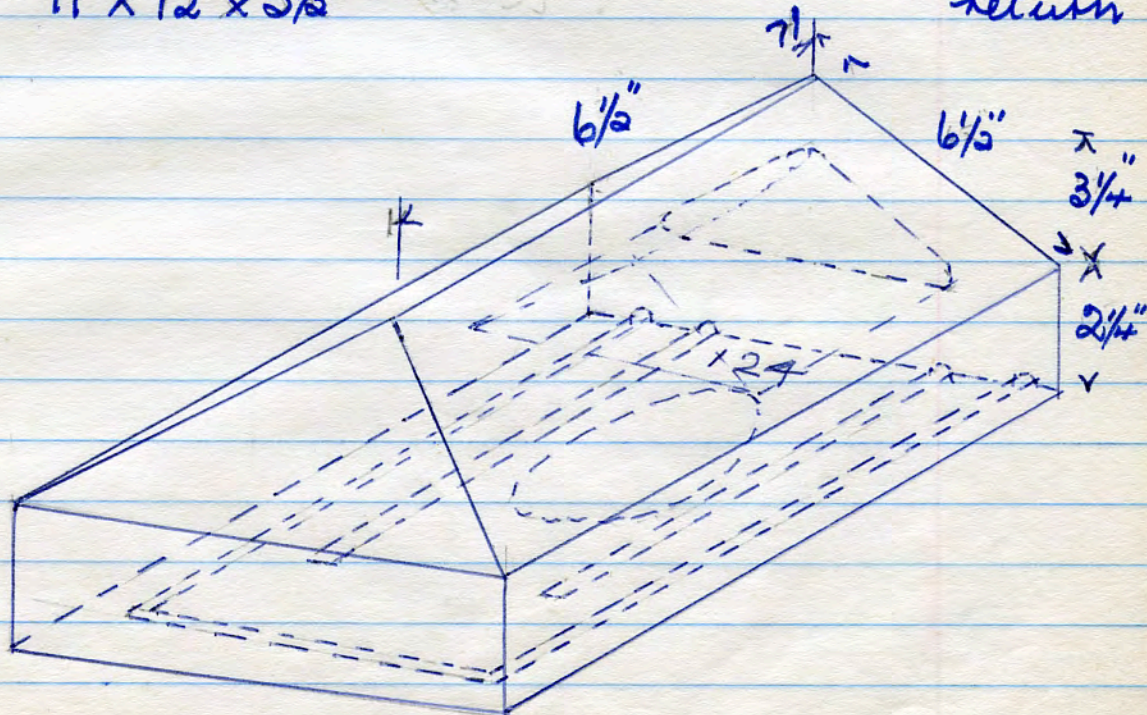

No name. blue wall capping return
 30 lbs. height 5 1/4"

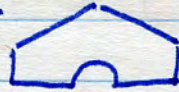

Old Police Station, near Gay St Mission, Willett St.
 Ballyhurst. Mfr 19. 10. 80

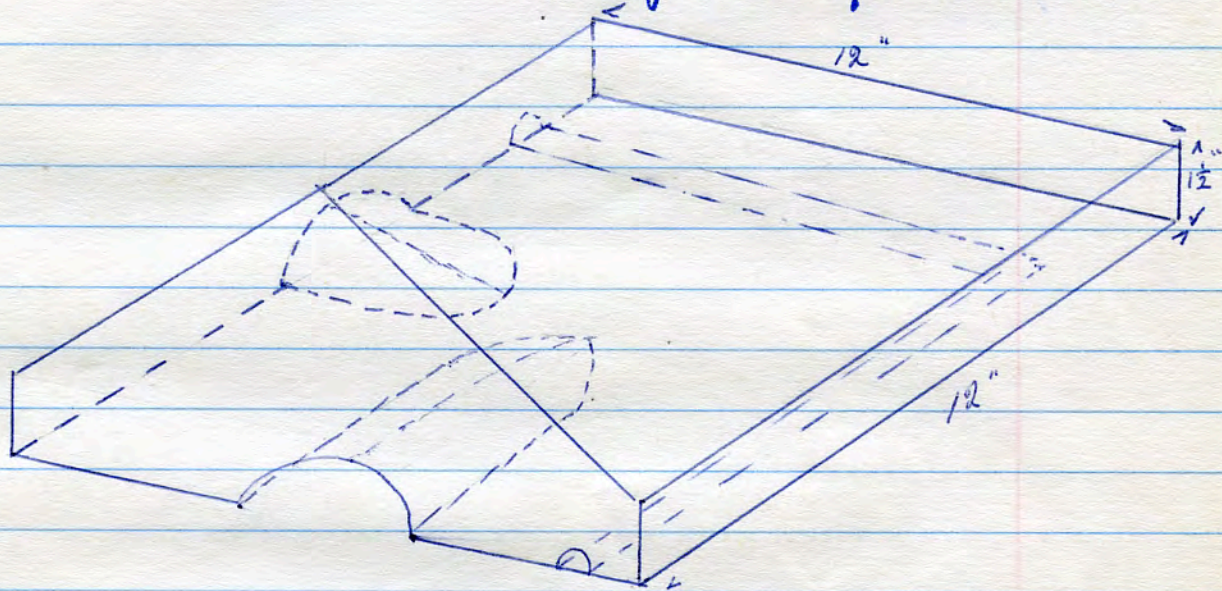

2376 x

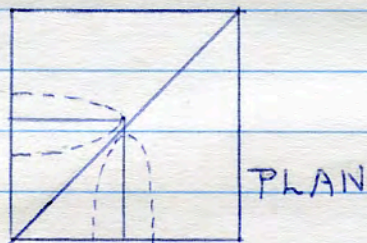

No name. Blue wall
 capping.
 50 lbs.

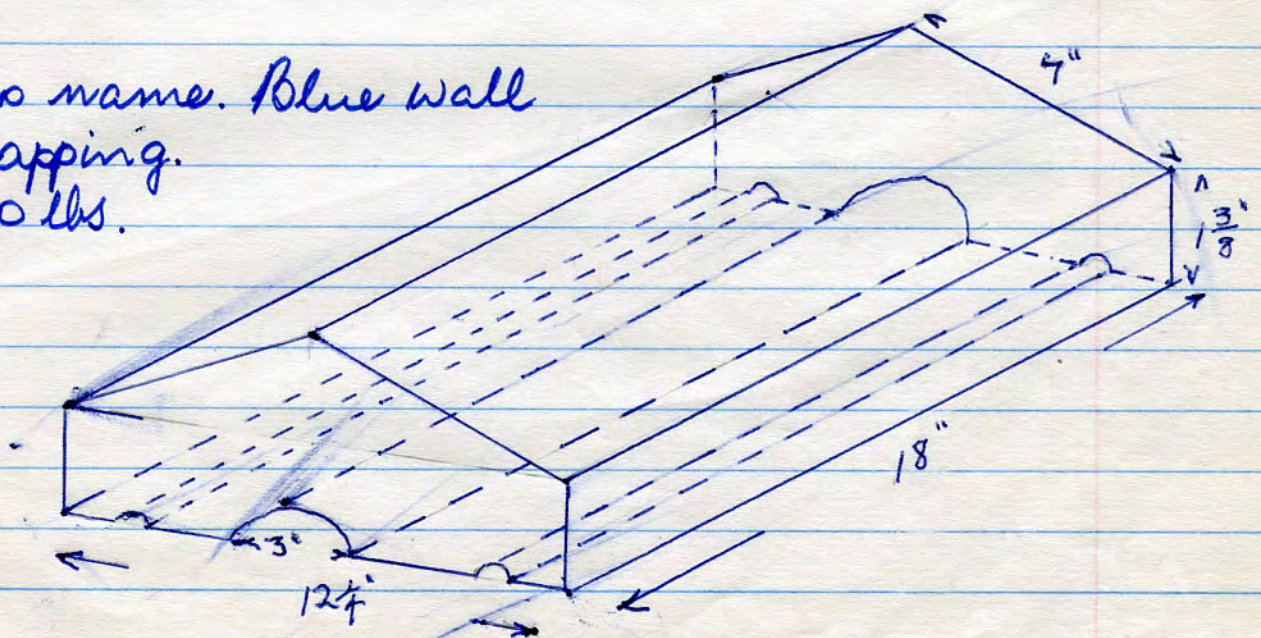

2377 x

Old Police Station, near Gay St. Mission, Willett St.
 Ballyhurst Mfr. 19. 10. 80.

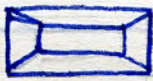

REVERSE SIDE
actual size

WADE & CHERRY'S PATENT
HORNSEA

2384.

1 3/4 lbs. red patent tile
Mrs Ros. 1. 2. 81.

A A

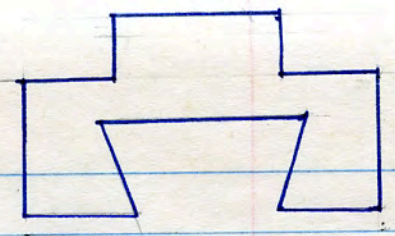

actual size.
section through A-A

OBVERSE SIDE

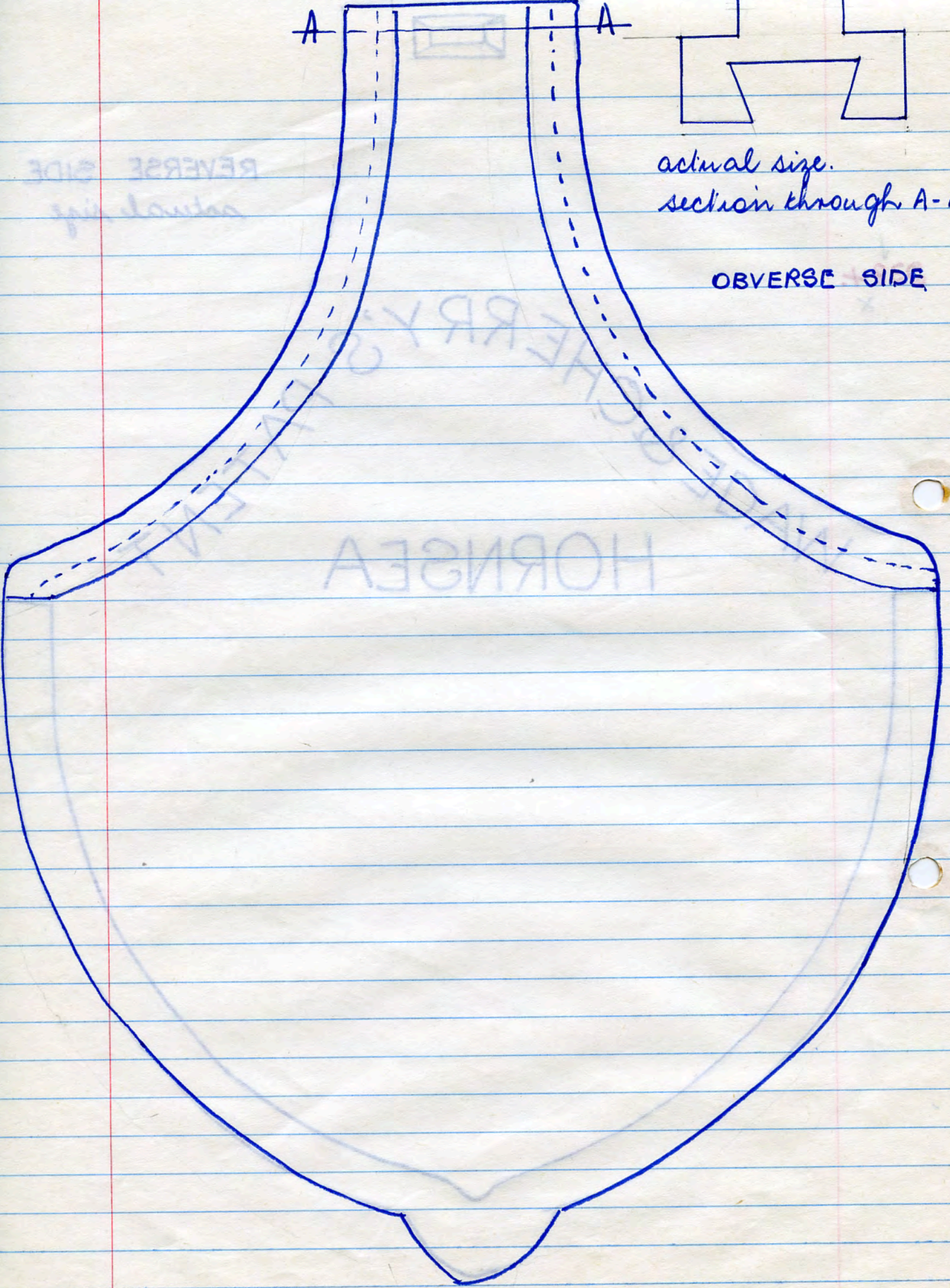

1/4" dia. x 1/8" thick
18 5 1 102 104

No name. Red wall capping.

12" x ~~14 1/2~~" x 6" x 18"

2403 x

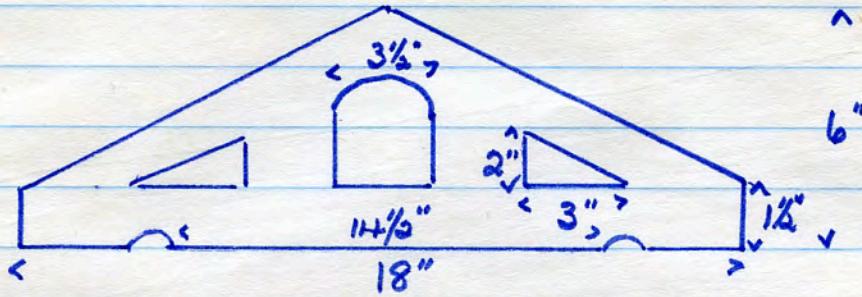

Canal St. off Oldham Rd. Rochdale. 8. 2. 81

Blue ridge tile - stamped TIMMIS. 60° pitch.
17 lbs.

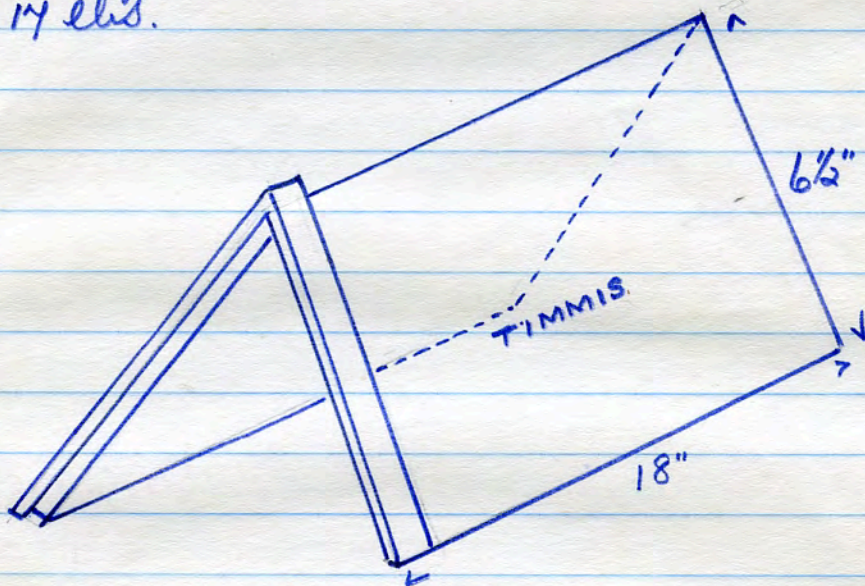

2404 x

Spare land. Taylor's Cowpe Garage. 24. 2. 81.

No name. dark red jamb brick.

8 lbs. 8 1/16" x 4 1/4" x 3"

*2407

single panel 1 side, plain rev.

Duckett's dem. Blannel St. Burnley

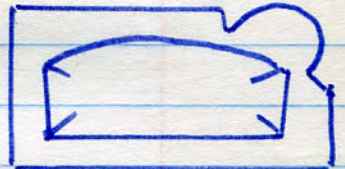

40 lbs.
21" high on a
12 1/2" square base.

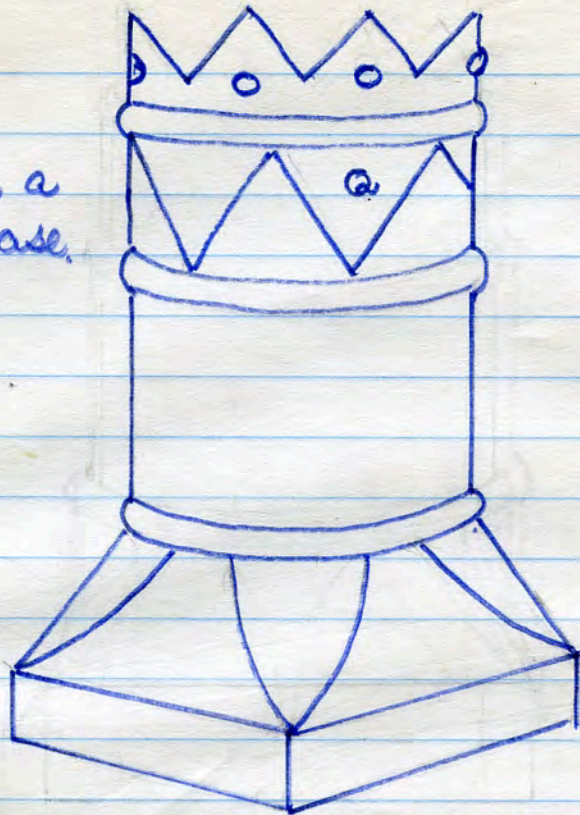

3 1/4"
3 3/4"
5"
6"
3"

2413

Q. salt glazed chimney pot, brown.
Cliff Street dem. Mitre, Burnley. 15. 2. 81.

No name. Head of pilaster



SIDE ELEVATION

REAR ELEVATION

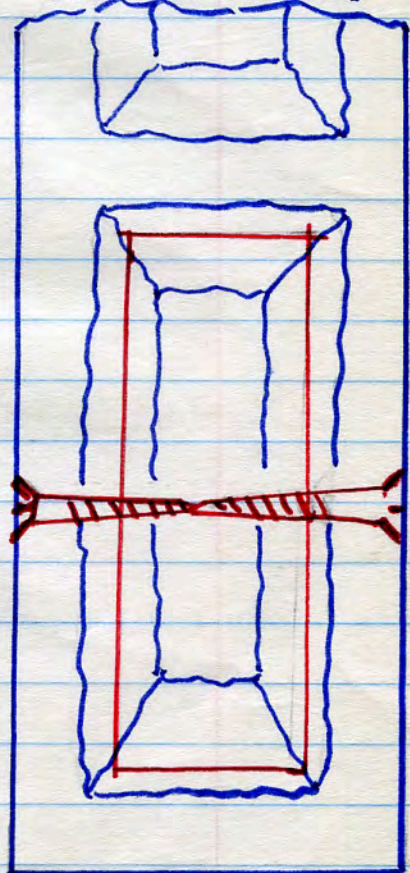

2424

12 1/2 lbs 6 3/4" x 11 1/2" x 5 1/2" Darby St. Farnworth 3. 8. 80.
Shouldered terra cotta with acanthus decoration in
relief on each side and front. Frog in rear
6 1/4" x 4" x 5 1/2" to hold fixing block (wood) marked in red.

J. ARMITAGE & SON. MANCHESTER & SHEFFIELD.

Stamped inside.

39 stamped on flat base.

2426
x

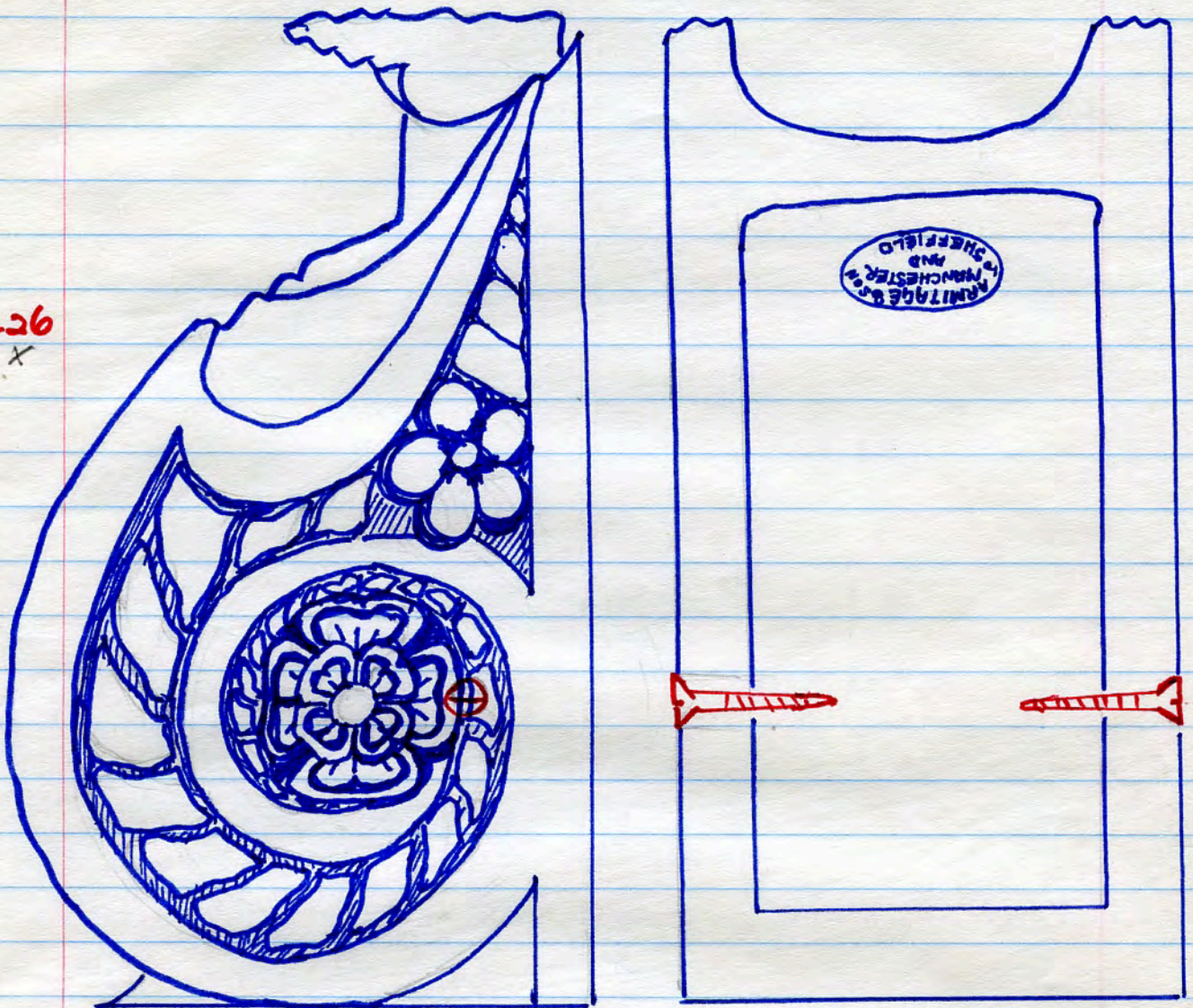

Head of pilaster. moulded fireclay with
rose & cable pattern. on each side. leaves &
bands on face. Knob in rear $6'' \times 9\frac{1}{2}'' \times 6''$
Fixing holes shown in red

21 lbs. $13'' \times 8'' \times 4''$

dem. blowes area. Salford.

C7 cornice. mitred return. no panels
10 1/2 lbs. 6 3/4" x 6 3/4" x 3 1/8"

Terra cotta. stamped on 1 edge
presumed J. C. EDWARDS.

2438

Long Millgate dem. m/k. 15. 3. 81.

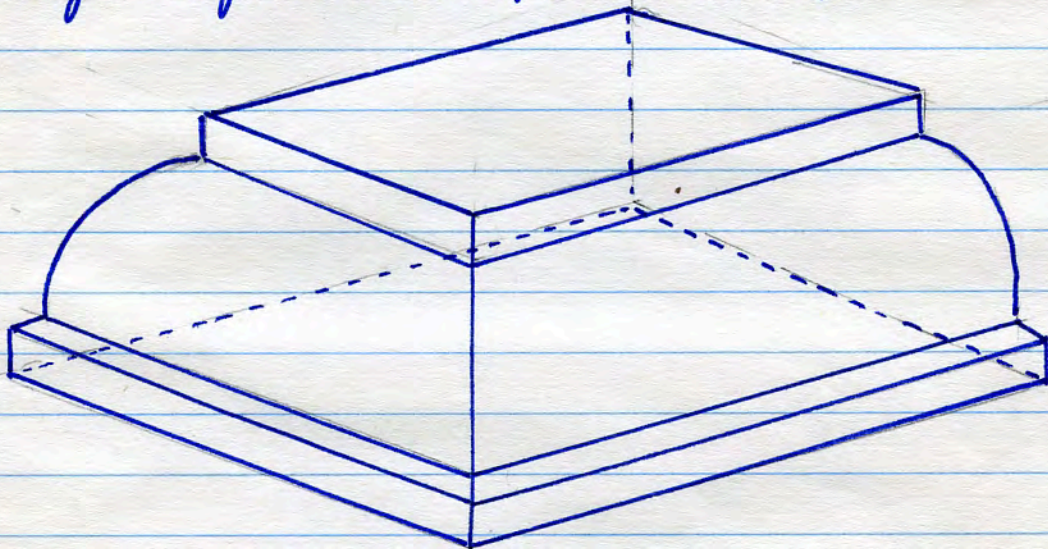

DENNIS RUABON dec terra cotta nail-head
8 lbs 9" x 4 3/8" x 3 1/8" stretcher.
single panel in base. 5/8" deep.

2439

letters incised clear.

Pilsworth Bleach Wks dem.

bastle Lane. Unsworth Bury.

15. 3. 81.

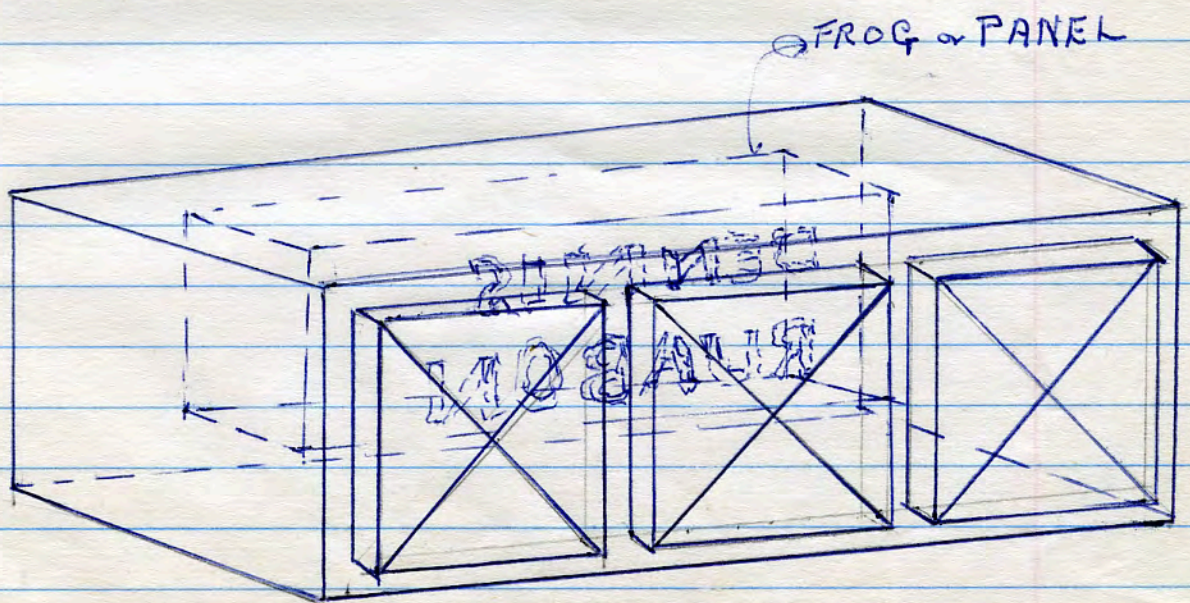

No name. Ventilator brick
salt glaze on fire clay.



4 lbs.
 $8\frac{3}{4}'' \times 2\frac{3}{4}'' \times 3''$

9 perfs straight thro.
Guide St. dem. Waste Mfr.

29. 3. 81.

2453+

IRON BROSELEY.
curved roof tile

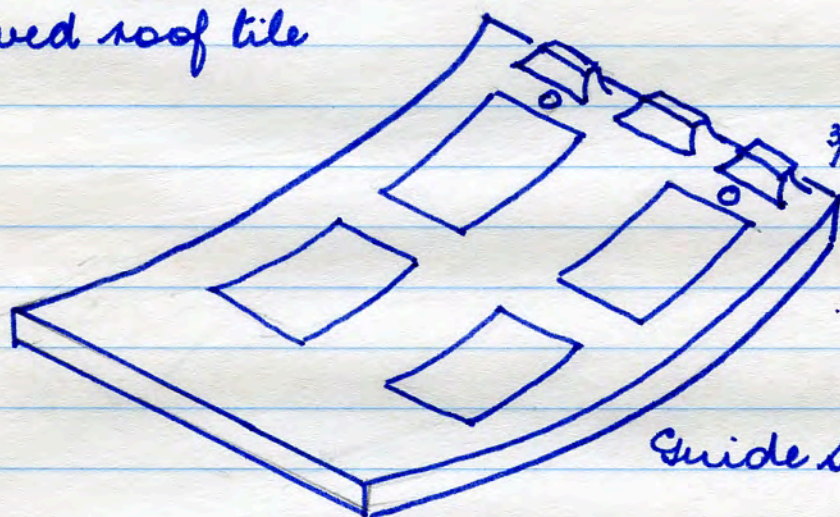

$\frac{3}{8}''$ projection $1\frac{1}{2}$ lbs.
 $10\frac{1}{4}'' \times 6\frac{1}{2}'' \times \frac{3}{8}''$

Guide St. dem. Waste Mfr.

29. 3. 81.

2454
x

$\frac{3}{8}''$

No name. floor paving tile - fire clay.

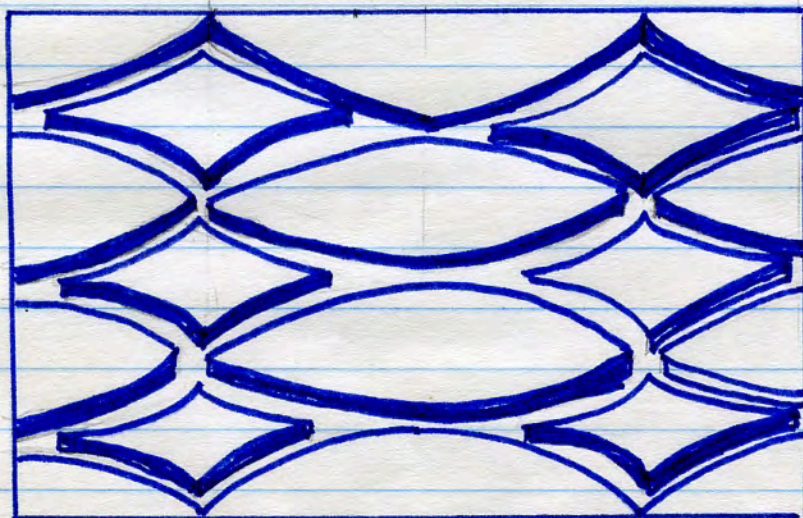

7 lbs.
 $10'' \times 4\frac{3}{4}'' \times 2\frac{1}{4}''$

2455.

Wanhill St. off North Hill St. Losbeth R/pool.

5. H. 81.

DAVIES BROTHERS ABENBURY BRICK WORKS WREXHAM
8 lbs. $9\frac{3}{8}" \times 4\frac{3}{8}" \times 3\frac{1}{8}"$

moulded header, terra cotta.

2456
x single panel 1 side only.
letters incised.

East Wynford St. Salford 29. 3. 81.



as above 2456. moulded stretcher, terra cotta.
14 lbs. $9" \times 6\frac{1}{4}" \times 3\frac{1}{8}"$

2457
x single panel 1 side only.
letters incised.

E. Wynford St. Salford
29. 3. 81.

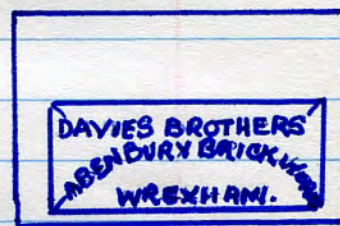
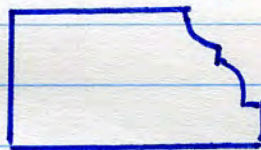

ROBINSON SHEFFIELD plinth stretchers
7 lbs. $9" \times 4\frac{1}{4}" \times 3"$

2458
x single panel, letters incised.

Guide St. Weaste M/r. 29. 3. 81.



RYDER (clay) nail head (3) stretchers.
7 lbs. $9\frac{1}{8}" \times 4\frac{3}{8}" \times 3\frac{3}{16}"$

2459
x

single panel rev. $6\frac{3}{4}" \times 1\frac{3}{8}" \times \frac{3}{4}"$ deep.

letters in relief.

East Wynford St. Salford M/r. 29. 3. 81.

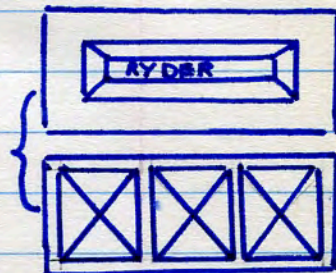

No name. decorative terra cotta corbel
7 lbs. $9\frac{3}{8}" \times 4" \times 3\frac{1}{2}"$

2464
x

no panels.

Guide St dem. Weaste M/r. 29. 3. 81.

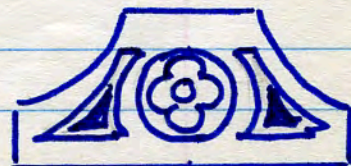

No name. decorative terra cotta gauged arch brick
 8 lbs. $8\frac{7}{8}'' \times 4'' \times 3'' - 2''$

2465 x

no panels
 Guide St dem. Waste M/4
 29. 3. 81.

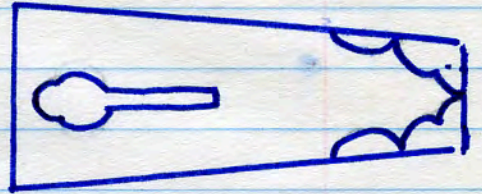

No name J 839 (J. L. Edwards).
 7 lbs. $9'' \times 4\frac{1}{4}'' \times 3\frac{1}{4}''$

2476 x

decorative terra cotta filler piece
 no panels. 1 perf $3\frac{1}{4}'' \times 1\frac{1}{4}''$
 David Lewis Home dem. L/pool. 5. 4. 81.

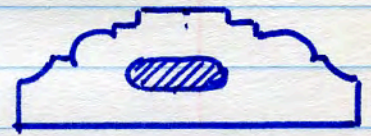

RUABON CO LTD N WALES RB & TC 37 5
 8 lbs. $9'' \times 9'' \times 1\frac{1}{4}''$ letters in relief red.

2444 x

	R	U	A	B	O	N		
	37					5		
			R B & T C					
		CO				LTD		
		N	W	A	L	E	S	

Jorklith
 L/pool
 5. 4. '81

2485 x No name, red, garden edge tile
 7 lbs. 9" x 9" x 1" with 2" diam rope pattern
 David Lewis Hostel dem. site. L/pool. 12. 4. 81.

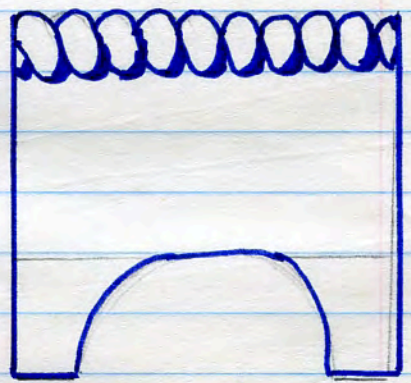

2486 x No name, decorative terra cotta (clay) corbel.
 7 lbs 8 7/8" x 3 3/16" x 3"
 no panels
 David Lewis Hostel dem. site. L/pool. 12. 4. 81.

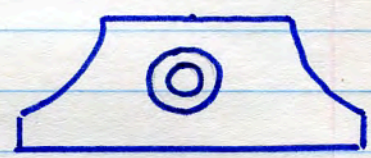

2487 x SKIERS SPRING HOYLAND.
 nail head stretchers.
 9 lbs. 9" x 4 3/4" x 3"
 name stamped 1 side.
 David Lewis Hostel dem. site. L/pool. 12. 4. 81.

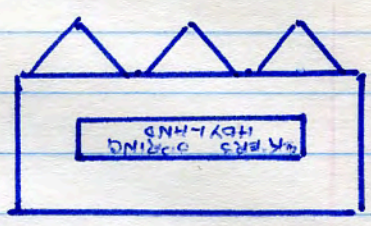

2488 x HAN
 - COCK & CO HAW
 --- ARDEN
 part blue paver. 5 lbs. 5" x 2"
 Maltese cross pattern in relief
 Sutton Rd dem site, St Helens
 letters incised on rev.

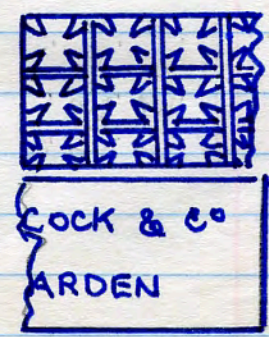

J 820 No name (Ruabon B + YC. - J.C.E.)

Terra cotta dec. jamb brick.

12 lbs. $10\frac{1}{2}'' \times 5\frac{13}{16}'' \times 3\frac{5}{16}''$

David Lewis Hostel dem. site. 12. 4. 81.

2490
x

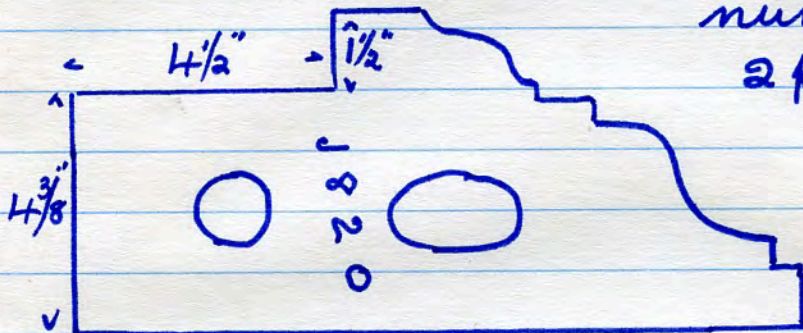

numbers stamped
2 perfs $1\frac{5}{8}''$ diam.
 $2\frac{1}{4}'' \times 1\frac{3}{4}''$

No name, terra cotta ventilator

7 lbs. $9'' \times 6\frac{1}{4}'' \times 3\frac{1}{8}''$

2492 David Lewis Hostel dem. site. 12. 4. 81.

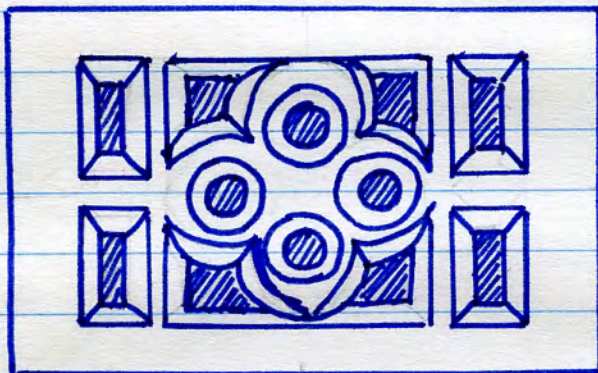

No name. Terra cotta. piece of tracery (window).

11 lbs. $9\frac{5}{8}'' \times 5'' \times 4\frac{5}{8}''$

David Lewis Hostel dem. site. 12. 4. 81.

2493
x

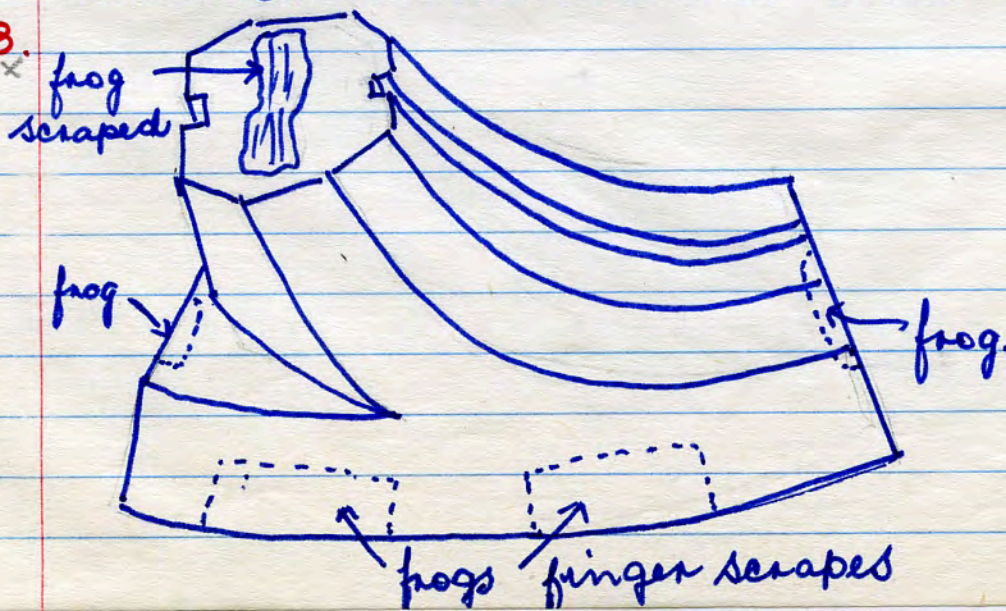

W. J. red floor tile
3 lbs $6\frac{1}{8}" \times 6\frac{1}{8}" \times 1"$

2494^x

3 shallow panels rev. letters incised
Alexandra Dock Rwy dem. L/pool.
19. 4. 81

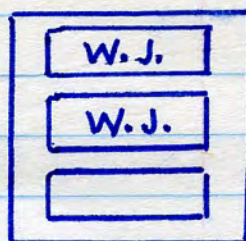

No name. dec. terra cotta conch.
8 lbs. $8\frac{3}{4}" \times 4\frac{1}{4}" \times 3"$

2507^x

single panel in rear with finger marks.
5 pointed star dec.
David Lewis Hostel dem. L/pool. 19. 4. 81.



No name, dec. stretcher, red.
10 lbs. $8\frac{7}{8}" \times 3\frac{3}{4}" \times 3\frac{3}{8}"$

2508^x

no panels, 3 leaf decoration.
Alexandra Dock Rwy dem. L/pool. 19. 4. 81.



No name, blue ventilator
5 lbs. $8\frac{7}{8}" \times 2\frac{5}{8}" \times 3\frac{1}{4}"$

2509^x

Guinshill St. Fosseth, L/pool. 19. 4. 81.



REDLAND GROVEBURY roof tile, red. (part)
7 lbs. $16\frac{1}{2}" \times 6\frac{1}{2}"$ (broken) $\times \frac{1}{2}"$ thick.
letters incised.

2510^x

Lyster Road (near
Alexandra Dock,
L/pool. 19. 4. 81.



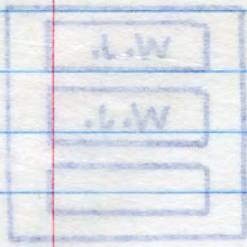

W. L. red floor tile
 3 1/2" x 1" x 1/2" x 1/2"
 3 shallow panels see letters inside
 19. 11. 81

2144

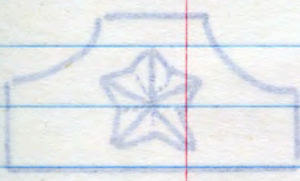

Mr name see letters inside
 3 1/2" x 1 1/2" x 3/4"

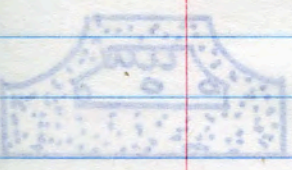

And panel in seen with finger marks
 2 pointed stars
 18. 11. 81

2201



Mr name see letters inside
 10 lbs 8 1/8" x 2 1/4" x 3/8"

2202



Mr name blue ventilator
 2 lbs 8 1/8" x 2 1/8" x 3/4"

2203

REDLAND GROVEBURY roof tile red (part)
 7 lbs 1 1/2" x 1 1/2" (square) x 1/2" thick
 letters inside

2210

TOP VIEW. SETTING OUT MARKS BURNT IN

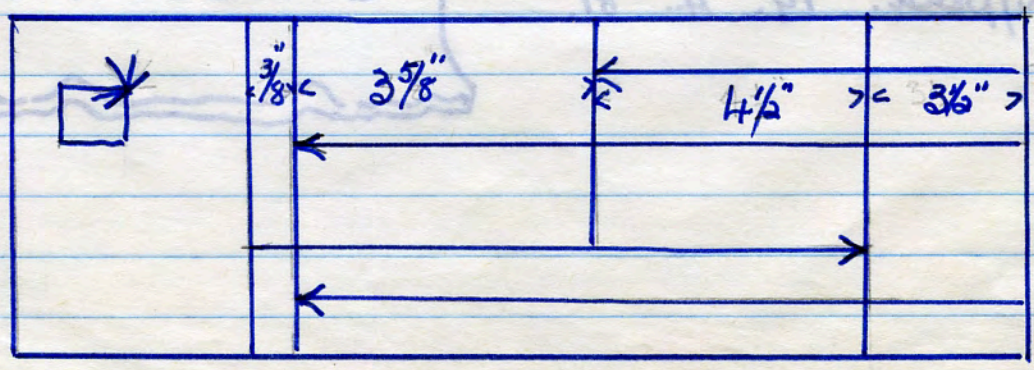

Q 12 □ terra cotta moulded stretcher. (Ruabon)
33 lbs 8" x 13 1/2" x 6 5/8"

2 hand scraped holes in rev. approx. 4" x 5 1/4"
4" x 4 3/4"

2512
x

2 O holes in ends. 2 1/2" in panel 5" x 3 3/4"

Alexandra Dock Rlwy dem. L/pool. 19. 4. 81.

END VIEW

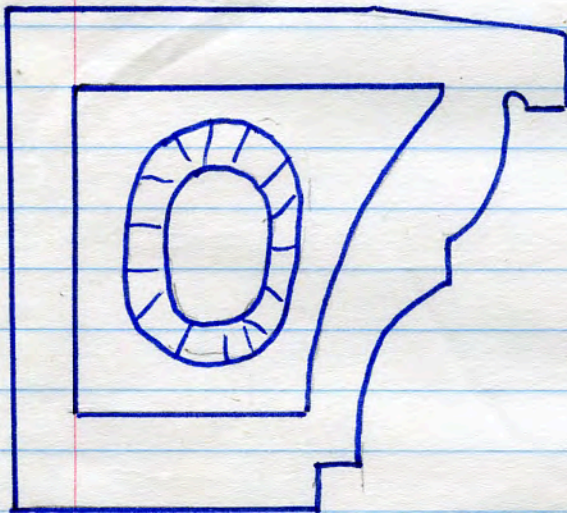

REAR VIEW

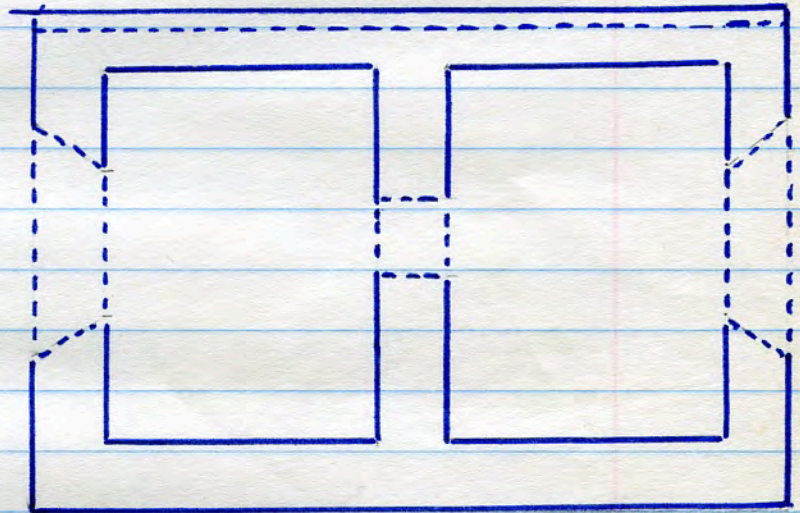

Q 14 □ terra cotta moulded stretcher with
35 lbs. 8" x 15 1/2" x 6 5/8" return
moulded section as above 2512.

Alexandra Dock Rlwy dem. L/pool. 19. 4. 81.

2513
x

FRONT VIEW

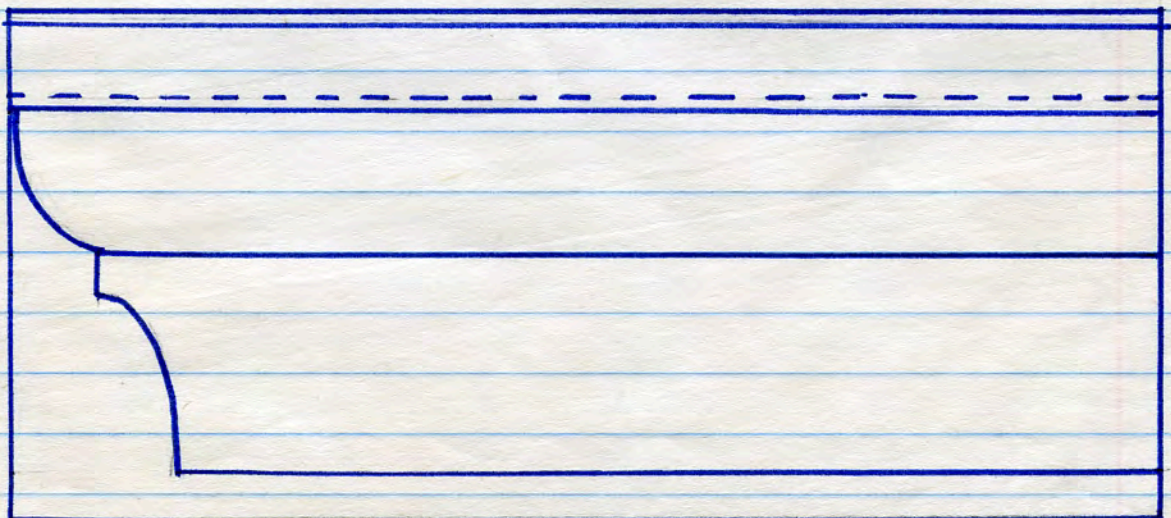

FRONT VIEW

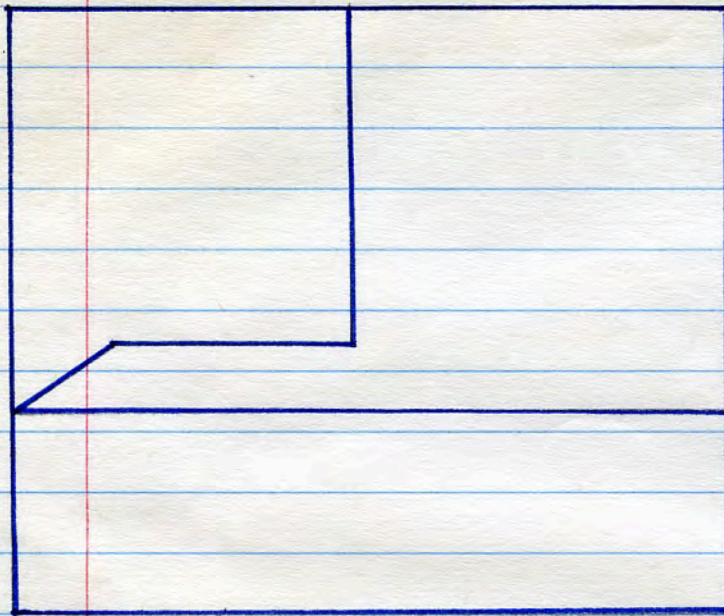

END VIEW

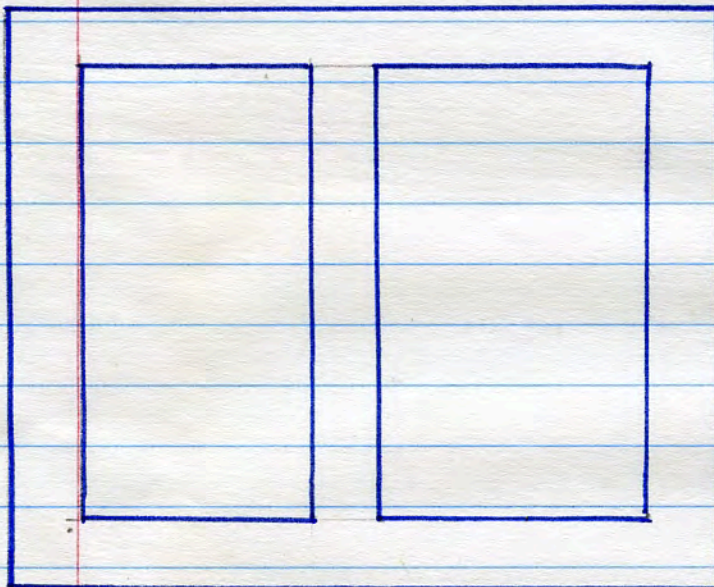
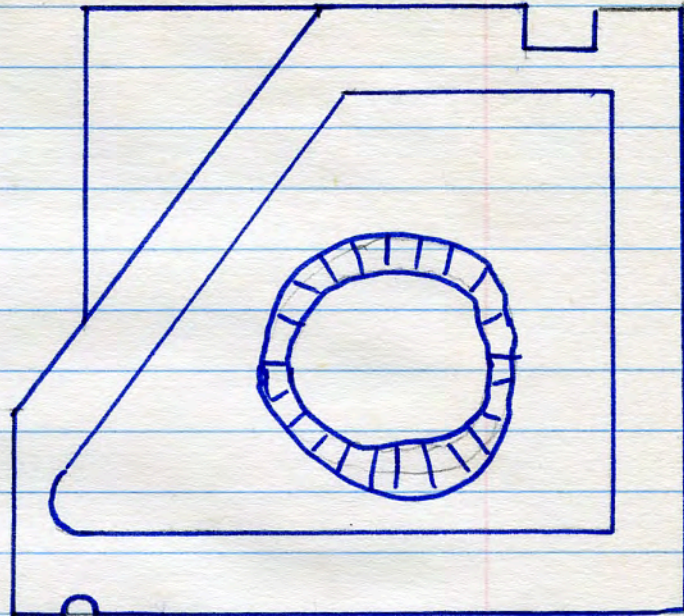

REAR VIEW

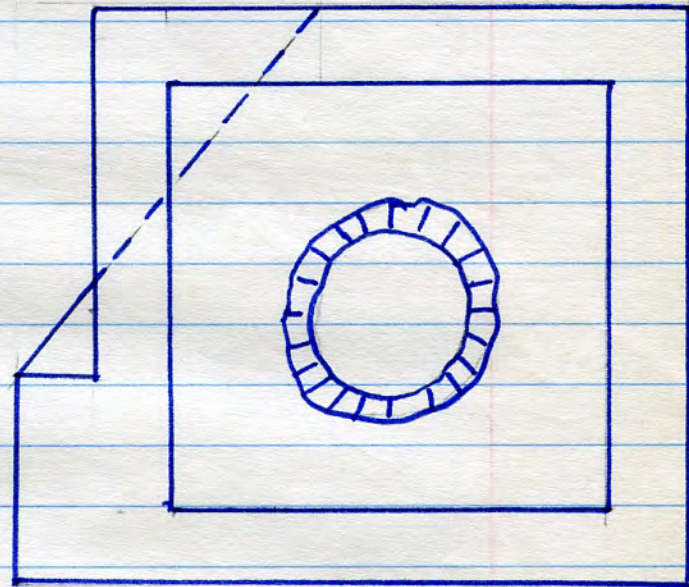

END VIEW

J P 1 window sill with stooling, terra cotta
 34 lbs. $10\frac{3}{8}'' \times 6\frac{3}{8}'' \times 9\frac{1}{8}''$ (Ruabon)
 2 hand scraped holes in rev. - $4'' \times 3''$ approx.
 2 O holes in ends - $2\frac{1}{4}''$ diam. in panel
 Alexandra Dock Plwy. dem. h/pool. 19. 4. 81

2514

J 812 moulded terra cotta stretcher or jamb.
18 lbs. 10" x 6 1/4" x 5 7/8"

2 hand scraped holes in rev. 3 1/2" x 3 1/2" single shallow panel in each end.

David Lewis Hostel dem. L/pool 12. 4. 81

The two holes to act as frogs - for filling with ballast.

FROGS
for filling with
Ballast

2515 x

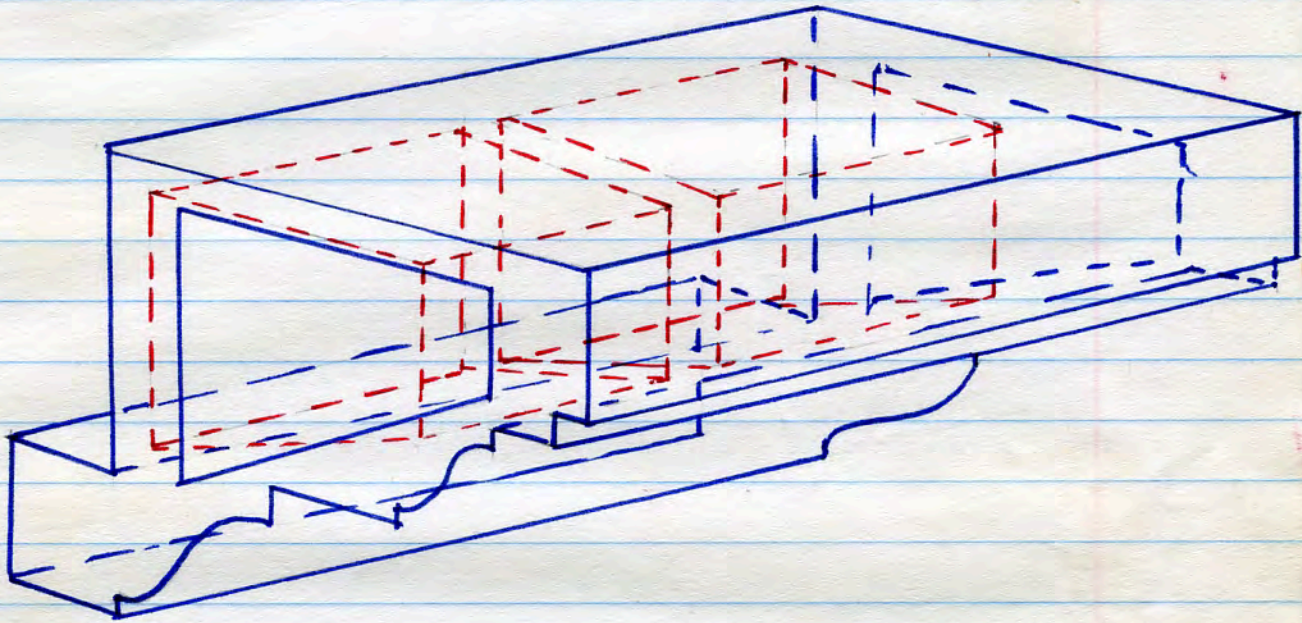

J 219 moulded terra-cotta door jamb.

45 lbs.

similar specs;
to 2515 above.

2516 x

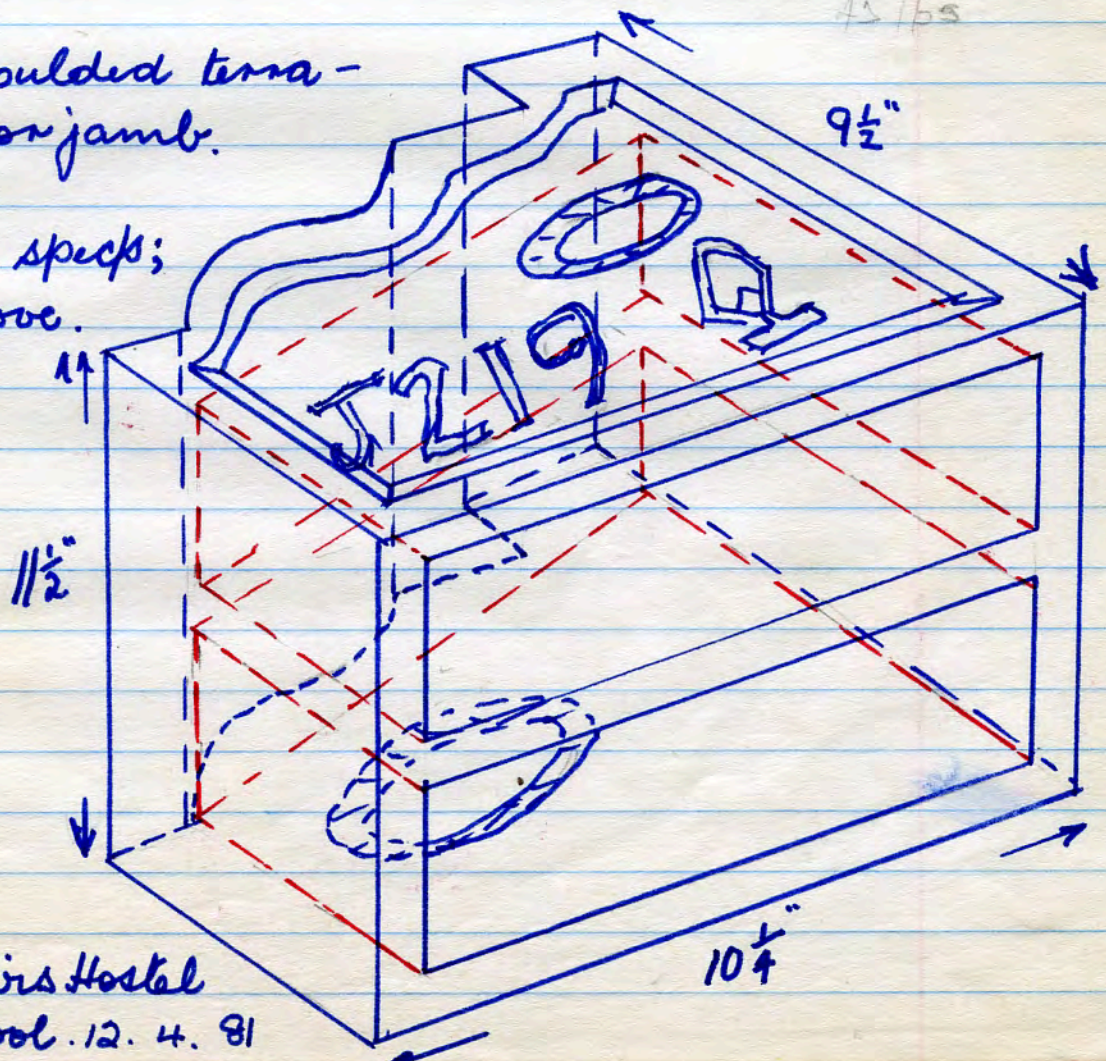

David Lewis Hostel
dem. L/pool 12. 4. 81

2517.

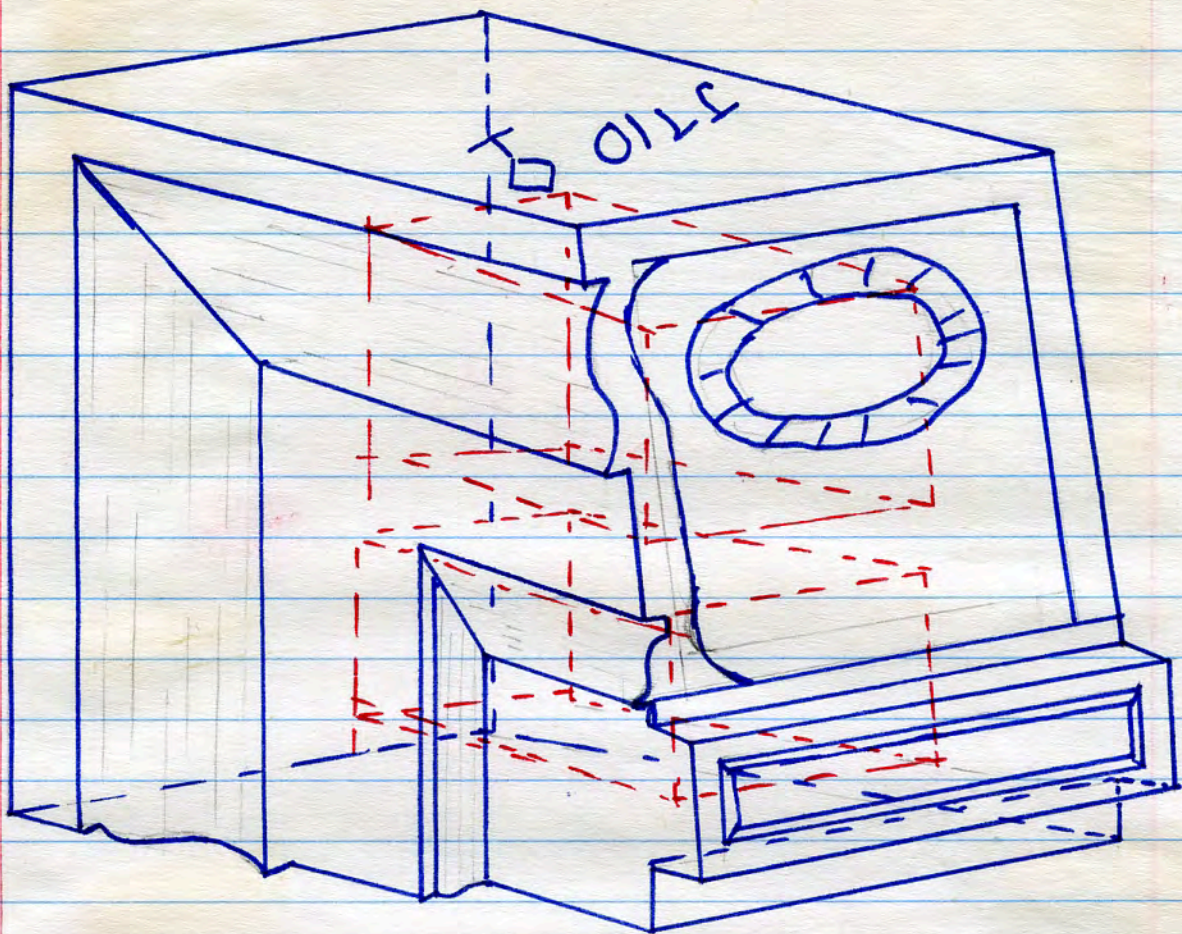

J 710 moulded terra cotta, showing where
48 lbs. $12'' \times 9\frac{3}{4}'' \times 10''$

horizontal & vertical mouldings meet in a mitre,
showing angle & lip where next appropriate
piece will join.

2 hand scraped holes - to act as frogs, for
filling with ballast, 8" deep.

$6'' \times 3''$ with brick ballast retained.

$4\frac{1}{4}'' \times 3\frac{1}{2}''$ " " " removed.

letters scribed on 1 side.

circular holes, 1 in each panel of adjacent
fixing faces. $3'' \times 2\frac{1}{2}'' + 3\frac{1}{2}'' \times 2\frac{3}{4}''$

David Lewis Hostel dem. L./pool 19. 4. 81.



No name. - grate in fired clay
28 lbs. $11\frac{3}{4}'' \times 11\frac{3}{4}'' \times 4\frac{1}{2}''$

grate size $6\frac{1}{2}'' \times 6\frac{1}{2}'' \times \frac{3}{4}''$. Oescit 6" diam $\times 1\frac{1}{2}''$
Z. Temperley's (middle shop) 2. 4. 81.



2526*

J 190 abacus - terra cotta
David Lewis Hostel dem. L./pool. 19. 4. 81

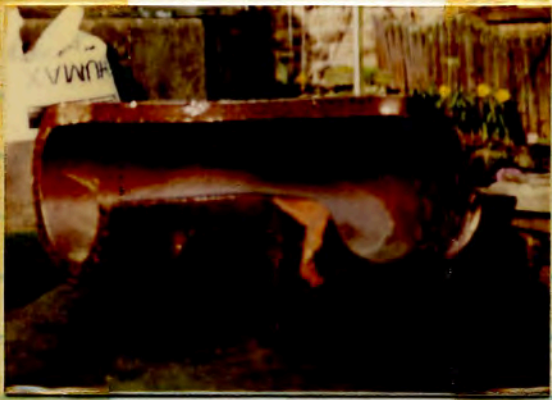

(FTS) stamped
 250 scratch stamp
 2 in hammer "

10" in. curve
 12" external curve
 to connect 2 x 4" diam

pipes, as an inspection bend.

7 lbs. 1/2" thick salt glazed fine clay.
 7. Temperley's (Middle Shop) dem. 3. 4. 81.

2522



No name.
 Inspection case for
 3 way joint in
 salt glazed fine clay.
 32 lbs (21 lbs + 11 lbs)
 23 1/2" long over all
 16 1/2" front to back.
 3 1/2" diam outlets.
 3 1/4" diam hole in lid.
 7. Temperley's dem.
 Dulesgate. 2. 4. 81.

2528



No name. Ventilated ridge
 tile in salt glazed fine clay.
 23 lbs
 7 Temperley's dem. 2. 4. 81

2529

Stopper - salt glazed fine clay.
 2 lbs
 7. Temperley's dem. Dulesgate

2531

2. 4. 81

2536
x

E. PARRY BUCKLEY blue paving.
9 lbs. 11" x 5⁵/₁₆" x 2"
single shallow panel rev.
letters incised.
Mersey St. Warrington. 24. 5. 81

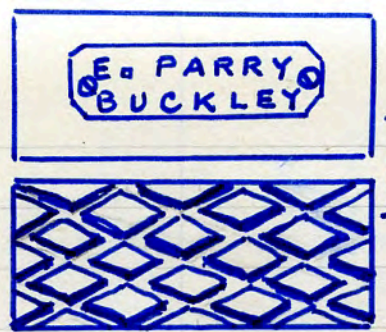

2537
x

EDWARD BARNETT WALSALL WOOD blue paving.
8 lbs. 10³/₄" x 5¹/₄" x 2"
shallow oval panel stamped rev.
Mersey St. Warrington 24. 5. 81



2538
x

SKIERS SPRING HOYLAND red floor tile
10 lbs. 9¹/₂" x 9¹/₂" x 1³/₄"
plain obv. 5 panels reverse.
name stamped.
Blackstone St Goods Yard dem
L/Pool. 24. 5. 81



2540
x

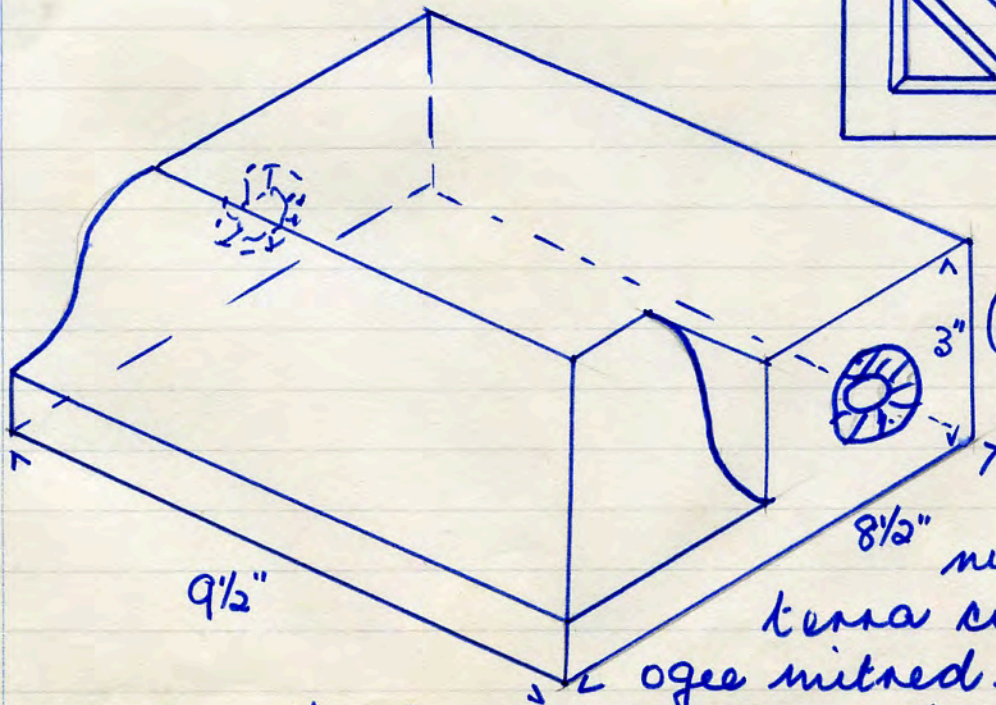

J 944
(J. L. Edwards).

16 lbs.

numbers stamped
tenna cotta.

ogee mitred return
Langton Warehouse, Office dem. Waterloo Rd
L/Pool. 19. 4. 81

2547 x No name, blue channel brick
14 lbs. $11\frac{3}{4}" \times 5\frac{7}{8}" \times 3"$
Arthur St tip, Garston. L./pool.
24. 5. 81

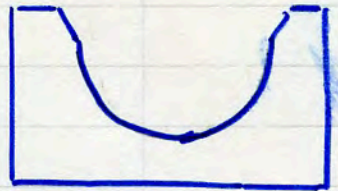

2548 x A H 5 6 X X terra cotta stretcher plinth,
7 lbs. $8\frac{1}{8}" \times 4\frac{3}{8}" \times 3\frac{1}{8}"$
letters punched on ✓
Lyster Rd. L./pool. 24. 5. 81

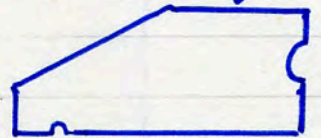

2567 x No name, dec. clay header.
7 1/2 lbs. $9\frac{1}{4}" \times 4\frac{3}{8}" \times 3\frac{1}{4}"$
single panel each side
Hardman St. dem. Busby 14. 5. 81

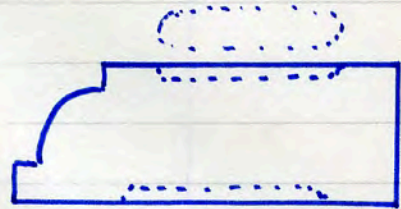

2568 x No name, red paver.
8 lbs $9\frac{3}{8}" \times 5\frac{1}{16}" \times 4\frac{5}{8}"$
single panel rev.
made of good clay mixture.
Aron St. mill dem. 14. 5. 81



2569 x No name, dec. terra cotta stretchers.
8 lbs. $8\frac{7}{8}" \times 3\frac{5}{8}" \times 2\frac{7}{8}"$
no panels, flowers in relief.
Vernon St. dem area, Bolton 14. 5. 81



2584 x VITROS blue paver
8 1/2 lbs. $9" \times 4\frac{1}{2}" \times 3"$
single panel obv. letters in relief
six raised chamfered studs obv.
Belle Green tip. Kirkstrees, Wigan 21. 6. 81.

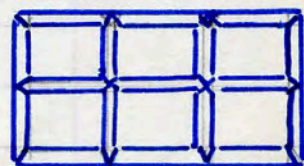
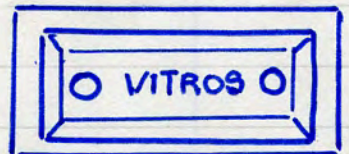

WITHNELL BRICK TERRA COTTA CO LTD
1 lb PLASTIC 1 lb red plinth (1912 in rev)
7 lbs. $8\frac{5}{8}$ " x 4" x $2\frac{1}{8}$ "

2585
x

single panel rev. letters incised.
groove on panel edge rev.

Belle Green tip, Kirkcubley, Wigan 21. 6. 81

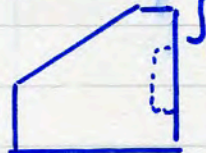
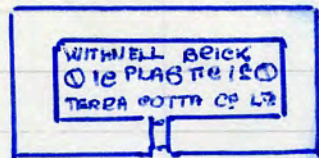

WITHNELL BRICK TERRA COTTA CO LTD 1912.
red, moulded sill piece.

14 lbs. $8\frac{7}{8}$ " x $6\frac{1}{2}$ " x 3"

2586
x

single panel rev. with groove.
letters incised

Belle Green tip, Kirkcubley, Wigan. 21. 6. 81.



No name, red moulded sill

12 lbs. 9" x $6\frac{3}{16}$ " x 3. wire run.

2587
x

no panels. 1 perf $1\frac{1}{2}$ " x 1" through.
Weymouth St dem. Bolton. 31. 5. 81.



MONK & NEWELL RUABON plinth, red
7 1/2 lbs $8\frac{7}{8}$ " x $4\frac{5}{16}$ " x 3" R on end
single panel rev. letters incised
Sidney St Leigh (near Brook Hill) 7. 6. 81.

2588
x

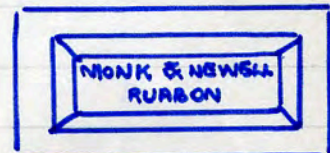

L N W red, chamfered leader
9 lbs $8\frac{3}{4}$ " x $4\frac{1}{4}$ " x 3"

2589
x

single deep, ^{scooped} panel rev. letters stamped
to exchange R/wy Station dem 14. 6. 81.
Manchester.

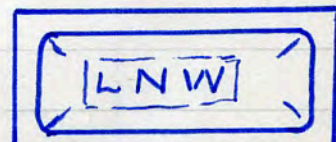

2590
x

L N W red chamfered stop end.
as 2589.

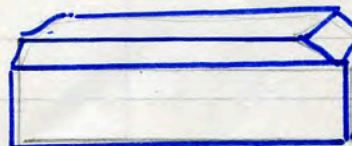

2591_x

No name. red. egg & tongue stretcher.
7 lbs. $8\frac{3}{4}'' \times 3\frac{7}{8}'' \times 3''$.

single panel $\frac{1}{2}''$ deep in rev.
Guest St dem. Leigh. 7. 6. 81.



2592_x

No name. floral stretcher, red.
7 lbs $8\frac{3}{4}'' \times 3\frac{5}{8}'' \times 3''$

single panel in rev.
Guest St dem. Leigh. 7. 6. 81.



2593_x

No name (Duckett?) corbel.
12 lbs $12'' \times 5\frac{3}{4}'' \times 2\frac{7}{8}''$

no panels.
Rose Grove Goods Station W/house. 16. 6. 81.

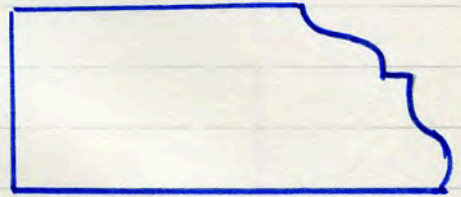

2618_x

S N blue paper.
8 lbs. $9'' \times 4\frac{3}{8}'' \times 2\frac{1}{2}''$

double panel rev. letters in relief
8 raised chamfered studs obs.
S. Spencer. Police Stables, Harrow.

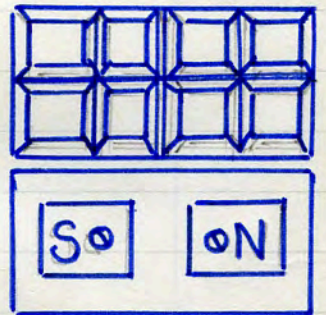

2619_x

No name. red stretcher sill piece (Fletcher Bolton)
. 9 lbs $8\frac{3}{4}'' \times 4\frac{3}{8}'' \times 2\frac{3}{4}''$

single panel + drip bar on rev.
Thos Walker's Rose Hill Tannery dem.
(Bolton) Great Lever. 19. 7. 81.

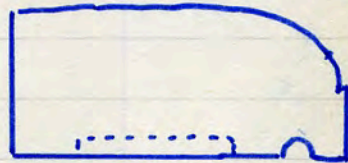

2628_x

FLETCHER red decorative header.
9 lbs. $8\frac{3}{4}'' \times 11\frac{3}{16}'' \times 2\frac{5}{16}''$

single panel 1 side, plain rev.
letters in relief.
Bridgeman St. dem
Great Lever. 19. 7. 81.

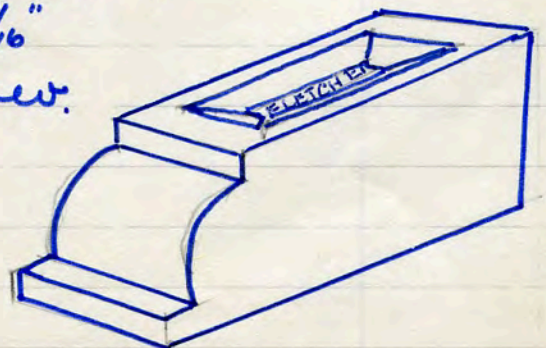

Red terra cotta wall capping
 30 lbs
 No name

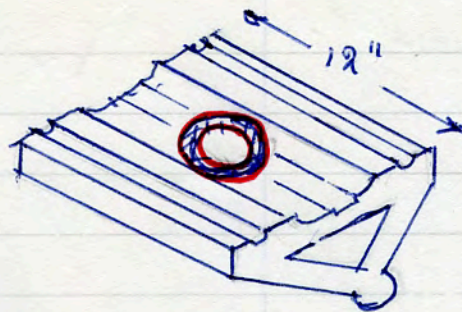

2595 x

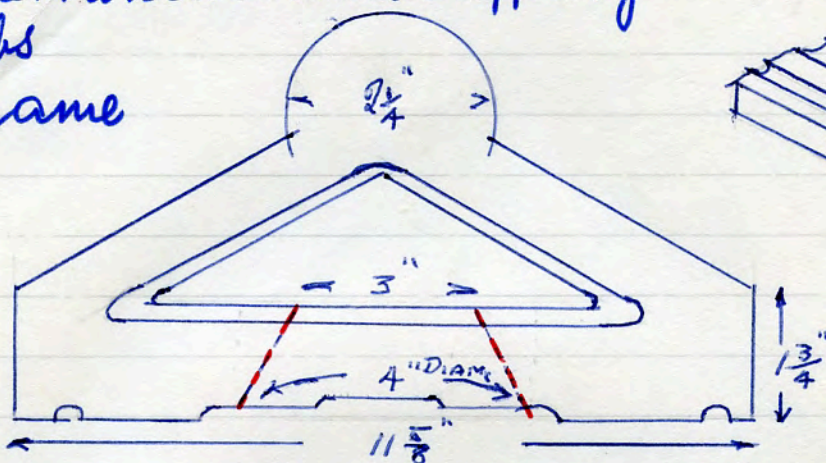

Wall capping < 2" > Red terra cotta
 42 lbs No name.
 12" long.

2596 x

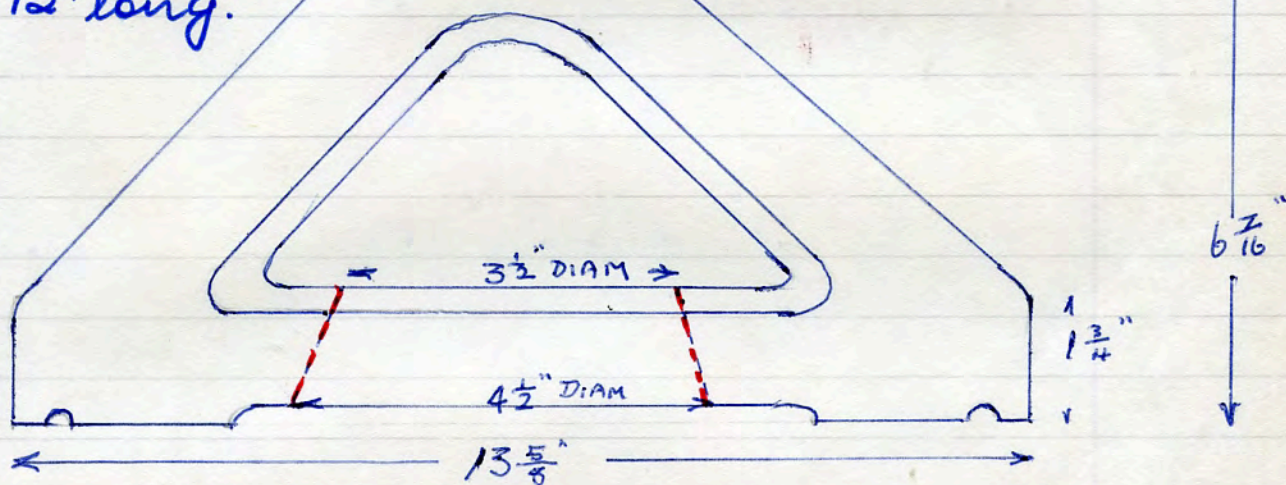

Wall capping. Red terra cotta.
 39 lbs No name.
 12" long

2597 x

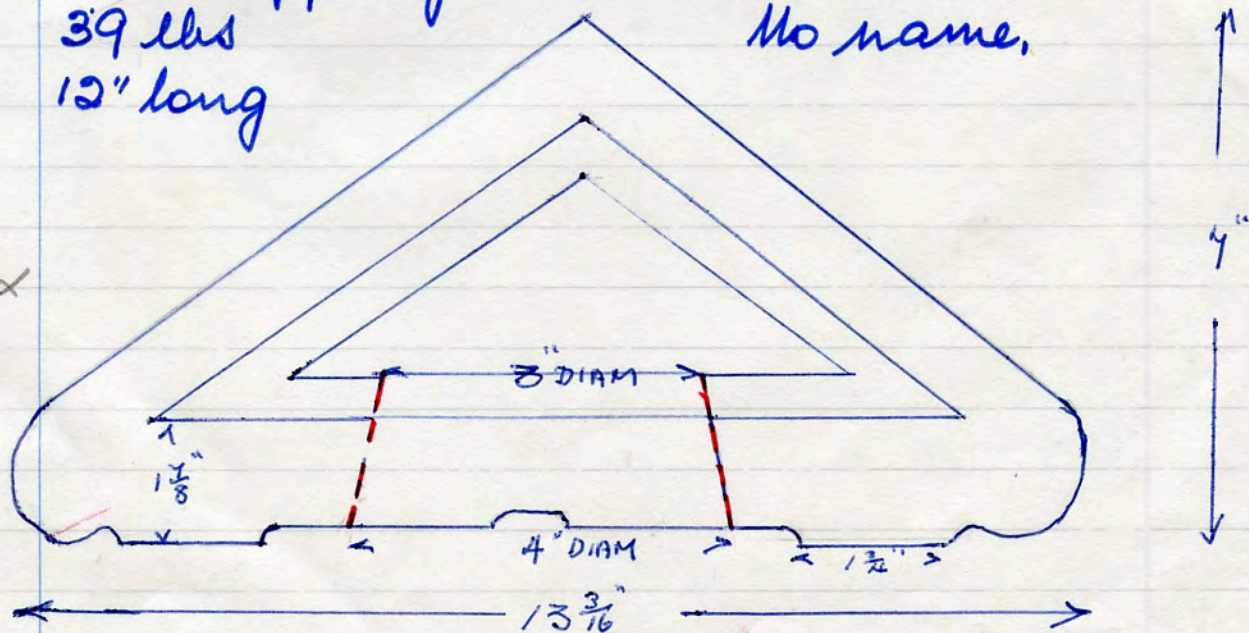

All above from perimeter of Enfield B + F Co. Co Ltd
 Clayton. Le. Moor 17. 6. 81

Wall capping.
 18 1/8" long
 38 lbs.

Brown salt glazed.

2598 x

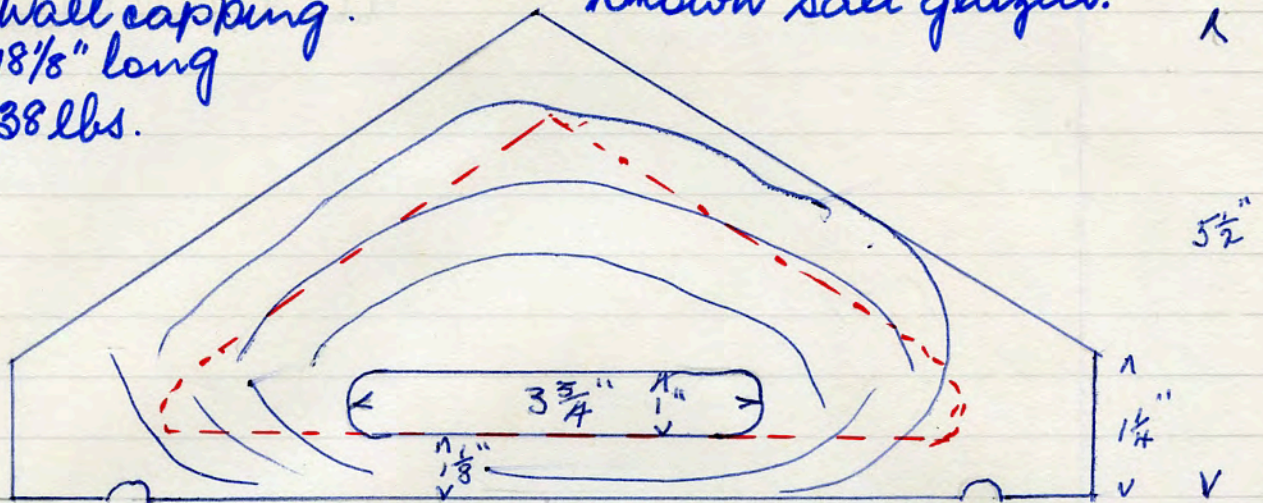

Bolton. off St George's Rd. 21. 6. 81

Brown salt glazed. 12" x 12" x 1 3/4" 12 lbs
 Obv. 8 small perfs 15/16" dia x 1/16" in each of 15/16" diam holes
 in Rev - 10 x 11 perfs 15/16" diam x 1 5/16" deep.

Flies tile for grain drying
 Stanley Bros. Munceton. (PATENT)
 Mr. N. Taylor. Chadderton. 8. 7. 81.

2600 x

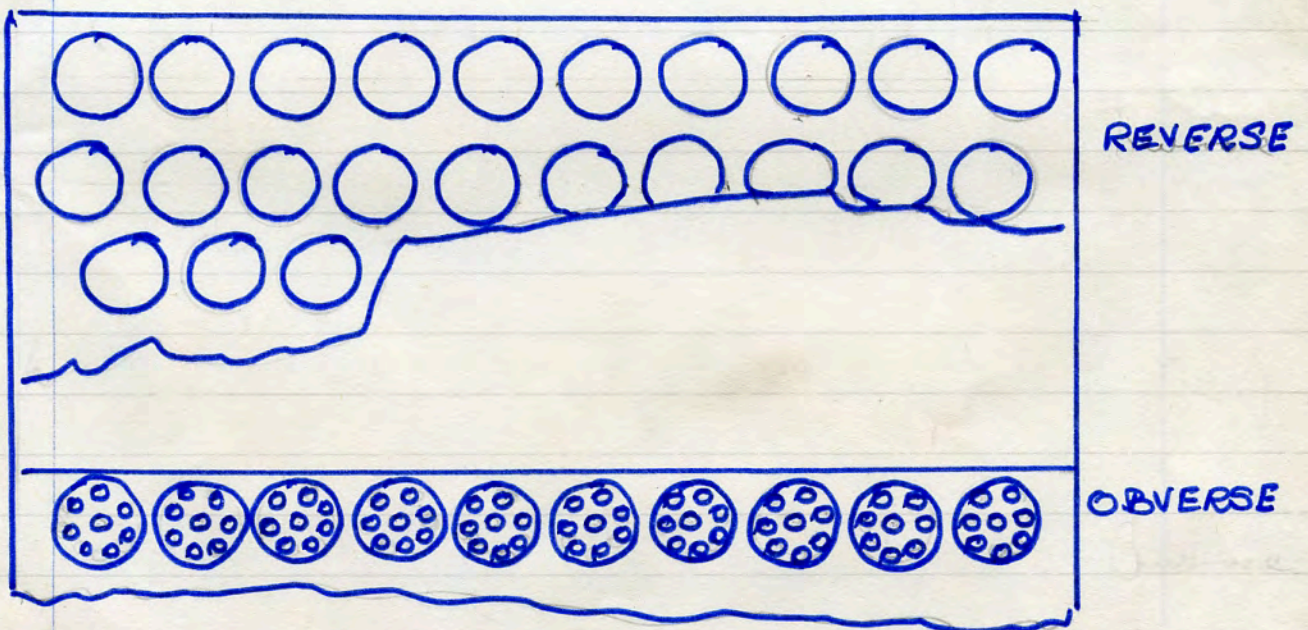

8 No name. Garden edge tile 9" x 8" x 1/8"
 Brown salt glaze on fire clay 5 1/2 lbs.
 Presumed Duckett's

x 2630

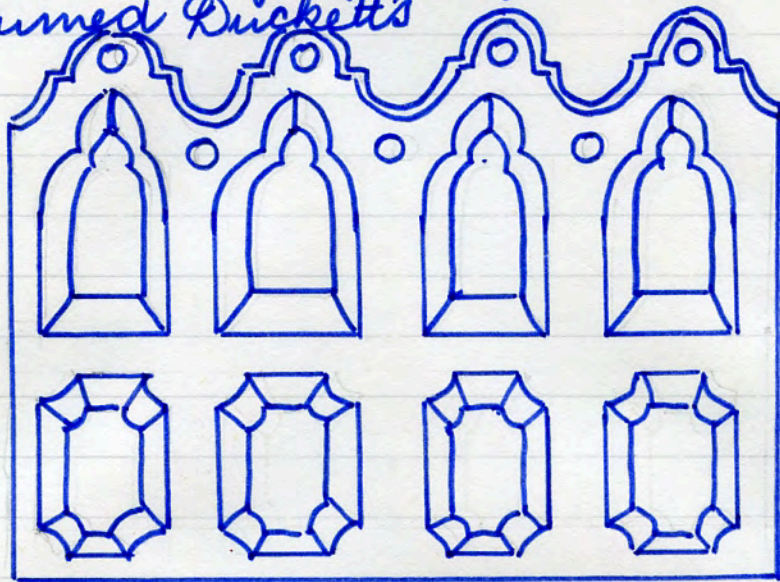

Rose Grove Rlwy Goods Station, Burnley 16. 6. 81.

2633 x

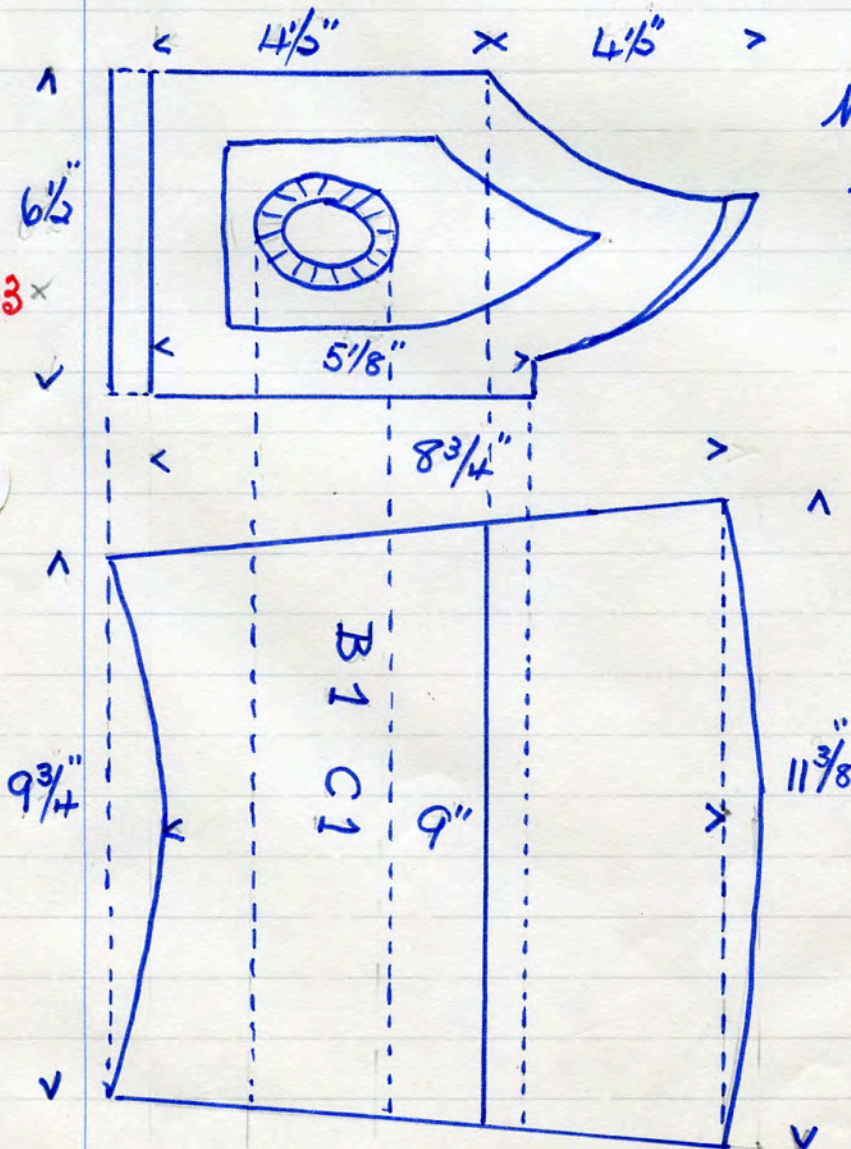

No name 32 1/2 lbs.
 chimney capping.
 terra cotta

13 3/8"

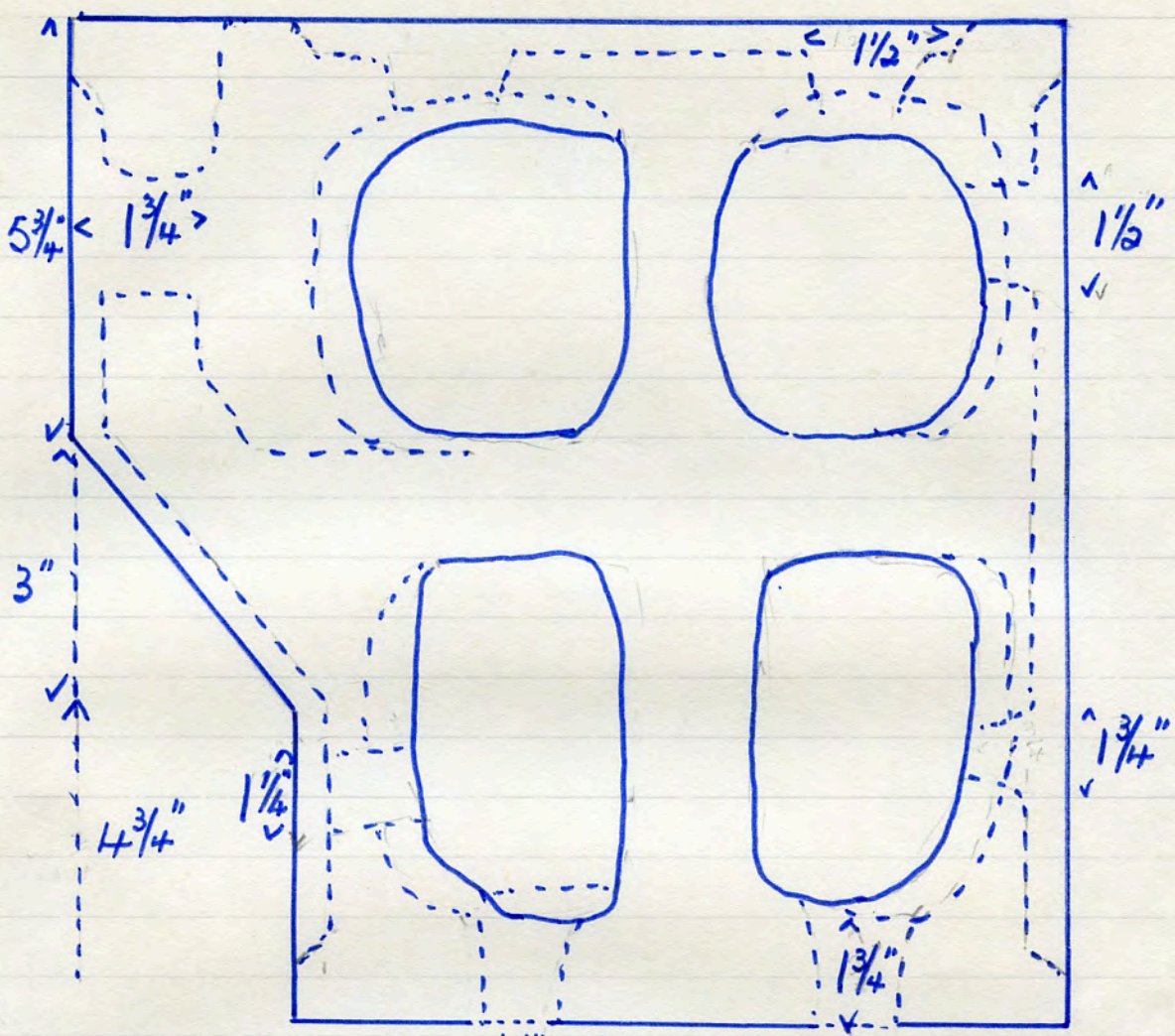

26 34

< 1 5/8 > 11"

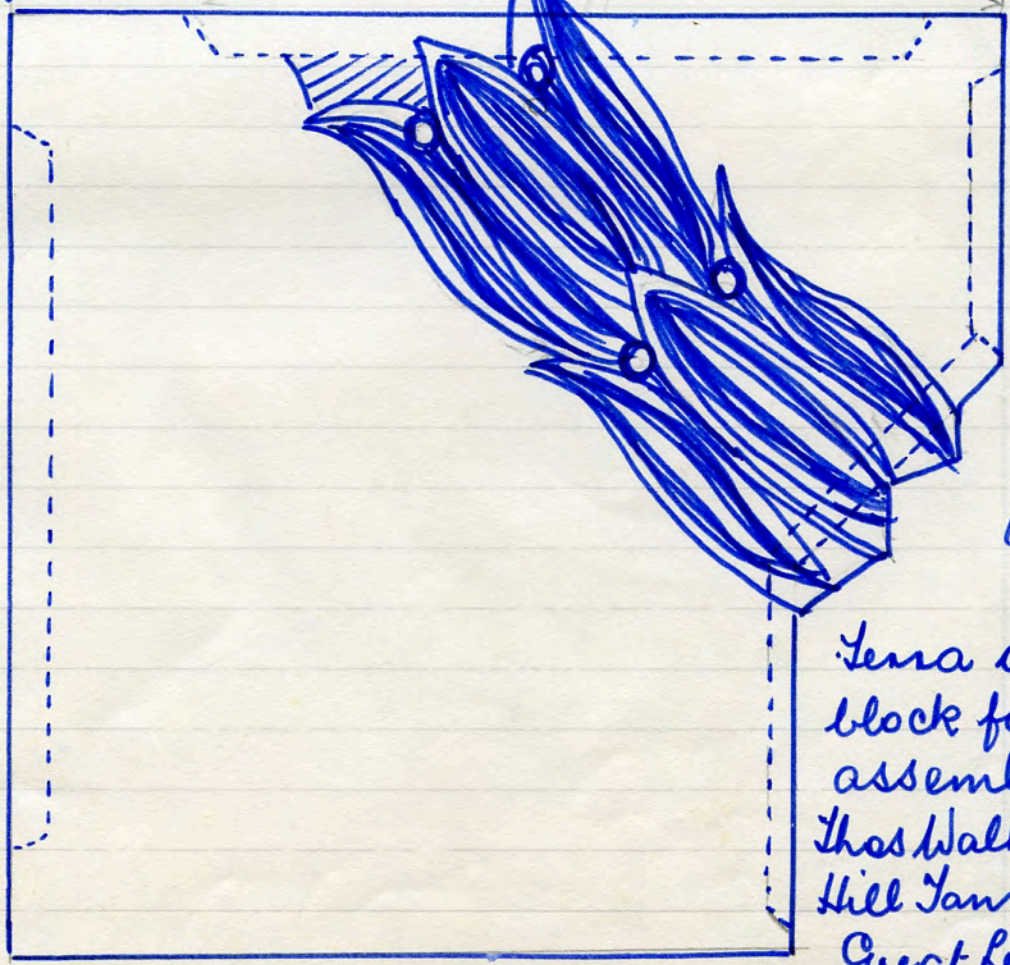

6 3/4" thick
68 lbs.

Terra cotta
 block for wreath
 assembly
 Thos Walker's, Rose
 Hill Tannery dem
 Great Lakes
 19. 4. 81

PM 105 lbs $13\frac{3}{8}" \times 13\frac{3}{8}" \times 11\frac{1}{2}"$
 terra cotta - part pillars and drapes.

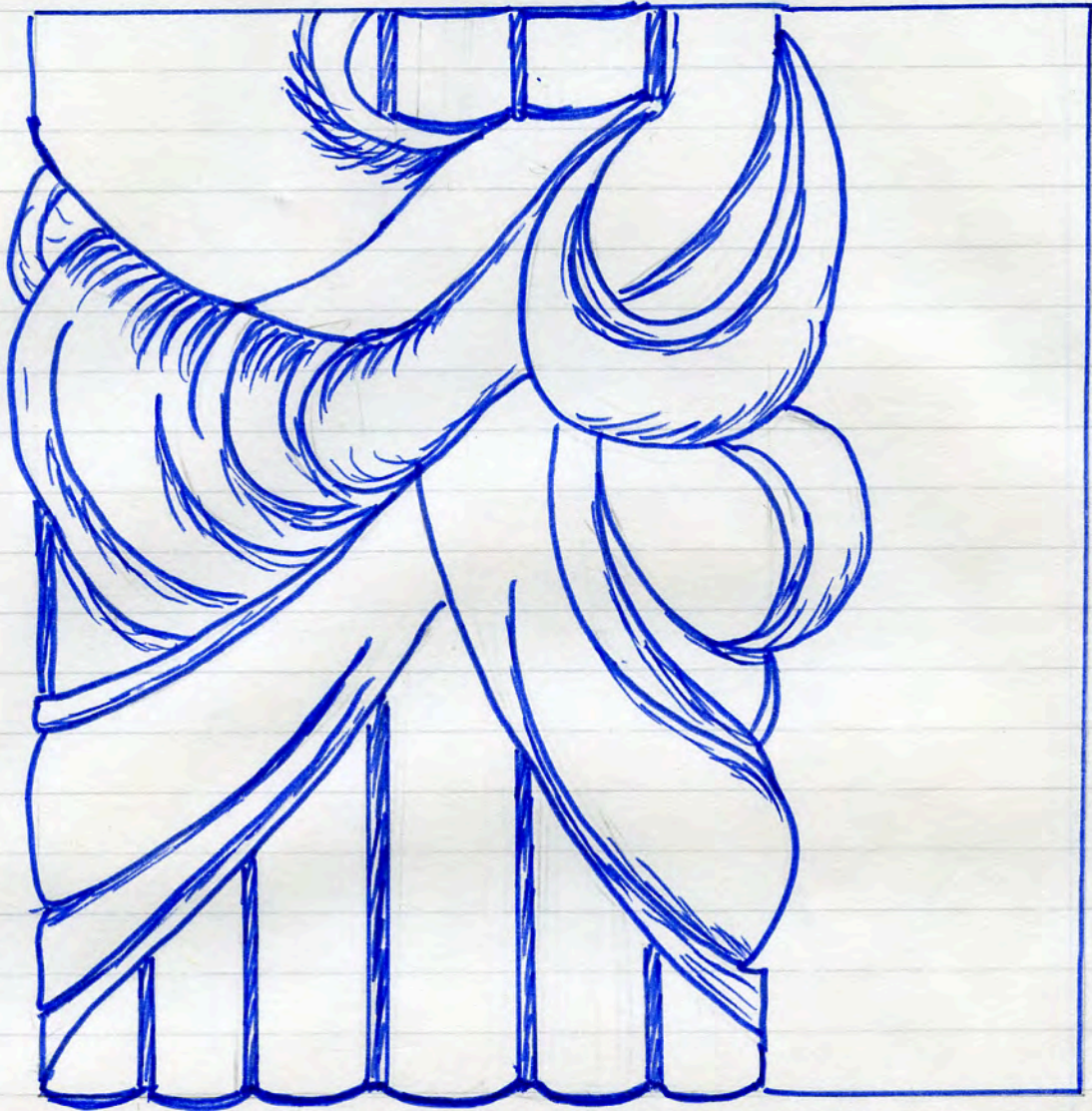

2635
x

Bedford Mill. BEDFORD MILL.
 Avon St. mill dem. Leigh 14. 5. 81.

2643
x

H terra cotta jamb (J. B. Edwards)
 9 lbs. $8\frac{13}{16}" \times 4\frac{5}{16}" \times 3\frac{1}{16}"$

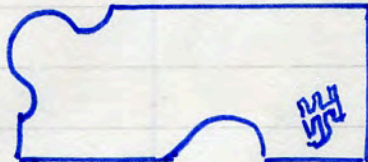

no panels, letters stamped.
 Fernel St dem. Victoria M/s. 2. 8. 81.

2644
x

G. TRAUNTER dec. gauged arch brick
 $7\frac{3}{4}$ lbs. $9" \times 4\frac{1}{2}" \times 3" - 2\frac{3}{16}"$

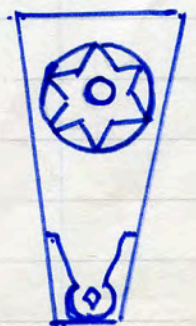

letters stamped on side.
 single panel in rev.
 Myrtle Cottage dem. Here St. Weaste.

2. 8. 81

2645 x No name (presumed TRAUNTER) dec stretch
 7 lbs. 9" x 3" x 3". projection 1"
 no panels. 3 star decoration.
 Myrtle Cottage dem Vere St dem
 Waste M/r. 2. 8. 81



2646 x No name (TRAUNTER?) single nail head.
 3 lbs. 3" x 3" x 3" - projection 1/8"
 no panels.
 Oakley St dem Waste. 2. 8. 81.

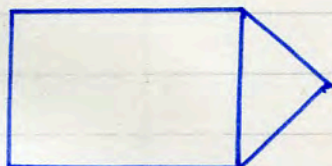

2649 x No name. red paver.
 10 1/2 lbs. 8 7/8" x 5 3/4" x 3"
 no panels. 4 large panels (raised)
 8 part diamonds
 Redishen Woods, Park Rd. Holcombe Brook. 13. 8. 81.

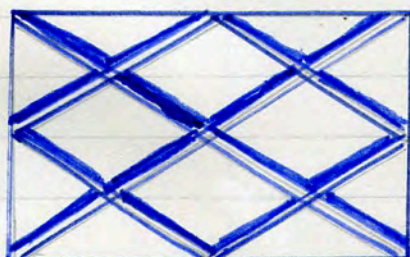

2654 x * RYDER clay bricks corbel.
 7 lbs. 8 7/8" x 4 1/4" x 2 3/4"
 single panel 1 side only 1" deep.
 letters in relief.

4 extraction pin marks

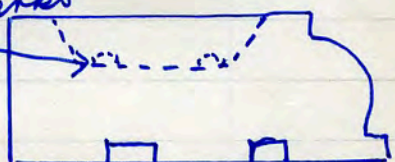

2 positioning holds in rel.

Brick dump, Queens Rd, Monsall, 23. 8. 81.

2658 x No name. dec. fire clay corbel.
 22 lbs. 13 3/4" x 5 9/16" x 4 3/8"

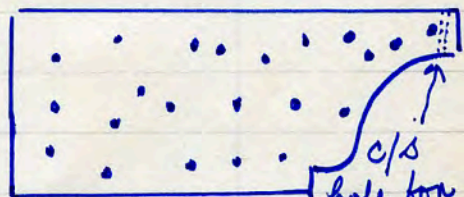

no panels. 22 small holes in
 1 side only (from kick board)
 Brick dump, Queens Rd. Monsall, 23. 8. 81.

2659 x BRADSTONE obv. S.C. RUBBLE rev.
 30 lbs. 20 1/2" x 4 3/4" x 4" imitation stone.
 single panel each side, letters incised

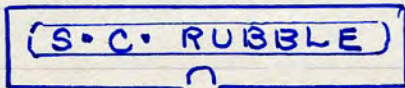
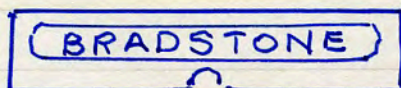

S. Spencer. St James the less R.C. Church. R/stall. 18. 8. 81

No name (LBC?) clay drainage tile

2661 x

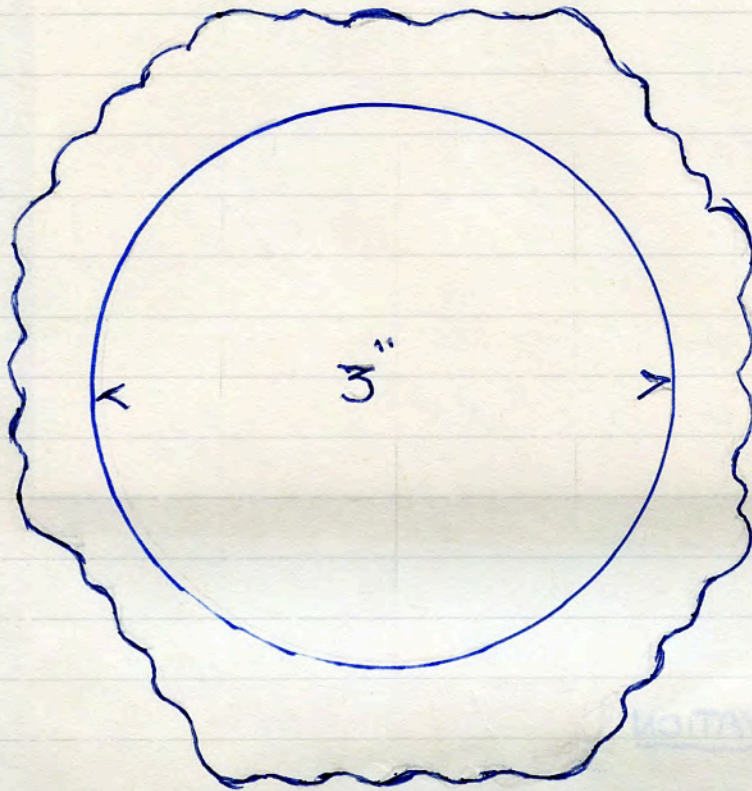

4 ¹/₄ \"

Length 11 ³/₄ \"
 v Weight 5 ¹/₂ lbs.

Mrs Ros. 20. 9. 81. Pateley Bridge.

No name. TC ventilator.

10 1/2 lbs 8 3/4 \" x 8 3/4 \" x 2 15/16 \"

Manchester Brick Dump. Queens Rd. Mossall.

23. 8. 81.

2672 x



2644



FRONT ELEVATION

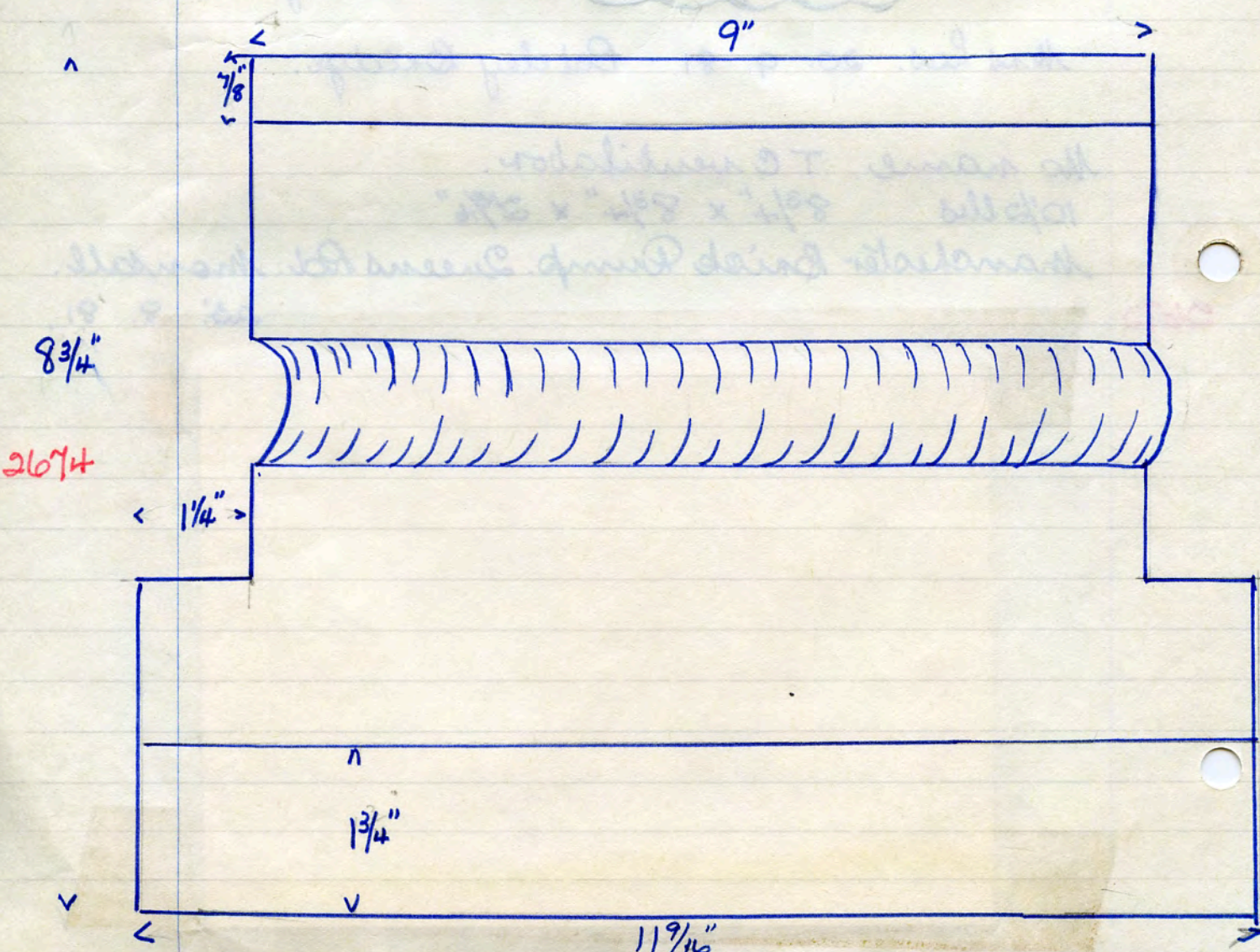

J. C. EDWARDS TERRA COTTA WORKS RUABON. N. W

30 lbs. $13\frac{3}{8}$ " x $13\frac{3}{8}$ " x $2\frac{1}{2}$ "

x terra cotta decorative panel. floral

2673

Alkrington Rd mill dem. Middleton 23. 8. 81.

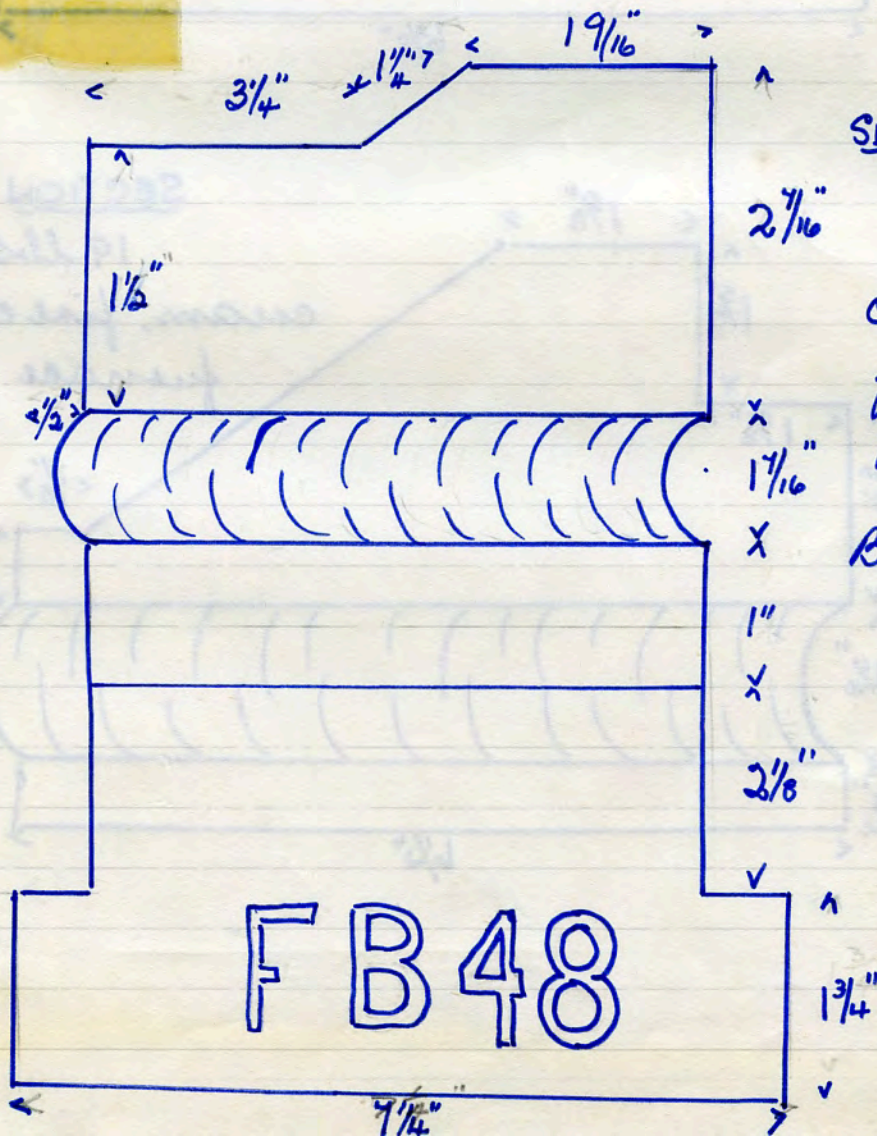

SECTION.

$2\frac{7}{16}$ "

39 lbs.

cream
fine clay
furnace piece

4. 10. 81.

Blackley,
Elland.

x
 $1\frac{7}{16}$ "

x

1"

x

$2\frac{1}{8}$ "

v

$1\frac{3}{4}$ "

$7\frac{1}{4}$ "

2674.

x

2675 x

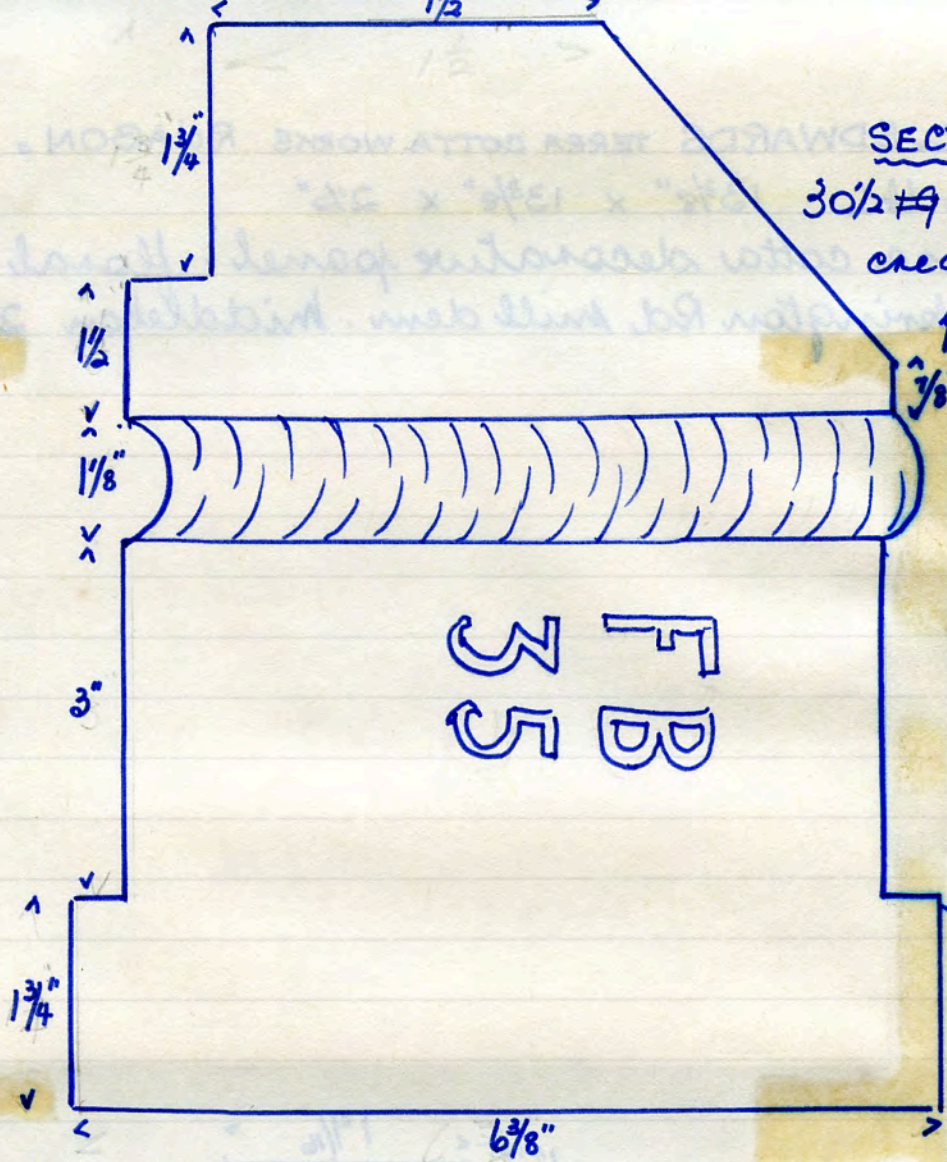

SECTION
 30 1/2 #9 lbs
 cream, fire clay
 furnace piece
 4. 10. 81
 Blackley,
 Elland

2676 x

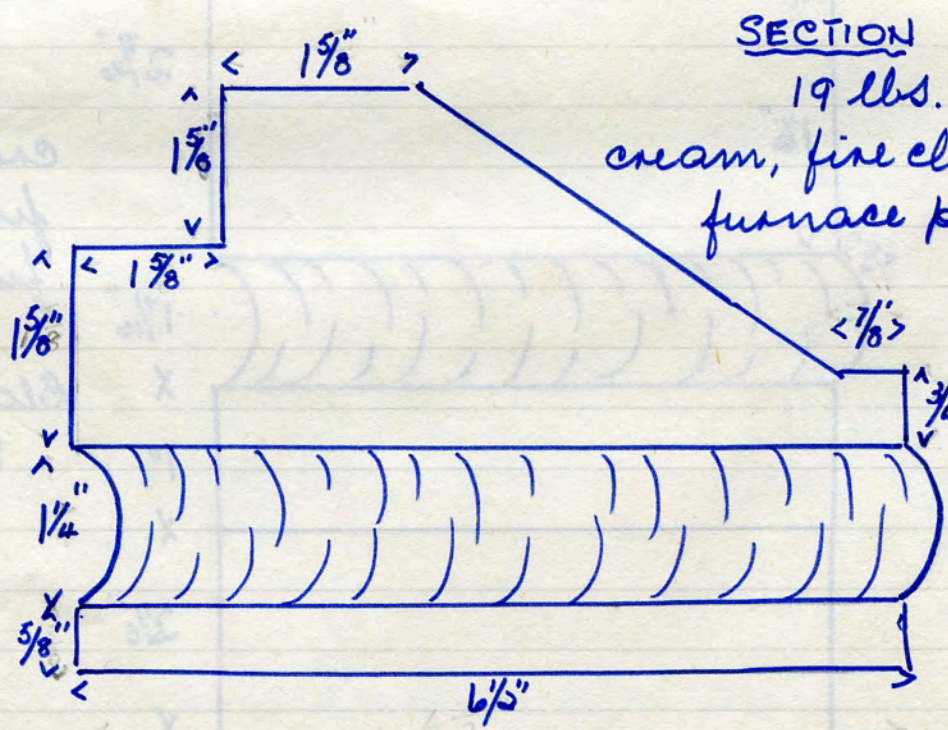

SECTION
 19 lbs.
 cream, fire clay
 furnace piece
 4. 10. 81
 Blackley,
 Elland

2675

x



2675



2676

21.1.12

2675

$\frac{1}{8}$ "

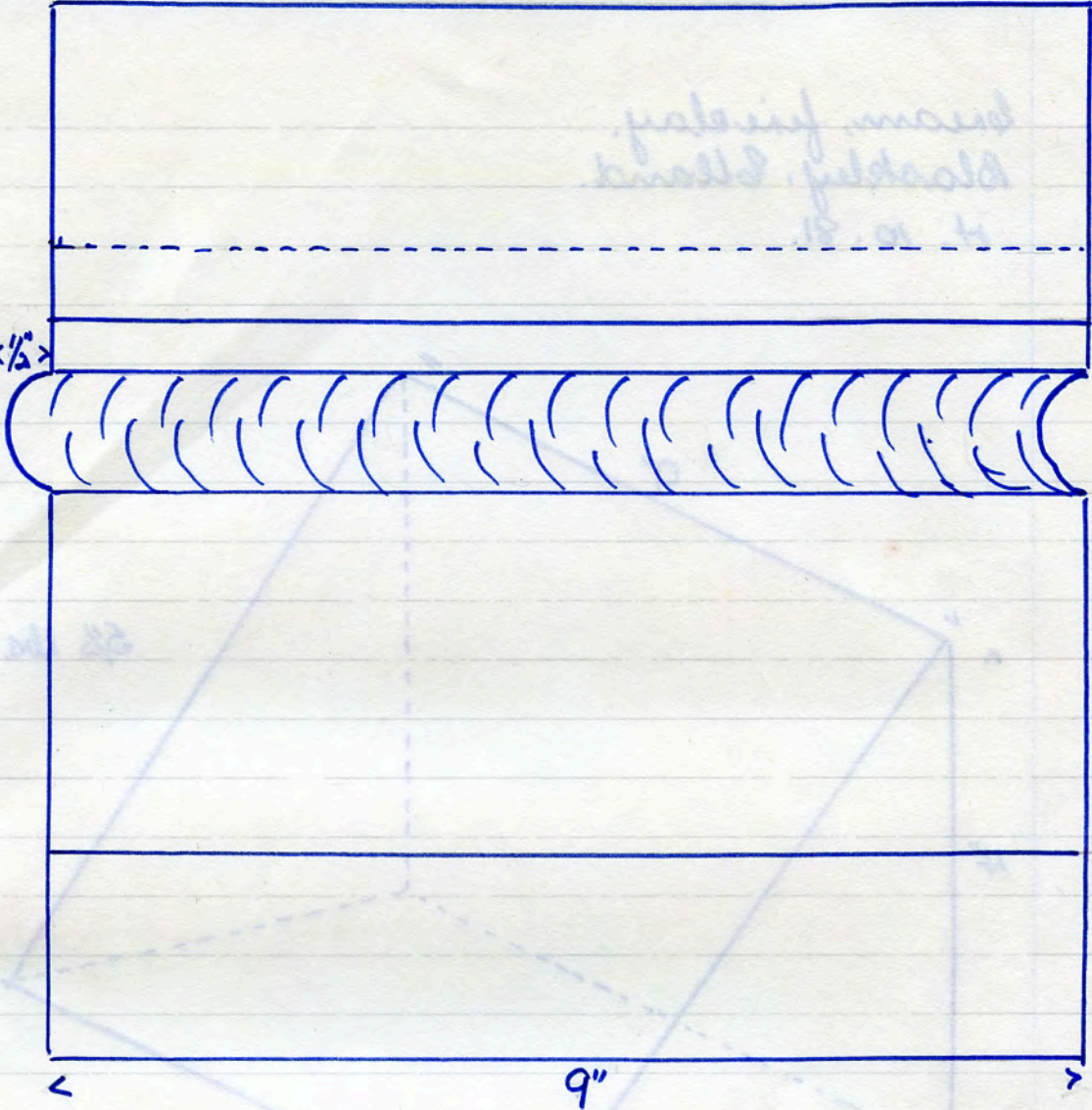

FRONT ELEVATION

2676

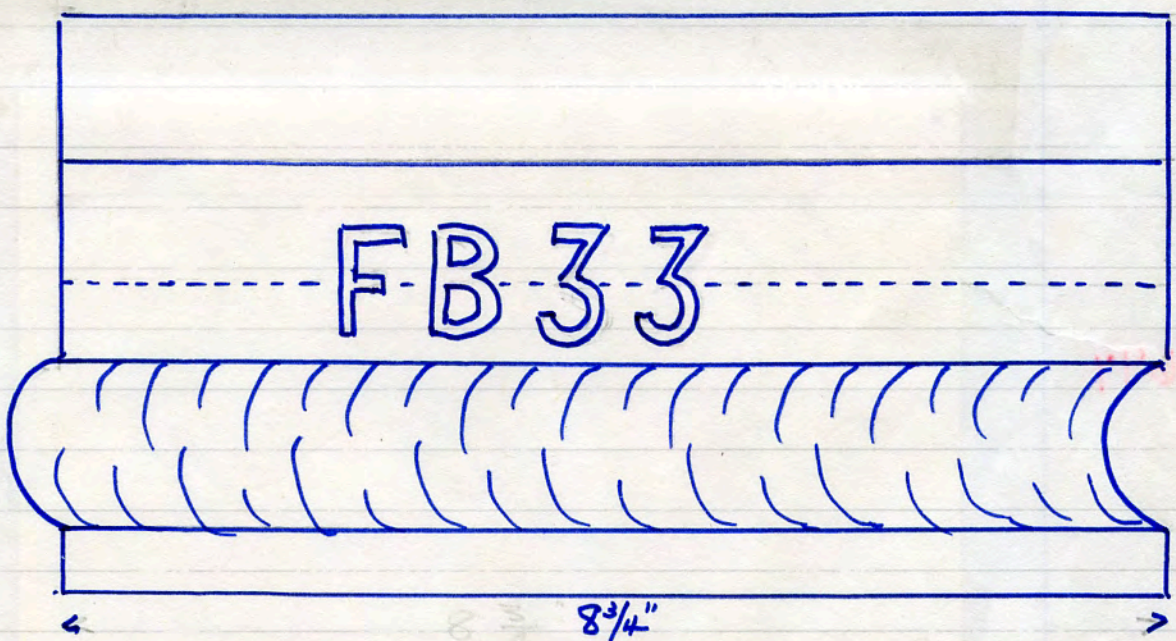

FRONT ELEVATION

cream, fine clay.
Blackley, Eland.
H. 10. 81.

2678
x

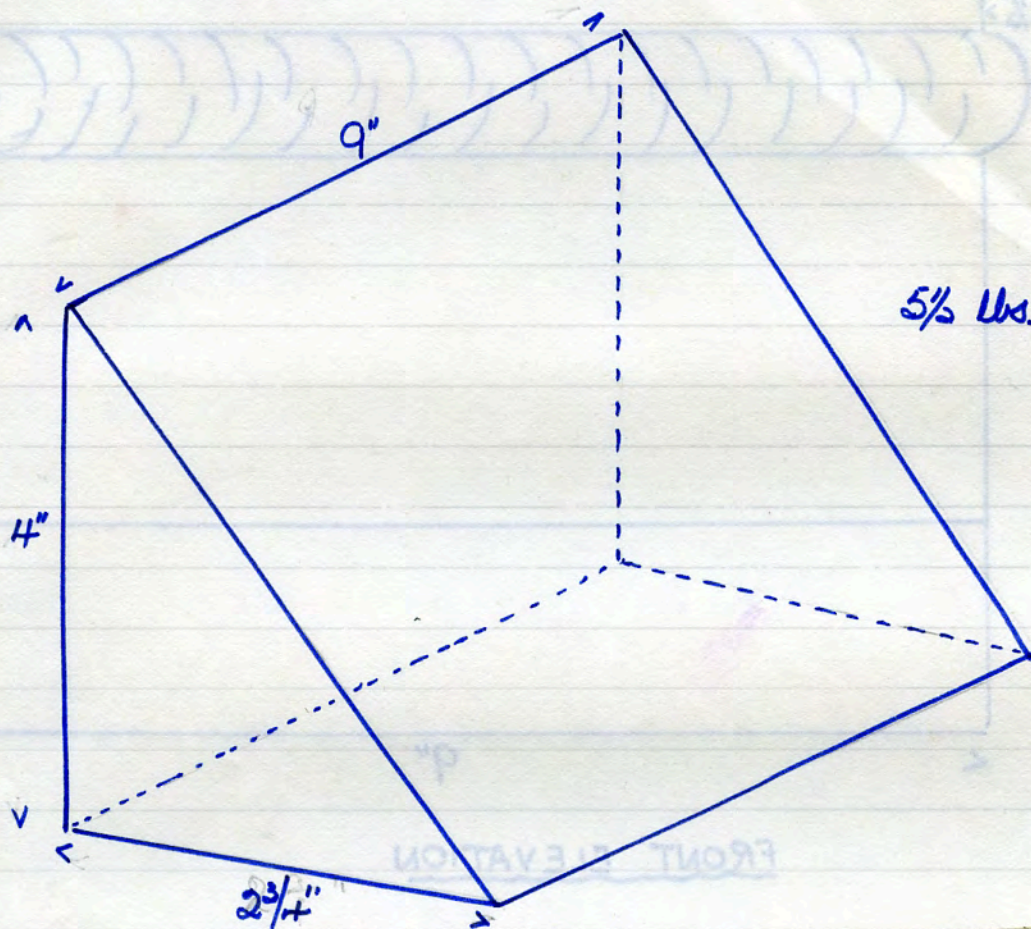

2677



8 1/2" overall width
9" " length
28 lbs.

cream fine clay.

Blackley, Eolland
H. 10. 81.

2644.
x

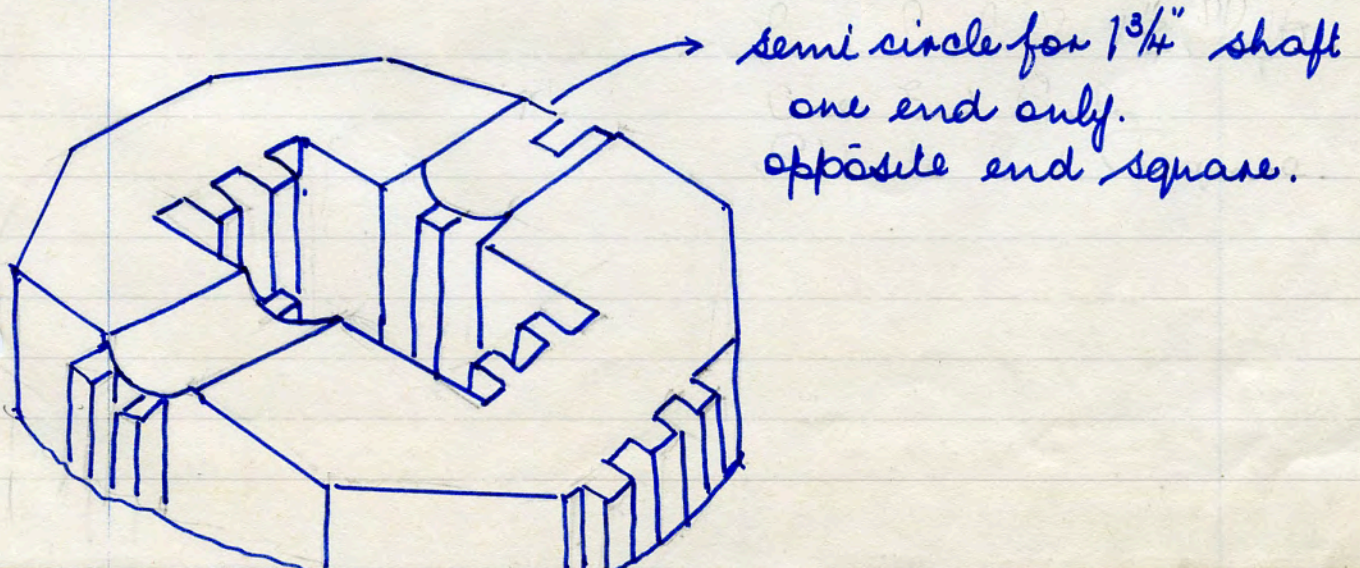
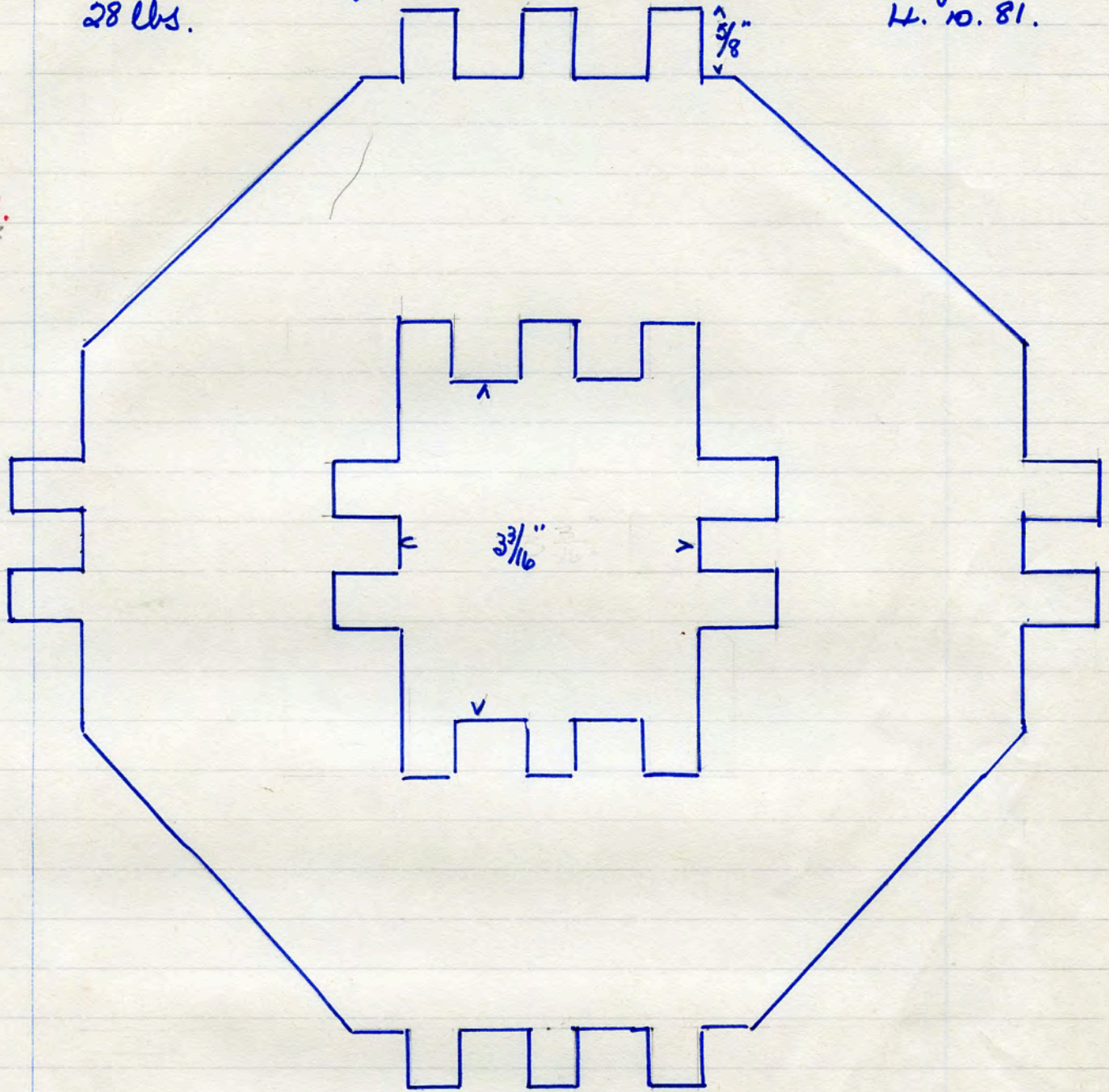

Decorative buff terra cotta. Delta Mill, Rayton
 No name, stamped S4D 28. 10. 81.
 14 lbs.

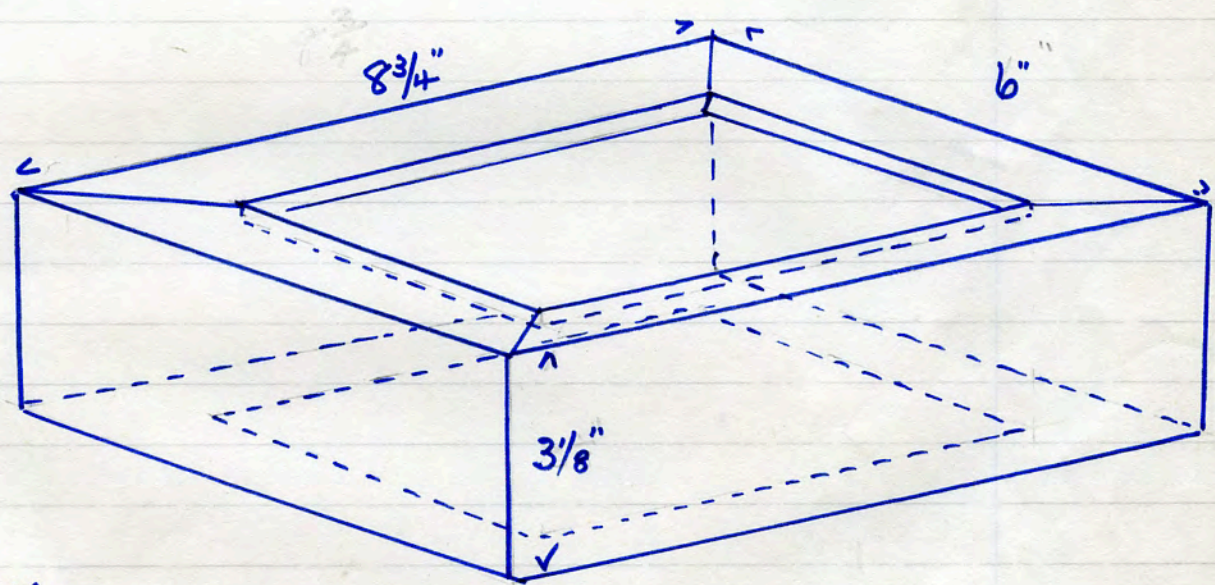
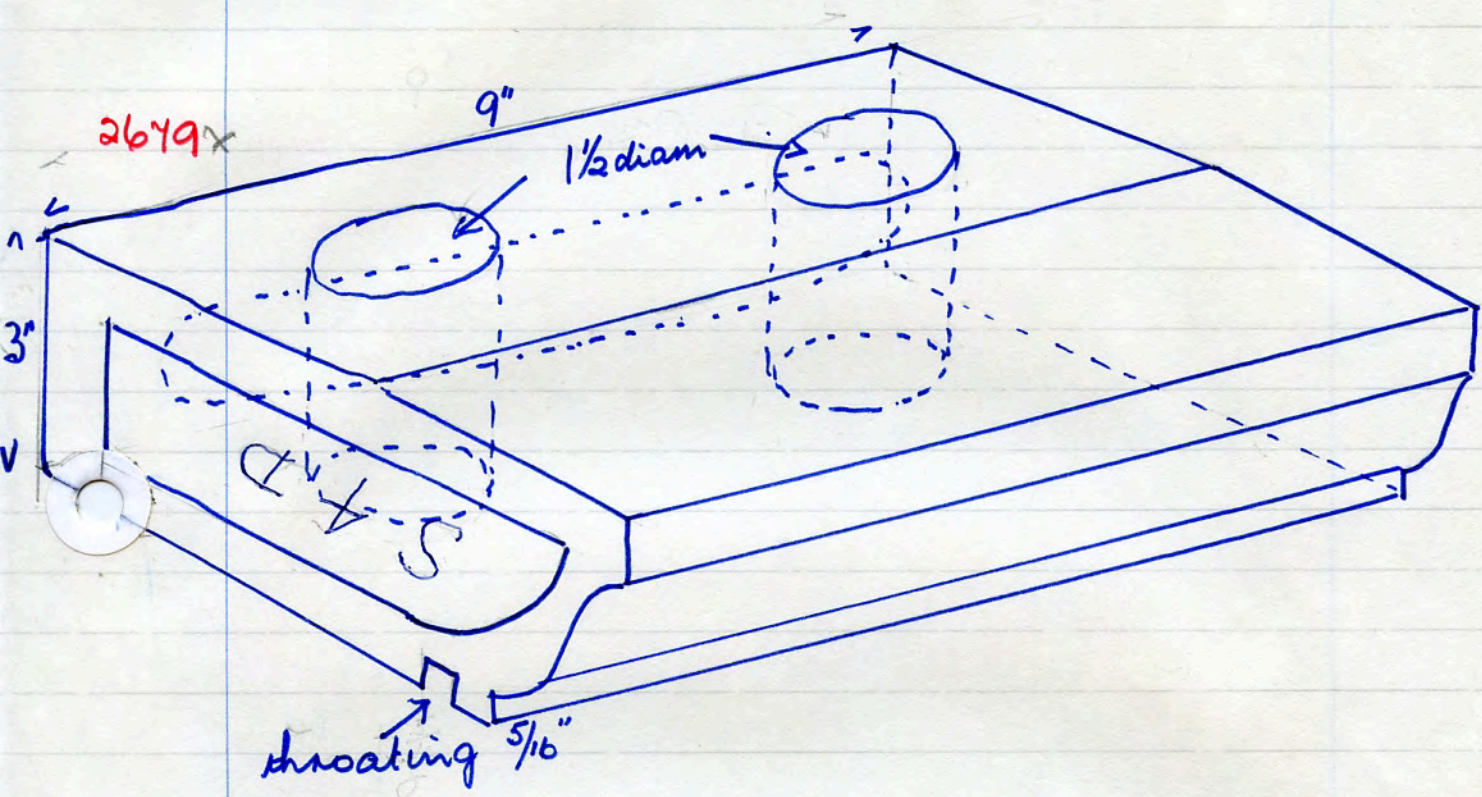

13 lbs.
 purpose made large brick - Delta Mill
 buff T.C.

Decorative buff terra cotta. Delta Mill, Rayton
no name.

28. 10. 81.

22 1/2 lbs.

2681 x

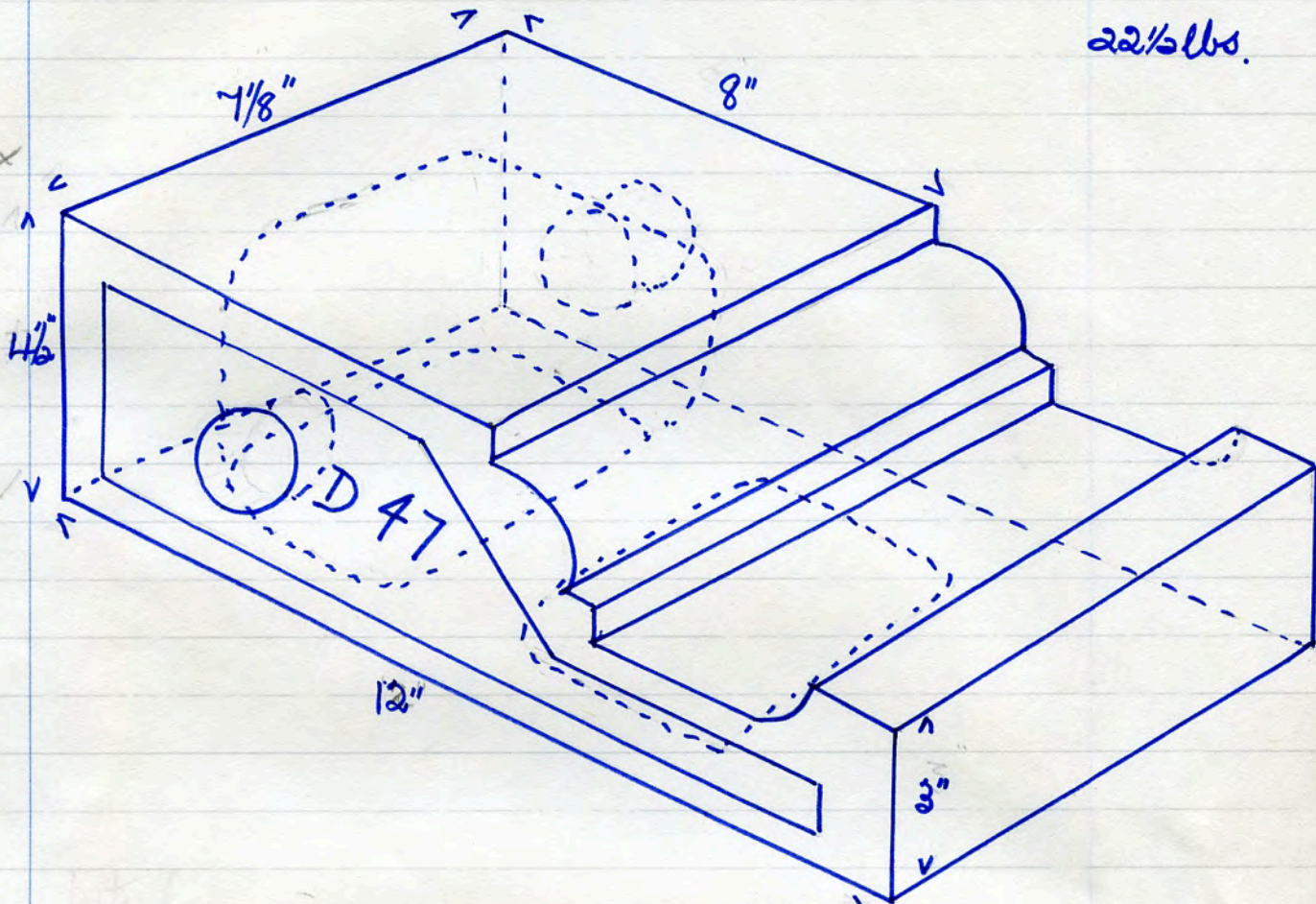

2682 x

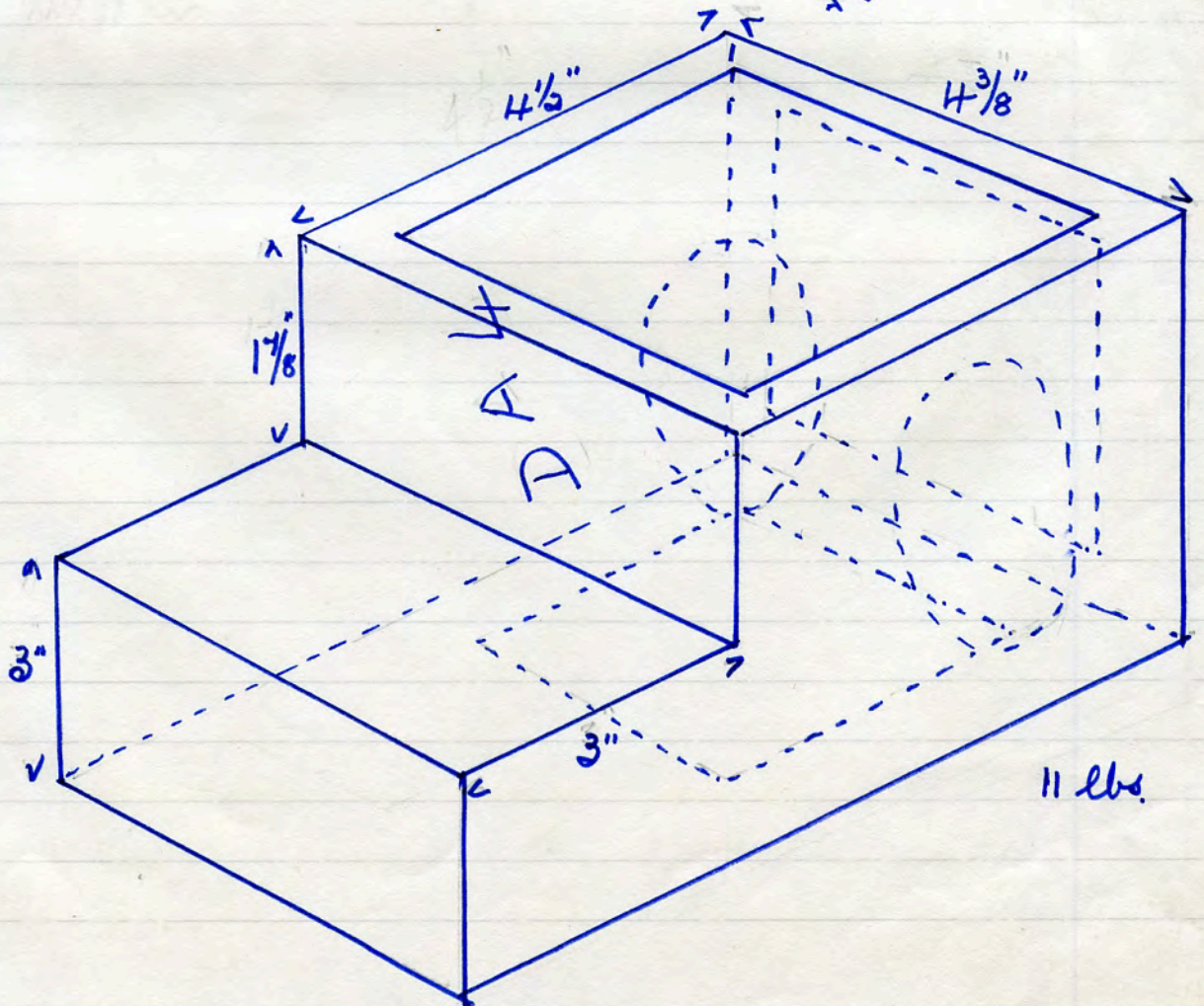

No name. Terra cotta header

10 1/2 lbs

2686 x no panels.

bastlecroft Bury, fire at Methodist
Chapel 11. 10. 81.

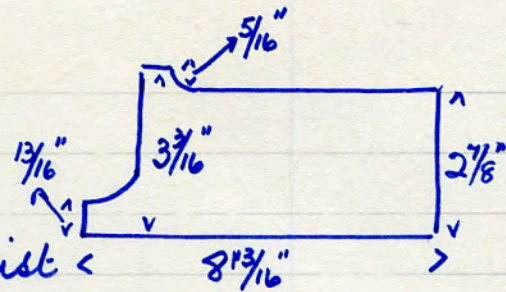

M729-98B Sisitacin DIDIER



2405 x

Draycott St. Bolton 31. 5. '81

No name R 348 buff cornice mould.

11 lbs. 11" x 4 1/2" x 3"

no panels. stamped 1 side.

2411 x

(presumed - Dennis Ruabon -
found with other bricks bearing name)
Loss Mill (dem) Bacup 3. 1. 82.

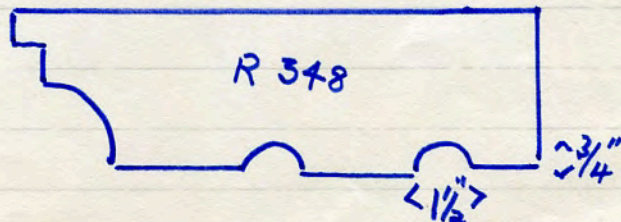

no name, path edge tile
salt glazed.

5 lbs. $8\frac{3}{4}'' \times 4\frac{1}{8}'' \times 1''$

2716 x

rose, thistle + shamrock
decoration, in relief

Mr. G. Kenney, Knoff St. Bascup.

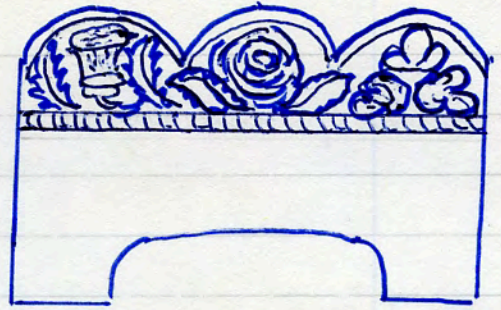

no name. Cornice mould.

17 1/2 lbs. T.C.

$6\frac{3}{4}''$ Overall

2719 x

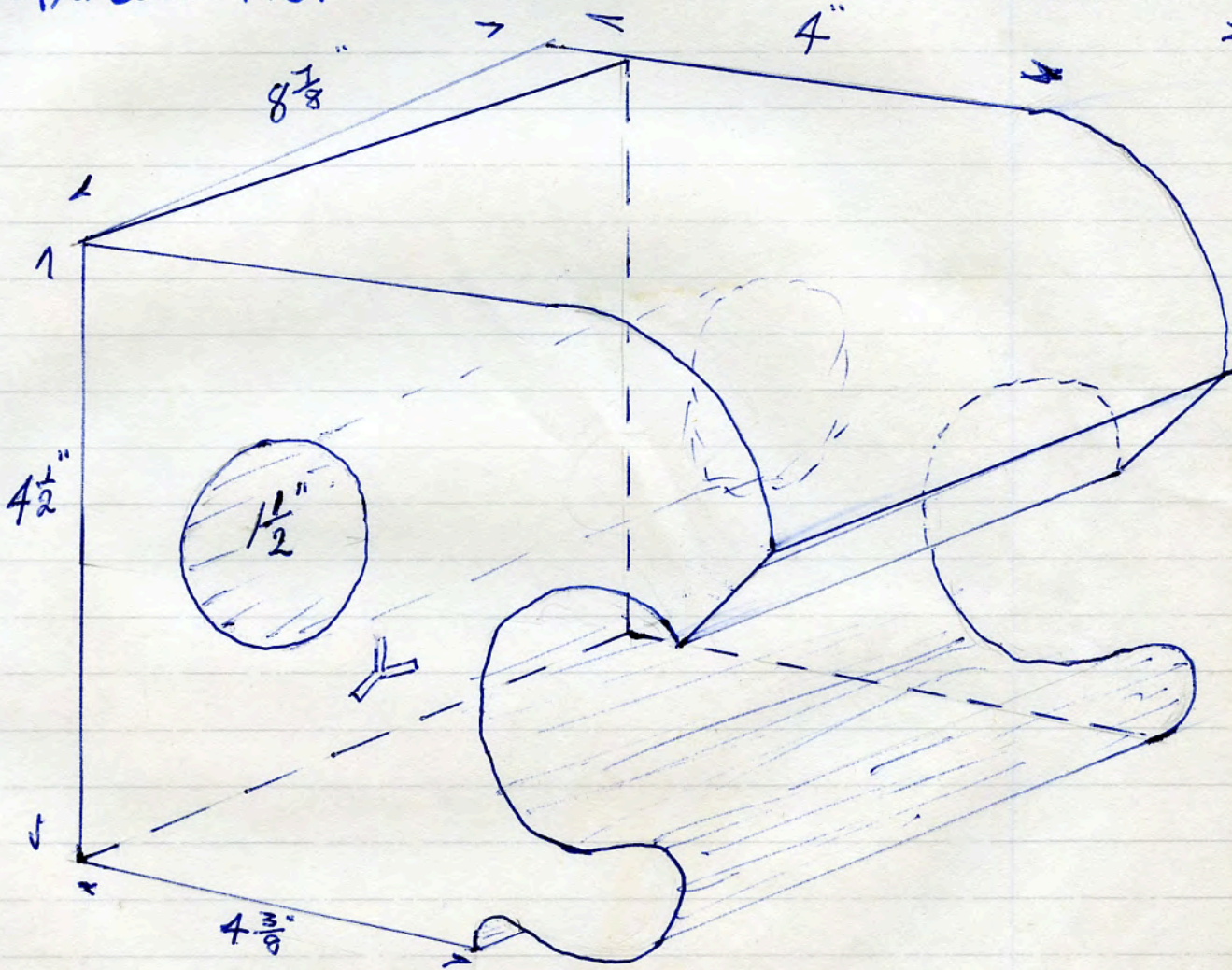

Convent School dem. Bignot St. Litcham Mfr.

31. 1. 82.

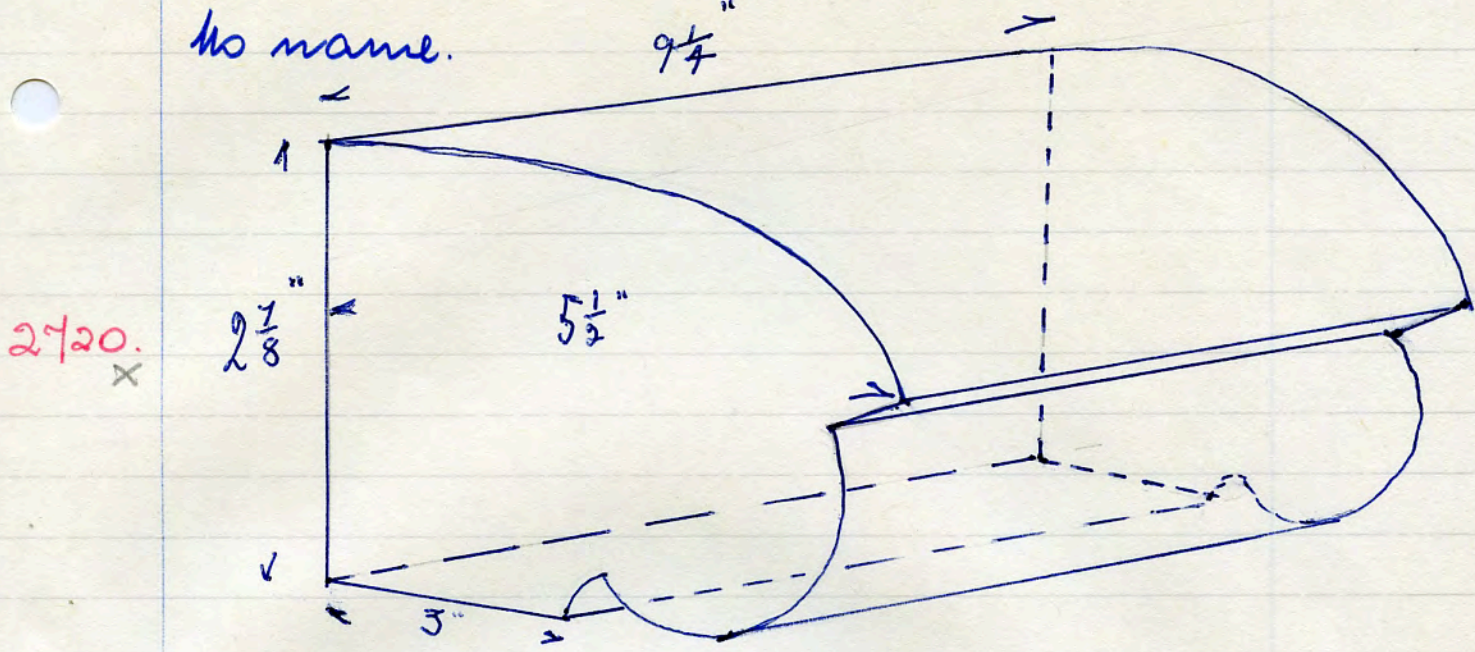

2720.
x

T. C. cornice mould. no panels.
 12 1/2 lbs.
 Benvent School dem. Bignon St. Leetham, Mfr.
 31. 1. 82.

DENNIS RUABON  R 286 buff T.C. cornice mould

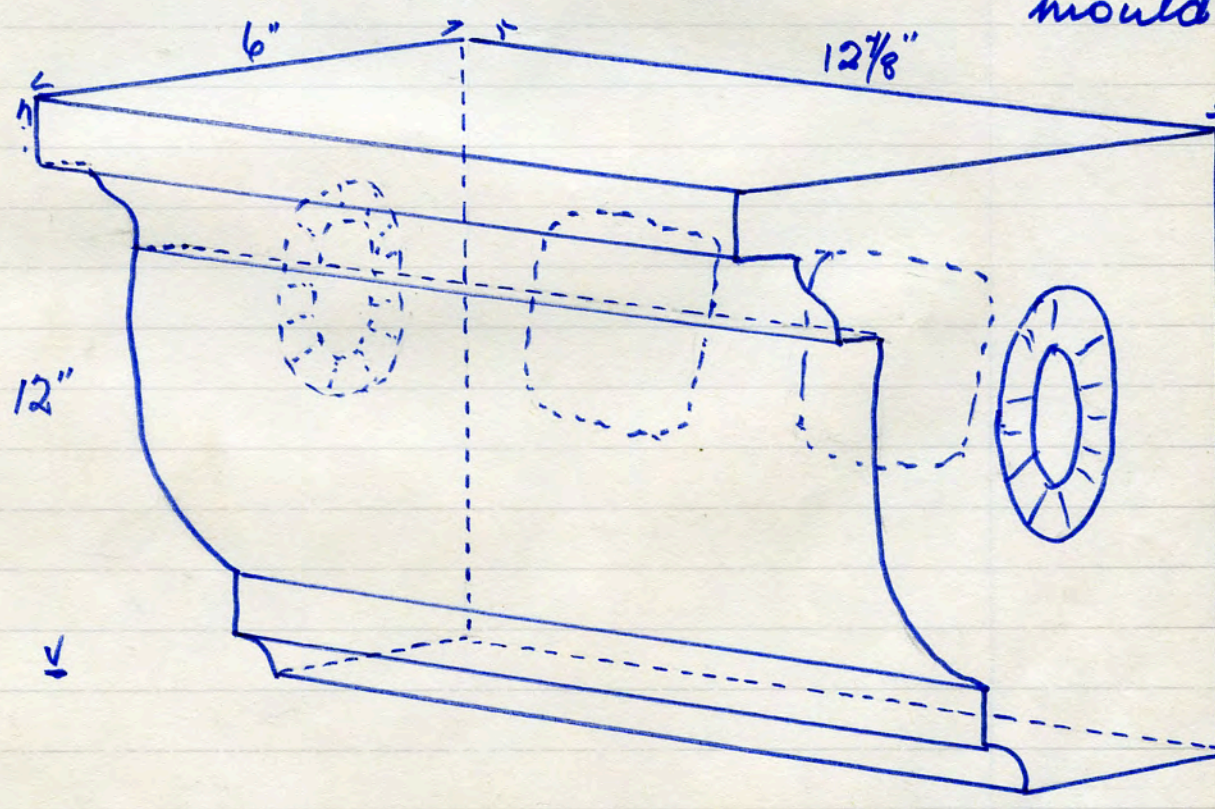

2725.
x

70 lbs - (full of aggregate).
 name and no. incised on rev.
 Ross Mill dem. Bacup. 3. 1. 82



No name. Red T.C. ventilator.

4 lbs. 9" x 6" x 3"

x2731

Ent Bridgewater dem.

Deansgate, M/n. 4. 2. '82.



ALYN TERRA COTTA
WORKS
MOLD

x2732

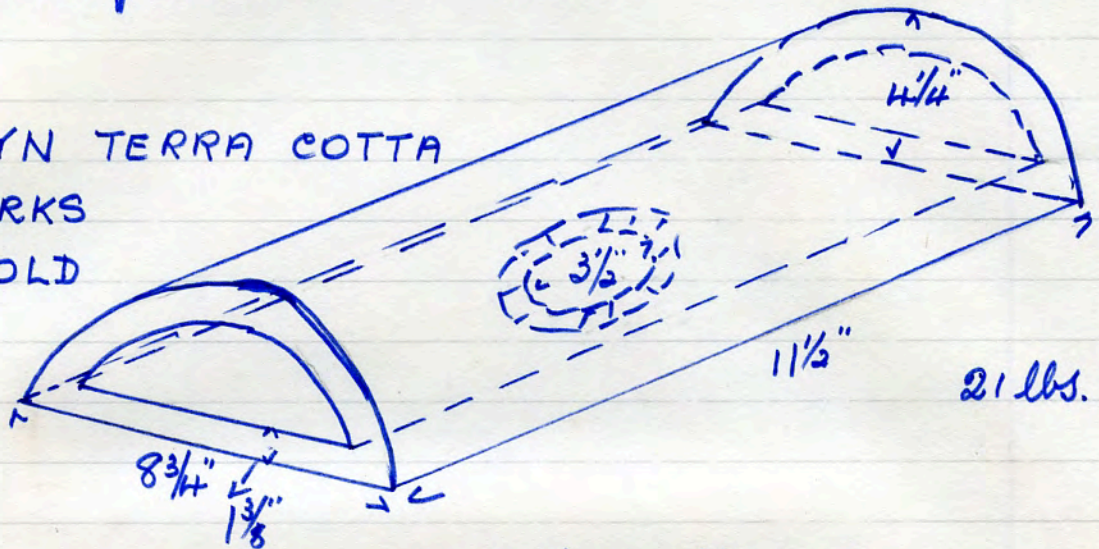

red wall cap.

dem Bower St, Waterloo Rd, Bletcham 4. 2. 82.

No name.

16 1/2 lbs.

T.C cornice return, no panels. 2 perfs.

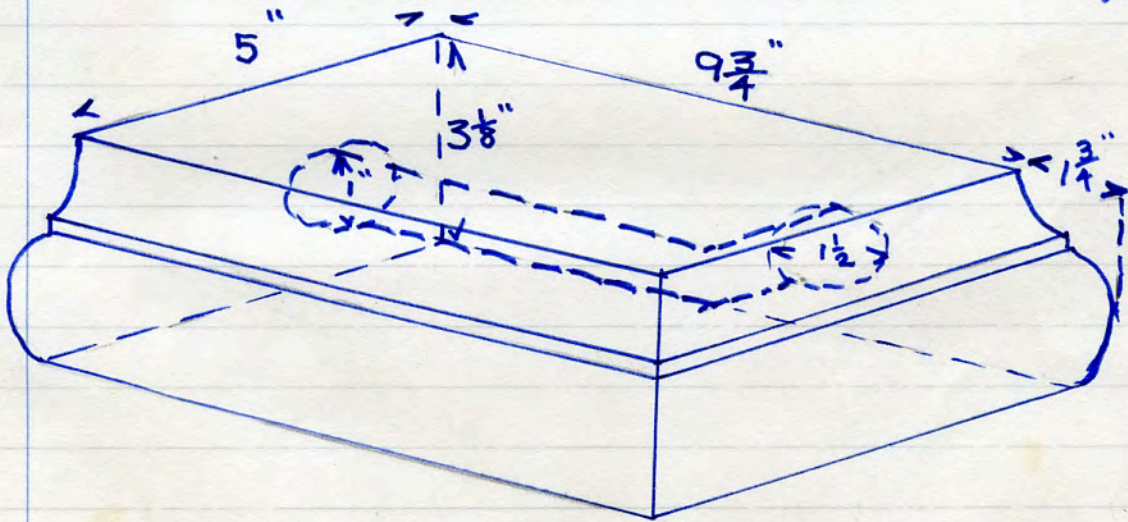

x2733

dem. Bower St- Waterloo Rd. Bletcham. 4. 2. 82.

No name. blue floor brick.
10 lbs. $8\frac{3}{4}'' \times 4\frac{3}{8}'' \times 2\frac{3}{4}''$



2743

6 chamfered studs
single panel rev. with inset
Allenbrook St. Canton 21. 2. 82

No name. T.C. $\frac{1}{2}$ return dec wall capping.

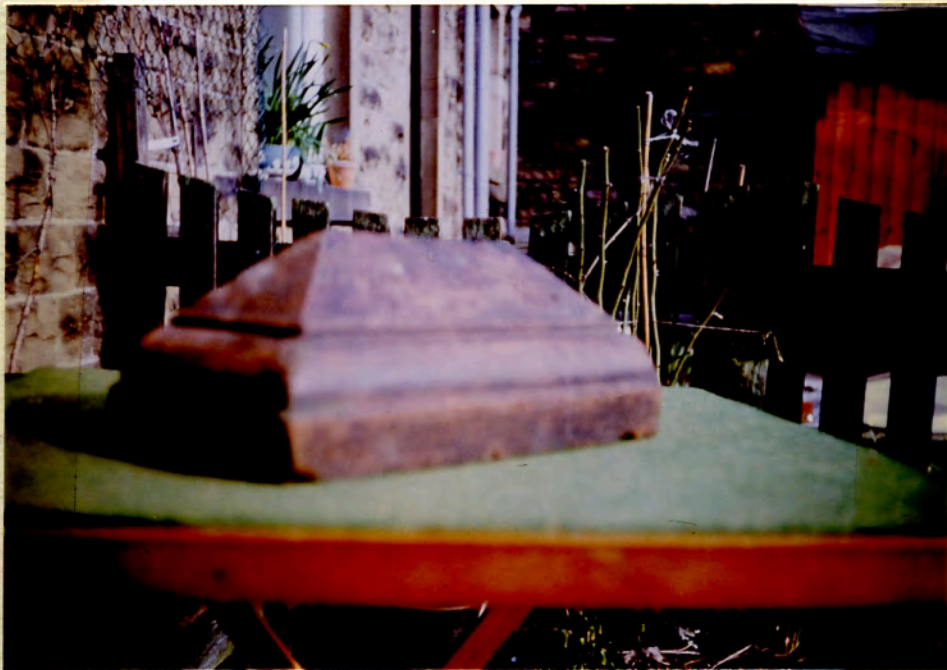

2740

16 lbs.
 $12\frac{1}{8}'' \times 6\frac{1}{8}'' \times 4\frac{3}{4}''$

Every St.
Arcoats.
old R/wy
Stables.

28. 2. 82.

No name. boss. red

- 2454 ① dec. brick. Tudor rose in relief
11 lbs. $6" \times 6" \times 3"$. projection of flower $1/16"$
- 2455 ② dec. brick. Greek key in relief, red
10 lbs. $6\frac{3}{8}" \times 5\frac{1}{2}" \times 4\frac{3}{8}"$ over all. projection $3/4"$
part of dec. string course
- 2456 ③ dec. string course. red. cable.
8 lbs $9" \times 3\frac{3}{8}" \times 3\frac{3}{16}"$ projection $1\frac{3}{8}"$
- 2457 ④ dec. string course, red. flower & scroll.
similar in design to No. 1496 (Wigan)
8 lbs. $9\frac{1}{8}" \times 3\frac{3}{4}" \times 3\frac{1}{8}"$ projection $1\frac{1}{4}"$

All the above bricks were from Vernon St. Bolton
dem. maker unknown, but presumed ORMROD.
Building had date stone 1849. 14. 2. '82



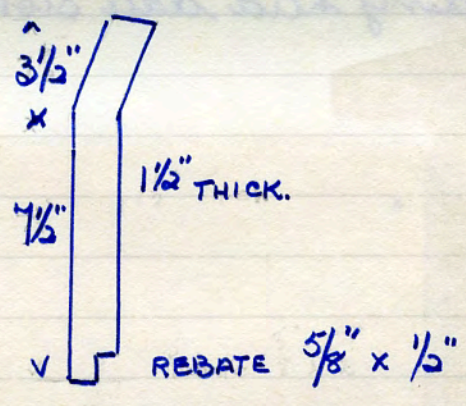
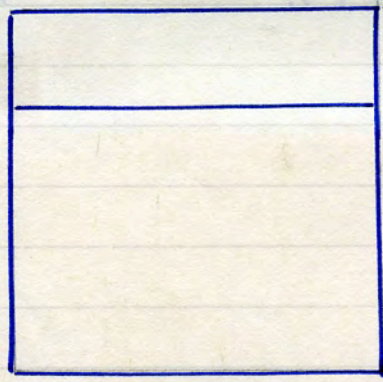
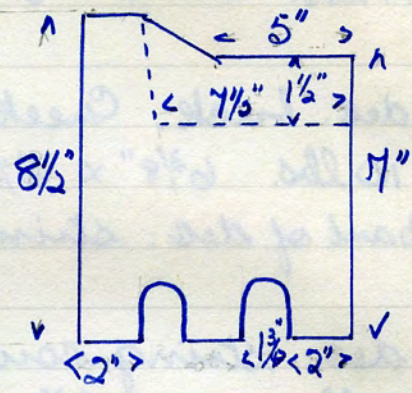
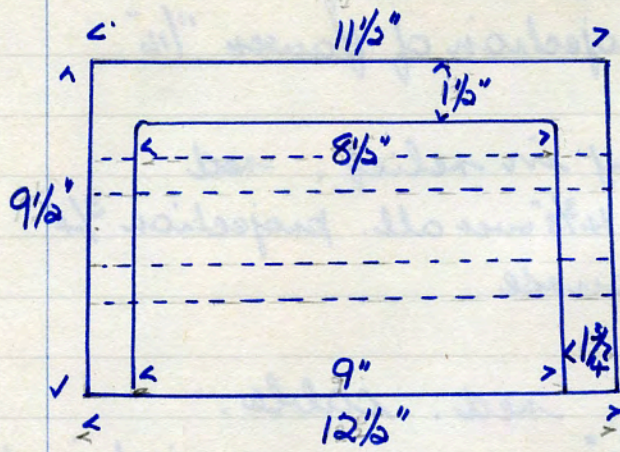

No name, R122 No 4 special fine clay grate (base)
R30 back for grate.
Tip - Snowden's Bridge, Waterfoot. 15. 2. 82.

2471.



2471



INGHAM & SONS

WORTLEY

LEEDS

Salt glazed, fire clay manger. (in situ).
Ancoats (Palmerston St). Lancs & Yorks Railway
Stables.

28. 2. 82.



2772

No name. Salt glazed air vent.

4 1/2 lbs. 9" x 3 1/2" x 2"

no panel. 8 perfs 1 3/4" x 1/4"

2780 Cranborne St. Preston. H. H. '82

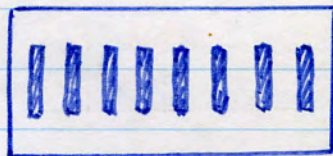

No name. Salt glazed air vent (part).

2 1/2 lbs. 9" x 6" x 2 1/2" (when whole).

panel 1 side, plain new.

4 perfs (in part) 4" x 3/8". O at end 5/8"

2781 Cranborne St. Preston H. H. '82

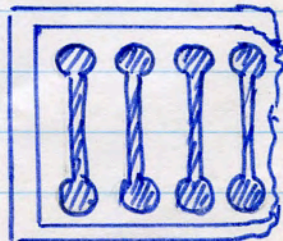

No name. red T.C vent.

2 lbs. $8\frac{7}{8}$ " x 3" x $2\frac{3}{8}$ "

4 apertures $3\frac{1}{4}$ " x $\frac{1}{4}$ "

2782

Water Lane, Sulkeith Broom.

Preston. 4. 4. '82

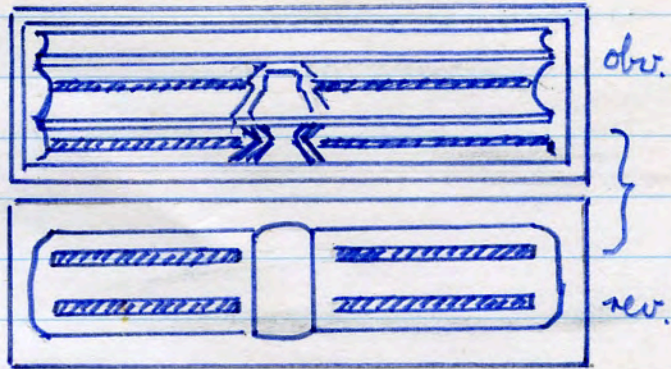

JOHN MASON FAIRFIELD red. clay dec. stretcher.

6 lbs $9\frac{1}{2}$ " x $4\frac{1}{2}$ " x $3\frac{1}{4}$ " hand made.

note - letters N marked wrongly + spelling error in FAIRFIELD

2785

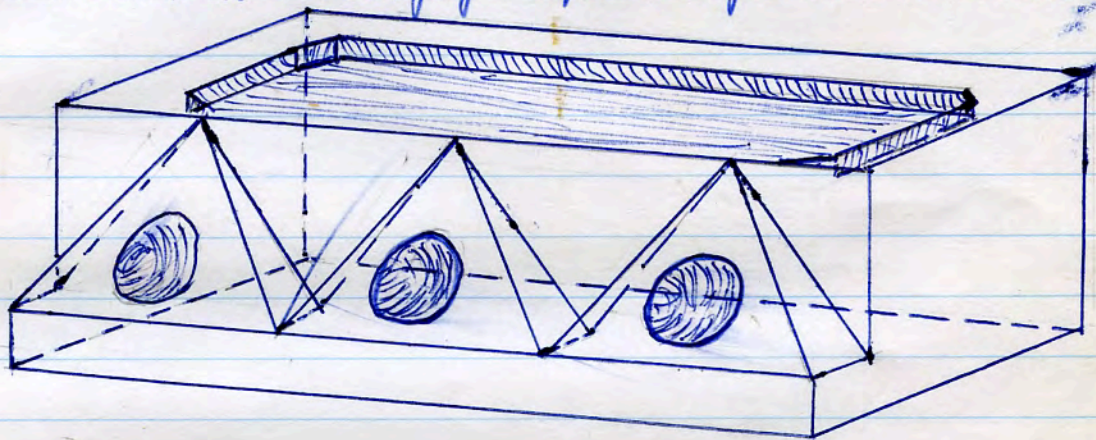

Apparently, this was originally pressed out as a common brick with a single panel on each side. Later, the decoration was processed on one side for use as a stretcher

Richard Burch St. Buny. 8. 4. '82.

No name, dec clay stretcher.

7 lbs. 9" x 4" x 3"

2800

no panels.



3 x 4 petal flowers in relief.

John Brown St, off Vernon St, Bolton 18. 4. '82.

2789 T. GRIFFITHS & SON. MANCHESTER. MOUNSEY'S PATENT
 18 lbs. $11\frac{3}{4}" \times 5\frac{1}{2}" \times 4"$. Salt glazed, fire clay spillet
 $1\frac{3}{4}"$ projection no decoration.

Lanch St., Oldham. 4. 3. '82



S 3 11 T T.C. sill with tenon, nosed return with
 35 lbs. $11\frac{1}{2}" \times 11\frac{1}{2}" \times 7"$ to " top water groove. $\frac{5}{8}" \times \frac{1}{4}"$ round
 $5\frac{1}{16}"$ to top of sill.
 stooling $6\frac{1}{4}" \times 6\frac{1}{4}"$. Vernon St dem. Bolton.

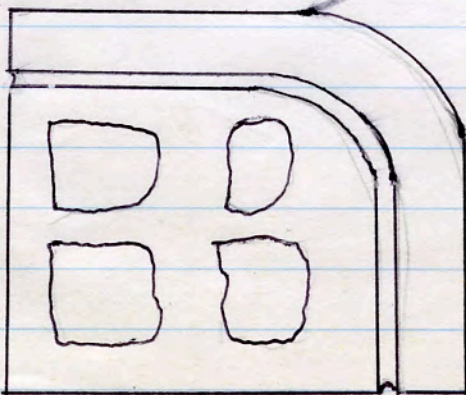
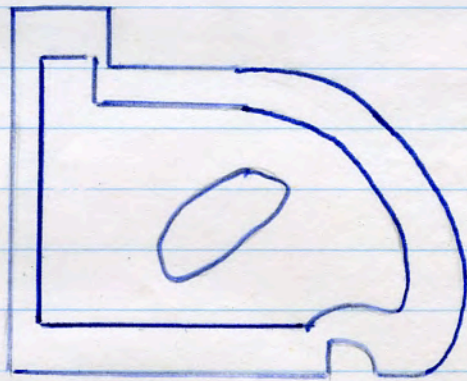
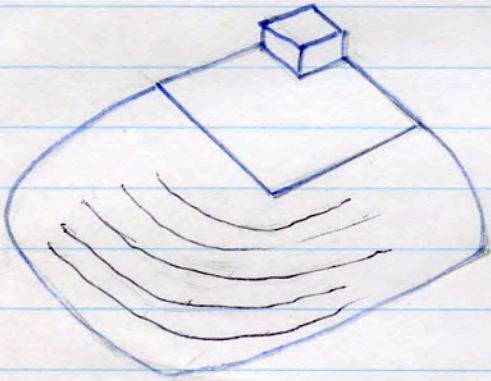

2805

No name, dec TC string course
no panels.

12 lbs.

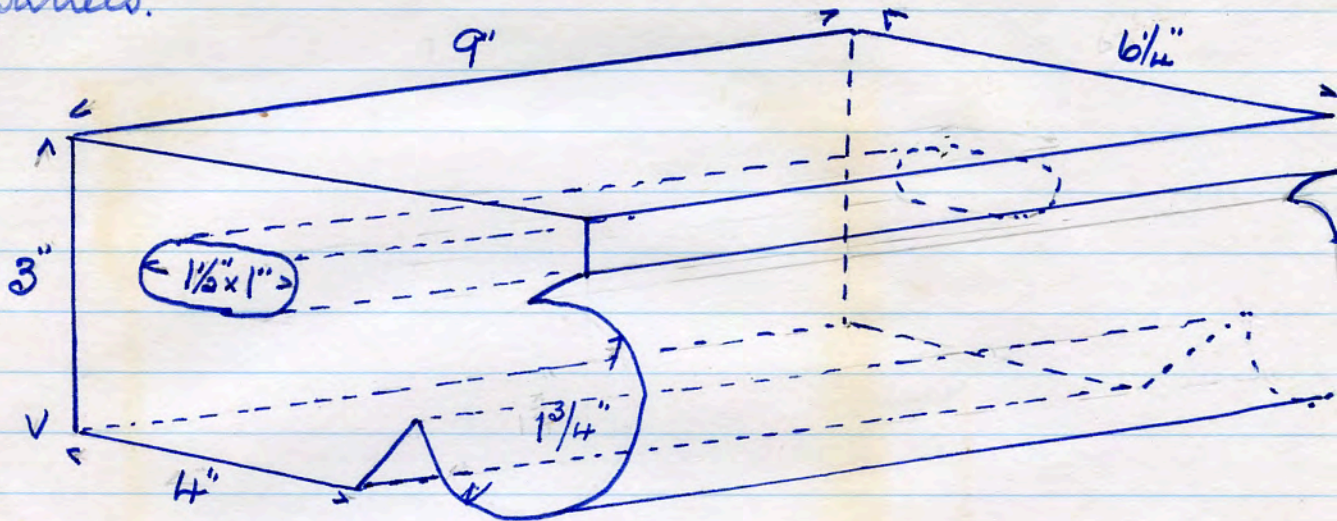

2812

Kay St, off Bridge St, Besham, Bury, 25. 4. 82.

No name. Ruabon trade mark. 11 lbs.

TC dec string course. panel 6 1/2" x 2 5/8" x 3/4"

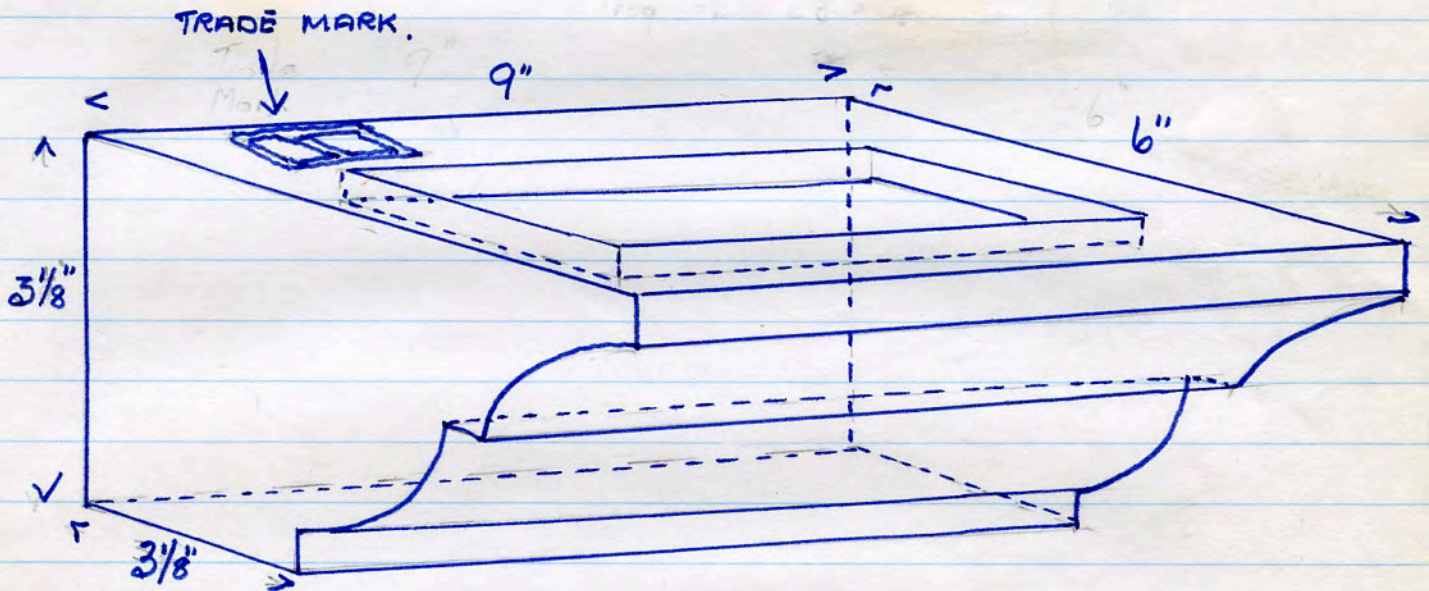

200
2813.

Kay St, off Bridge St, Besham, Bury, 25. 4. 82.

No name, hard burnt, blue wall cap.

no panels. salt glazed fire clay.

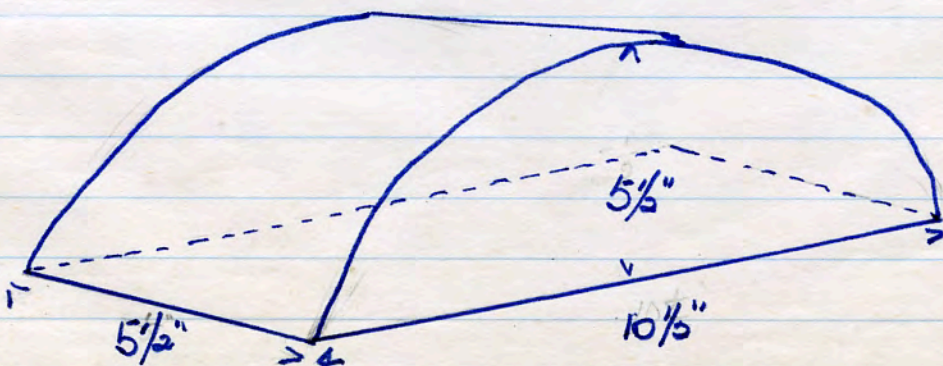

2814

No name. T. C ventilator

4 1/2 lbs. 9" x 6" x 2 1/4"

2815

2H x 1/8" x 1/2" perfs. (4x4) Llanberne St dem. Preston H. H. '82

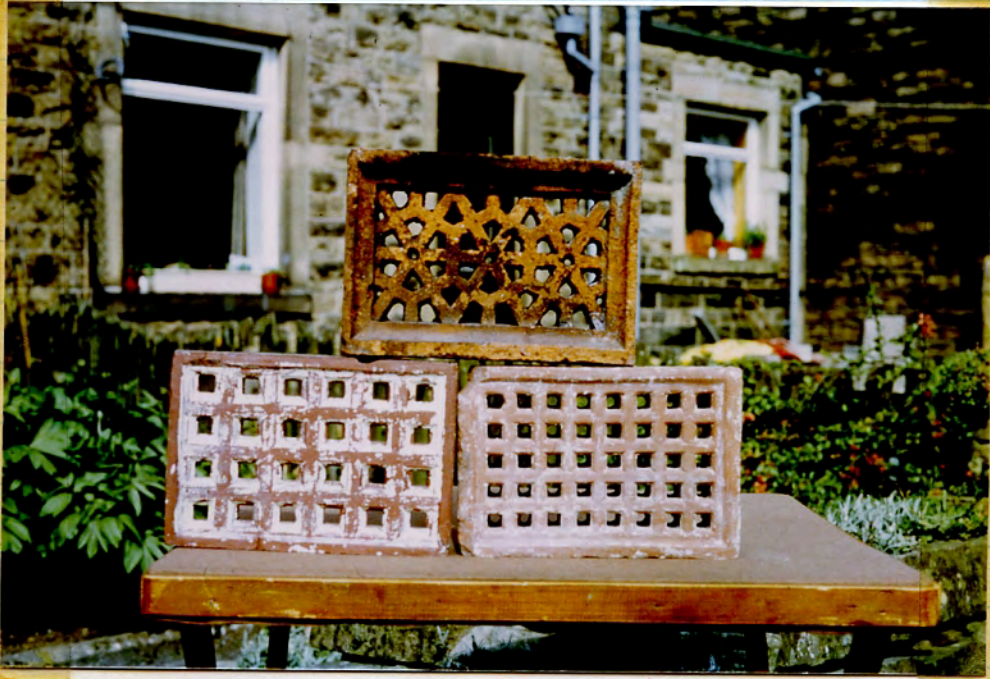

← 2817.

2815.

No name. T. C ventilator

↑ 2816

4 1/2 lbs. 8 3/4" x 6" x 2"

2816.

4H x 3/8" x 3/8" perfs. (8x5) Llanberne St. dem. Preston H. H. 82

No name, clay (pressed) patterned ventilator.
4 lbs. $9\frac{1}{16}$ " x $6\frac{3}{8}$ " x 3"

2817 Back Horn by St West, (house dem) Bury. 25. H. 82.
see photograph overleaf.

No name, cast clay, dec. boss (part) pattern 1" relief
square is 3" thick.

2818 $2\frac{1}{2}$ lbs (part). $6\frac{3}{4}$ " x $6\frac{3}{4}$ " x 3".
Lucas St, Bury - brick dump 25. H. 82.

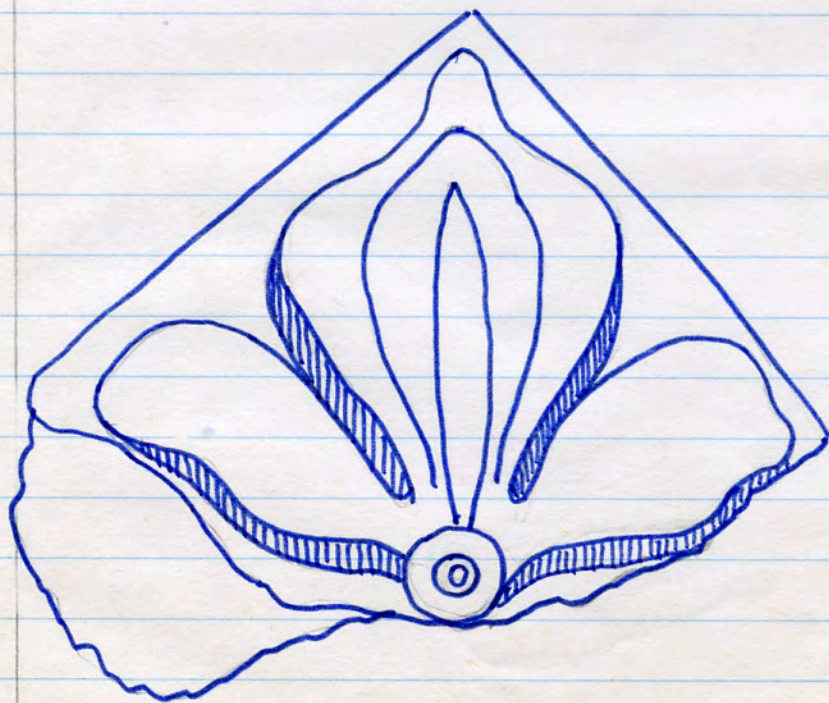

Dennis Ruabon.

7 lbs. R584

2831

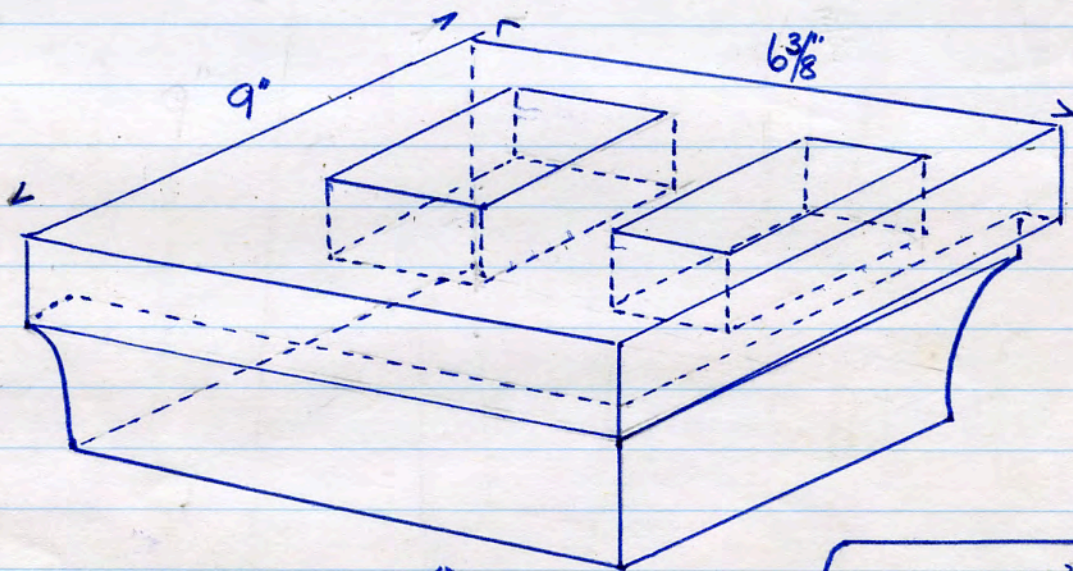
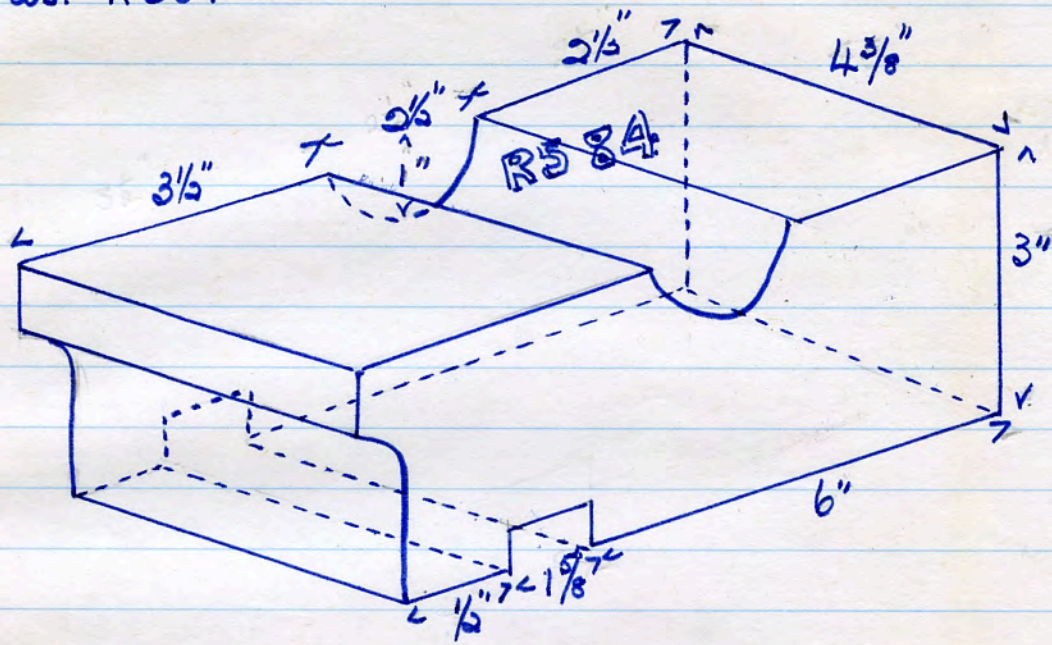

2832.

8 lbs R579 

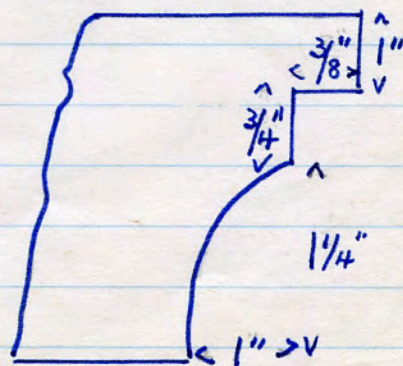

2833 7 lbs

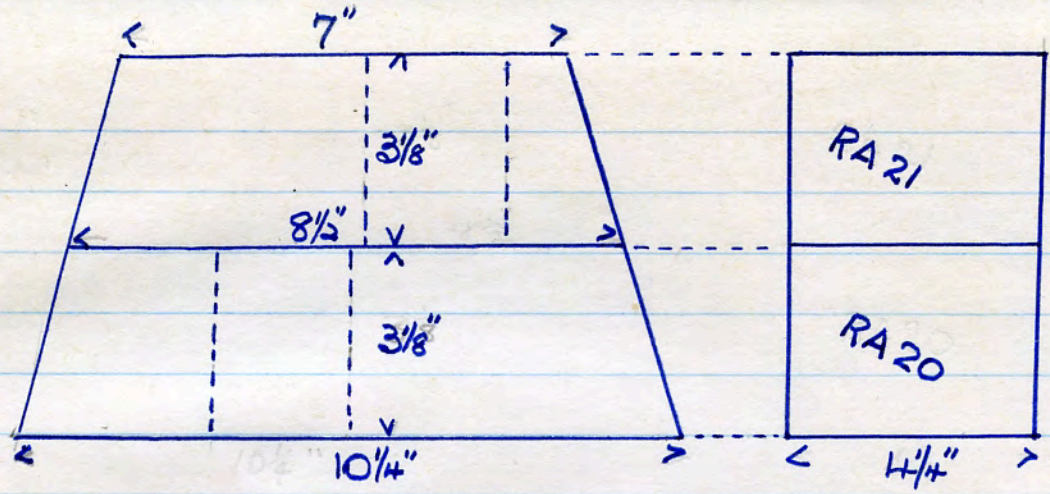

2834 9 lbs

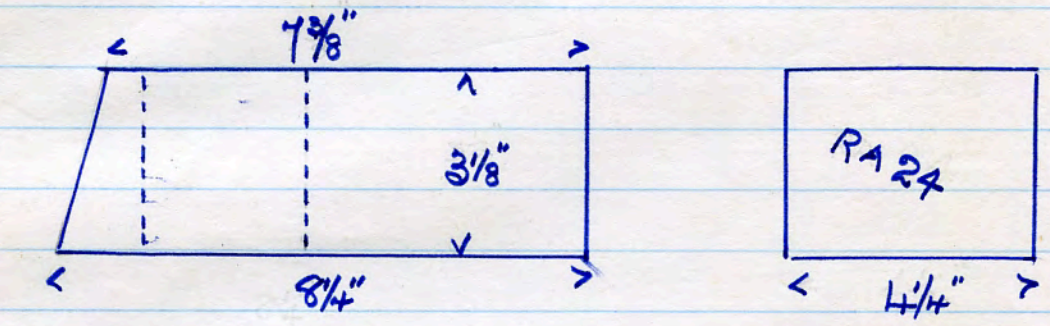

2835 6 lbs

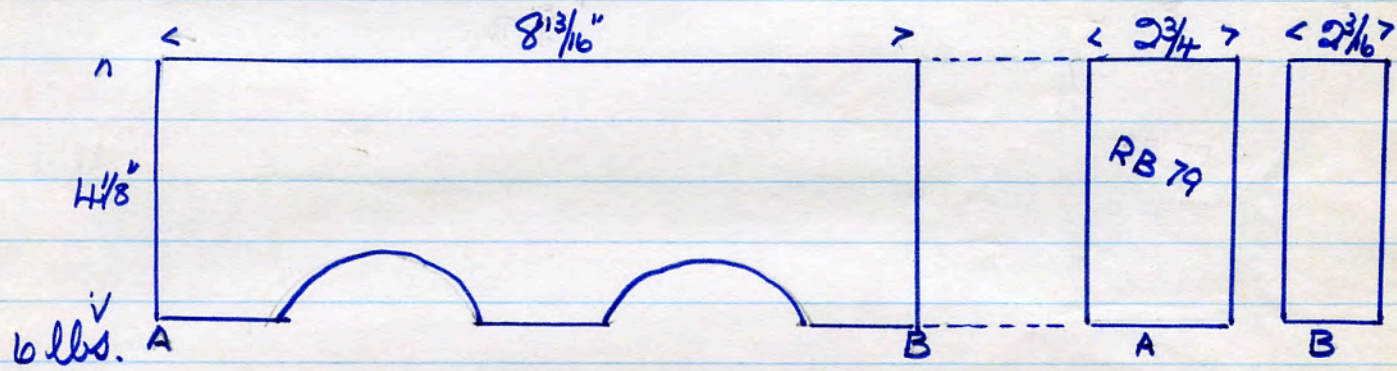

2836 6 lbs

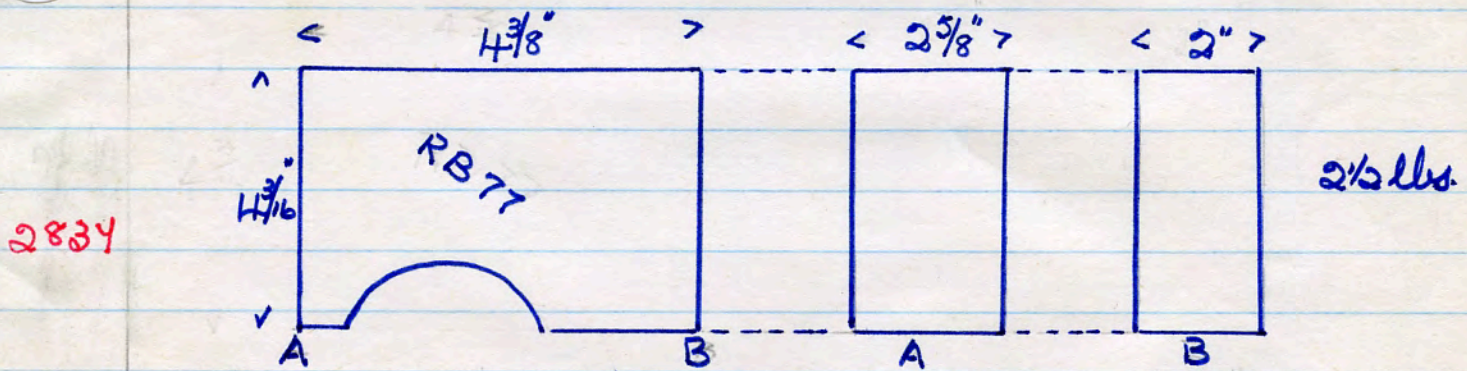

2837 2 1/2 lbs

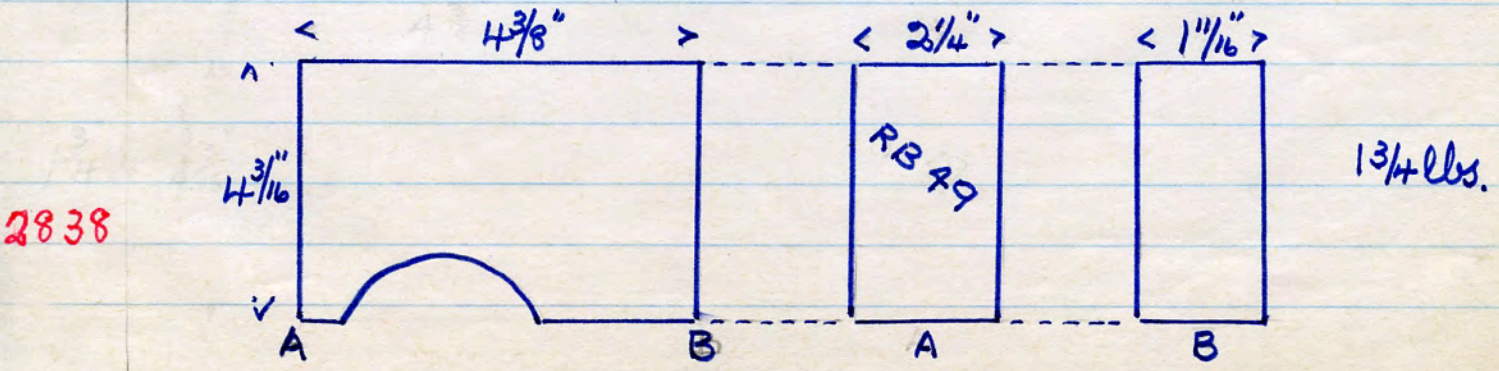

2838 1 3/4 lbs

2839

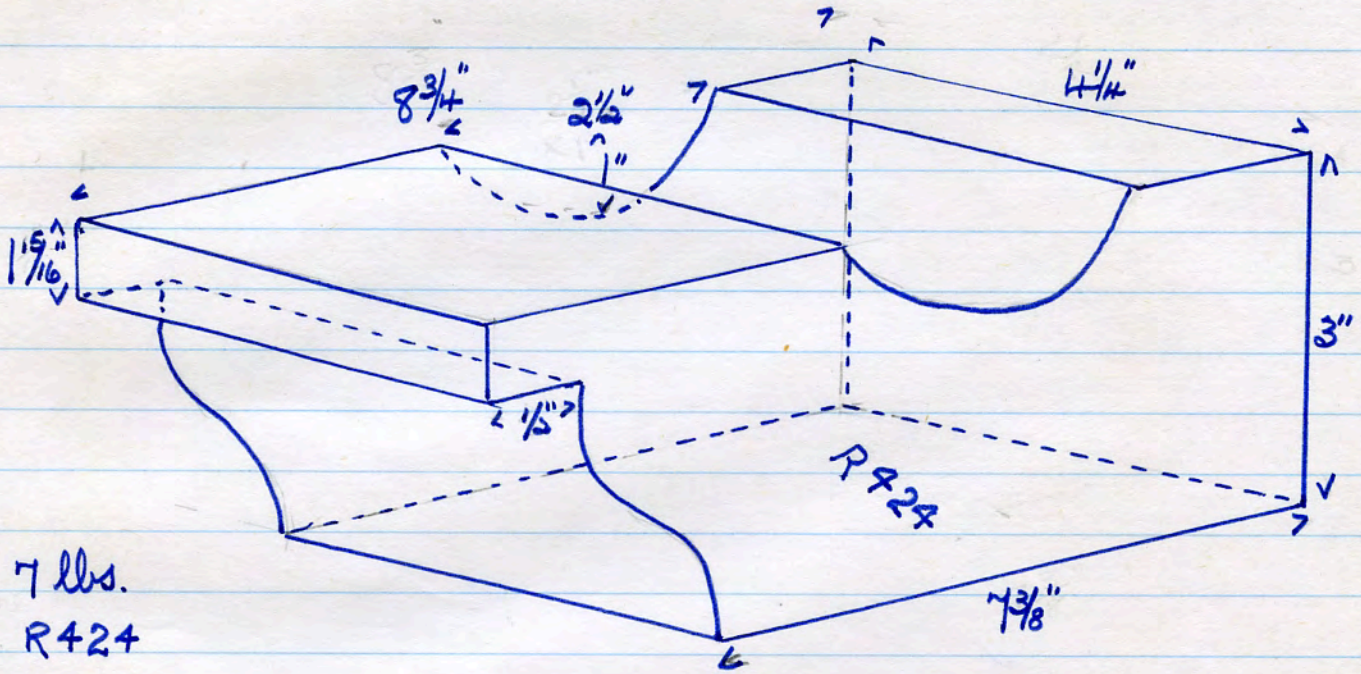

7 lbs.
R 424

2840

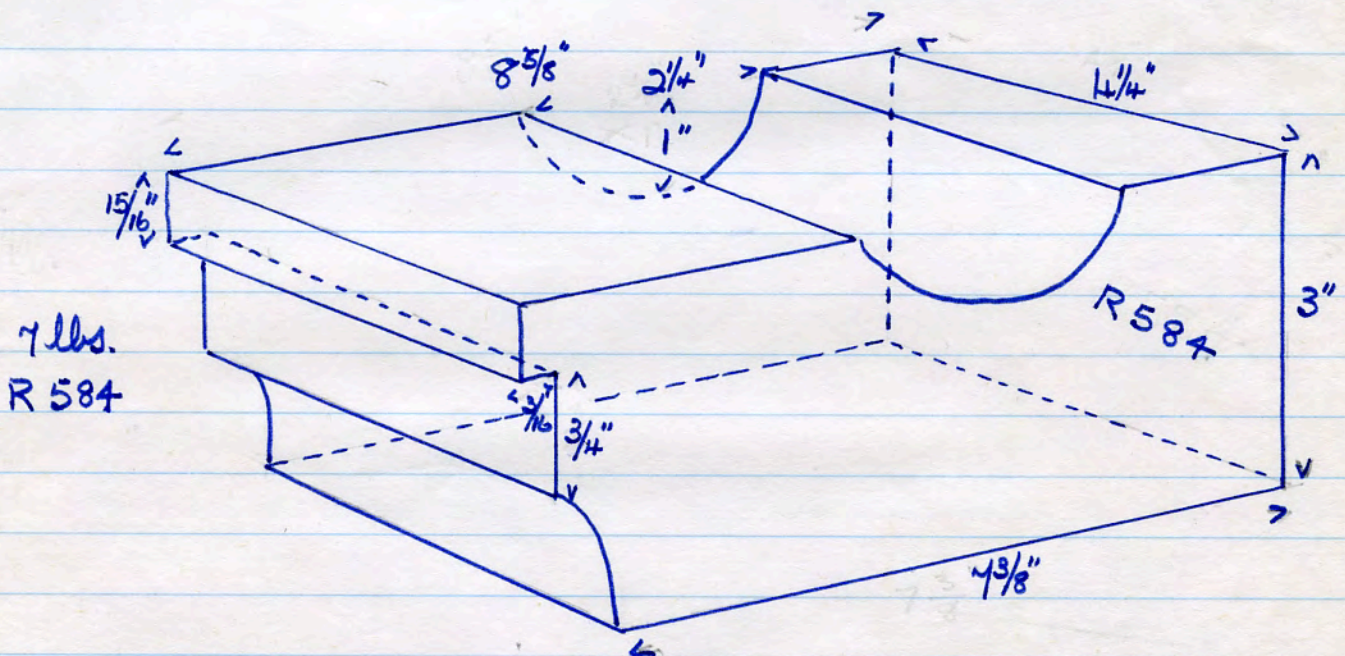

7 lbs.
R 584

48 lbs.

R 91 \square

2841

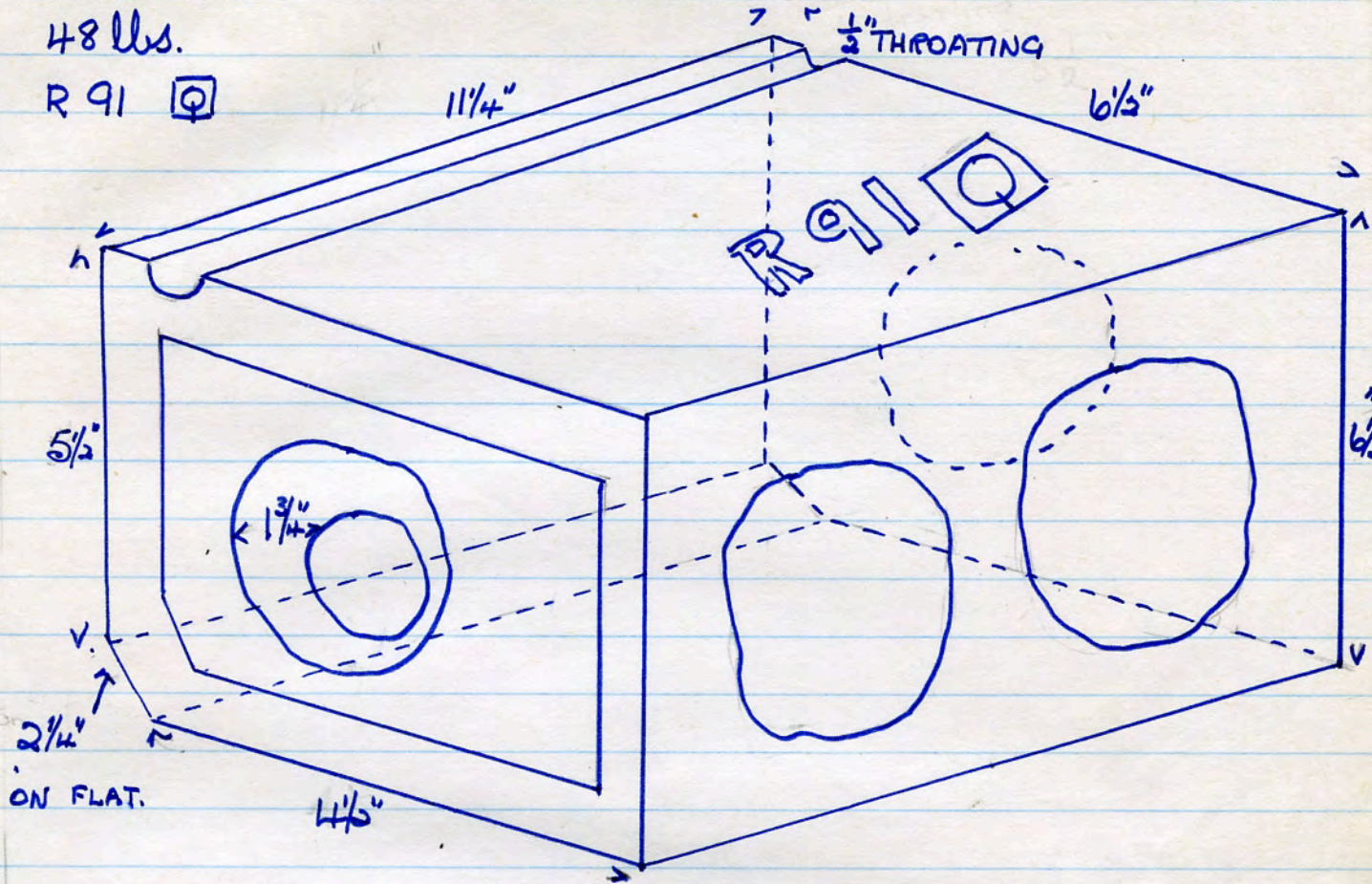

2842

7 lbs

R H 3

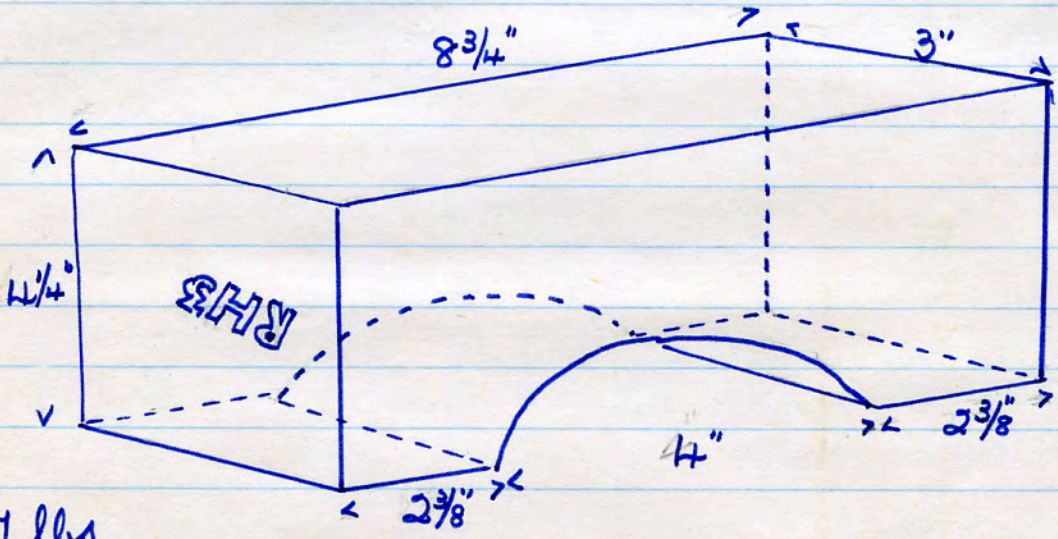

7 lbs
RB57

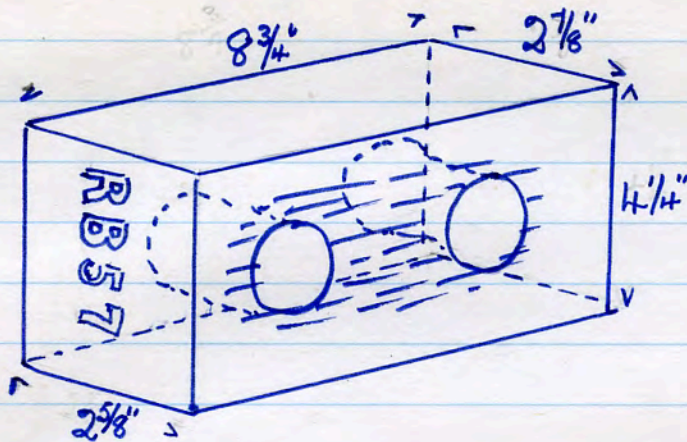

hand scraped panel.
each side

DENNIS RUABON obv. 3 1/8 rev.

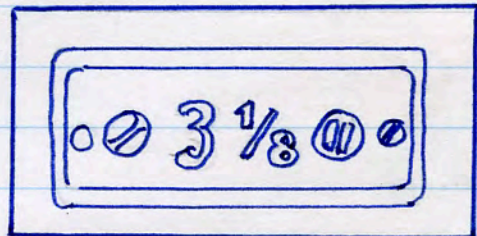
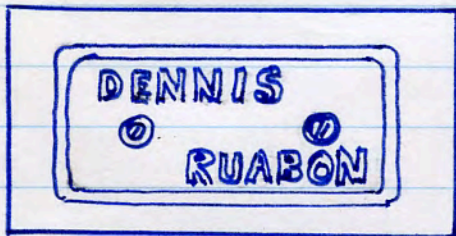

9 lbs. 9" x 4 1/2" x 3 1/8"
single panel each side, letters incised.

Specimens numbered 2831 - 2845, buff T.C.
manufactured by Dennis. Ruabon, and came
from the demolition of Ross Spinning Mill, Bacup
May 1982.



Buff T.C. stop end
kneeler
Ross Mill dem.
(too large to bring
away.)

DENNIS RUABON

R288 buff T.C. wall capping.
Ross Mill dem. Backup. May 1982.
61 lbs

2845

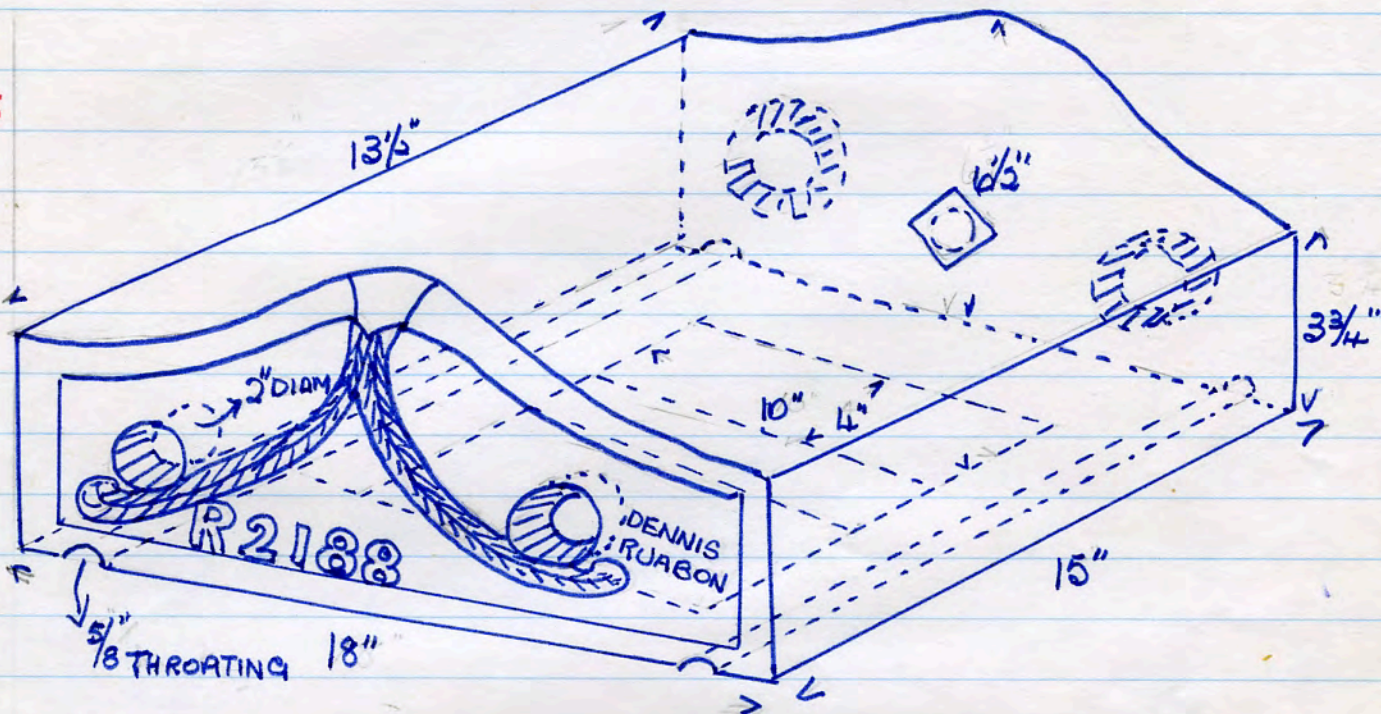

HAND SCRAPED PANELS

2846

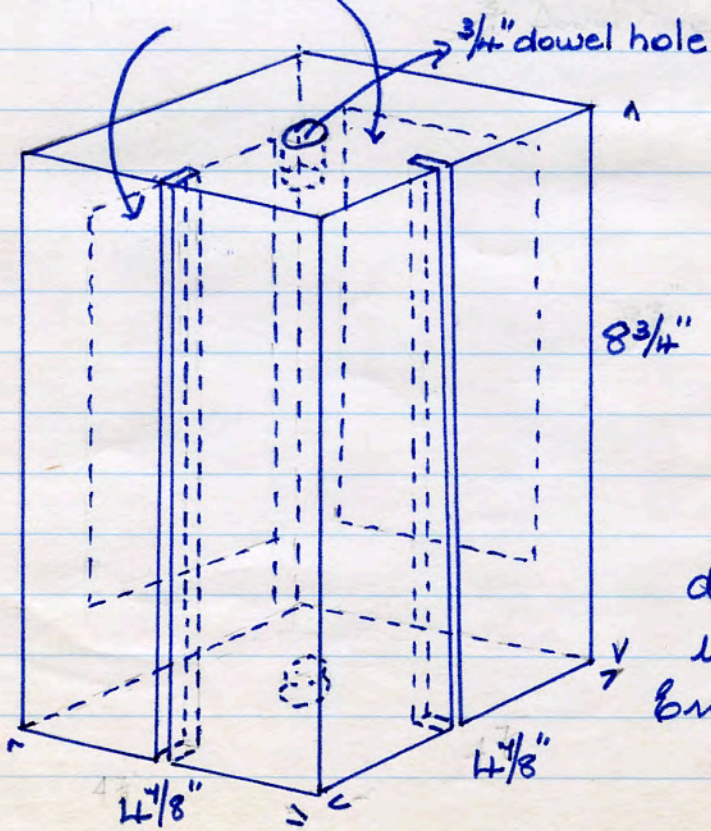

15-5-82.
dec T. O red
use unknown.
Brfield Wks. Display
16 lbs. (1935)

③ stamped on 1" HOLES FOR CIRCULAR IRON ROD.

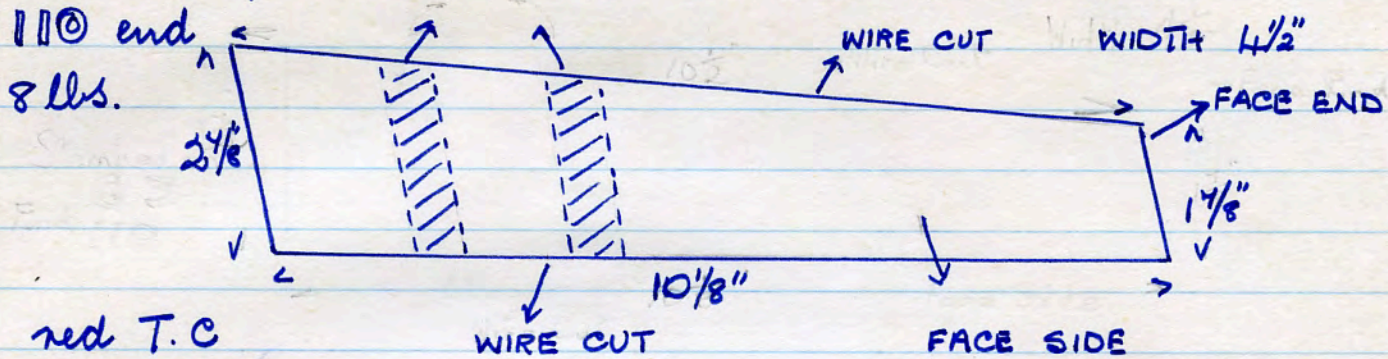

red T.C

2847

wire cut

2848

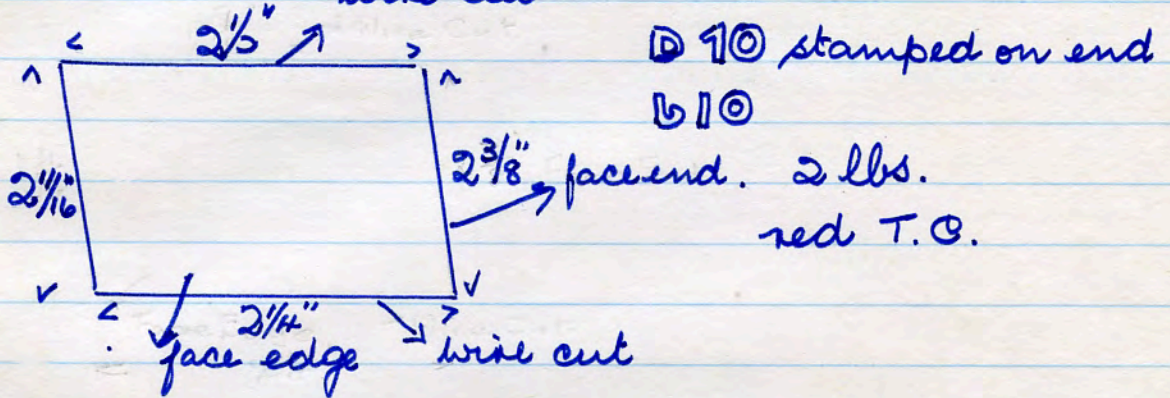

2849

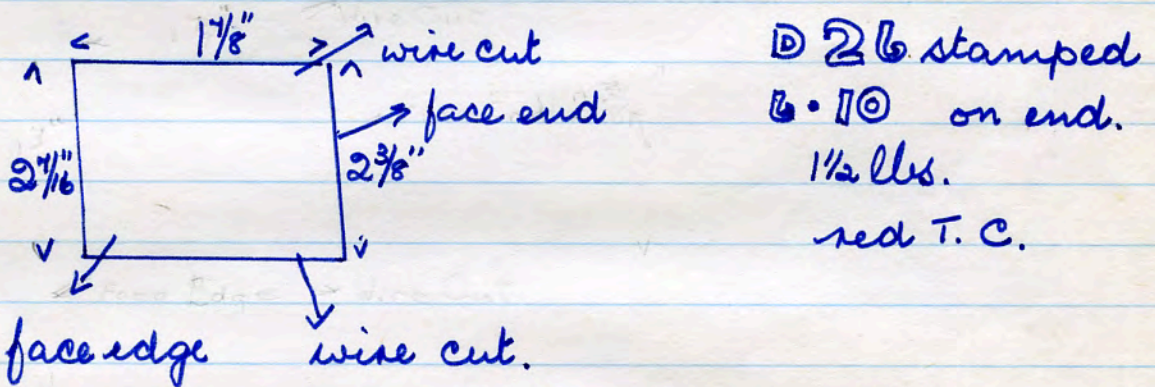

Specimens numbered 2846 - 2849, 2850 - 2852.
red T.C. from Enfield Bats Wks, Deerplay. May '82.

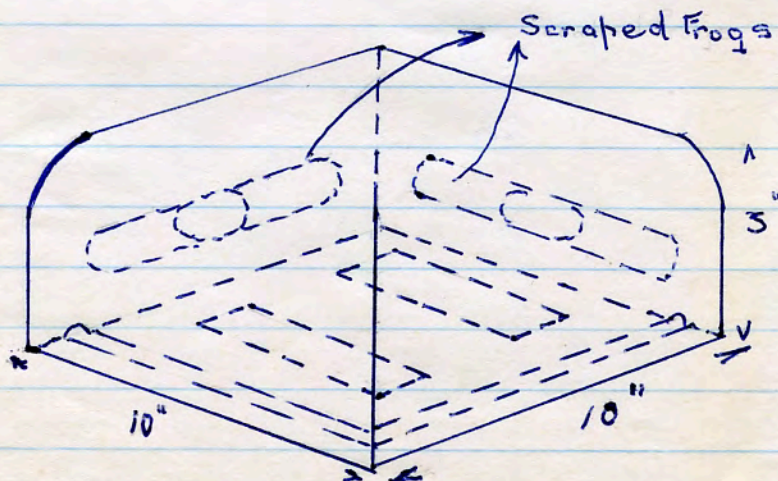

18 lbs

2850

red wall cap return.

No name. red floor tile

15 lbs. $9\frac{1}{4}'' \times 9\frac{1}{4}'' \times 2\frac{1}{2}''$

2859

4 dec panels $3\frac{3}{8}'' \times 3\frac{3}{8}'' \times \frac{1}{2}''$ rev.

plain obv.

Peel Brow, Ramsbottom.

28. 5. '80.

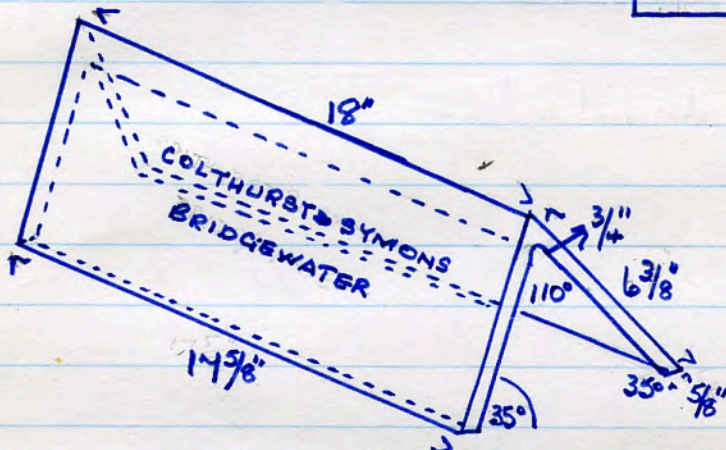
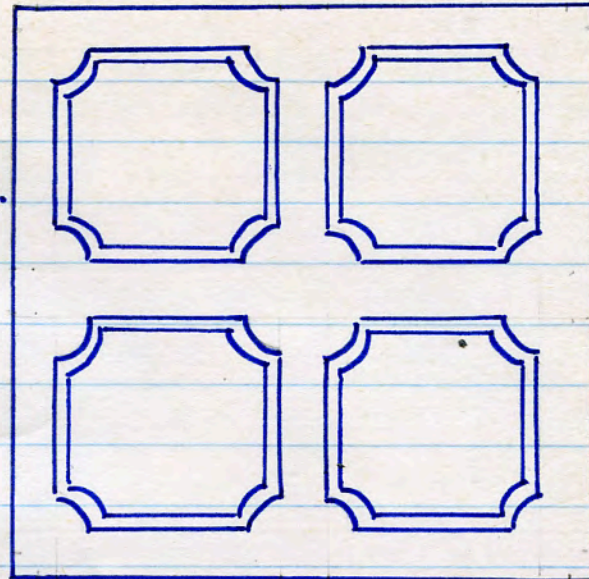

Red slay ridge tile

7 lbs.

Vincent Mader-

Bristol. 12. 7. '82

2900

COLTHURST & SYMONS BRIDGEWATER stamped 1 side

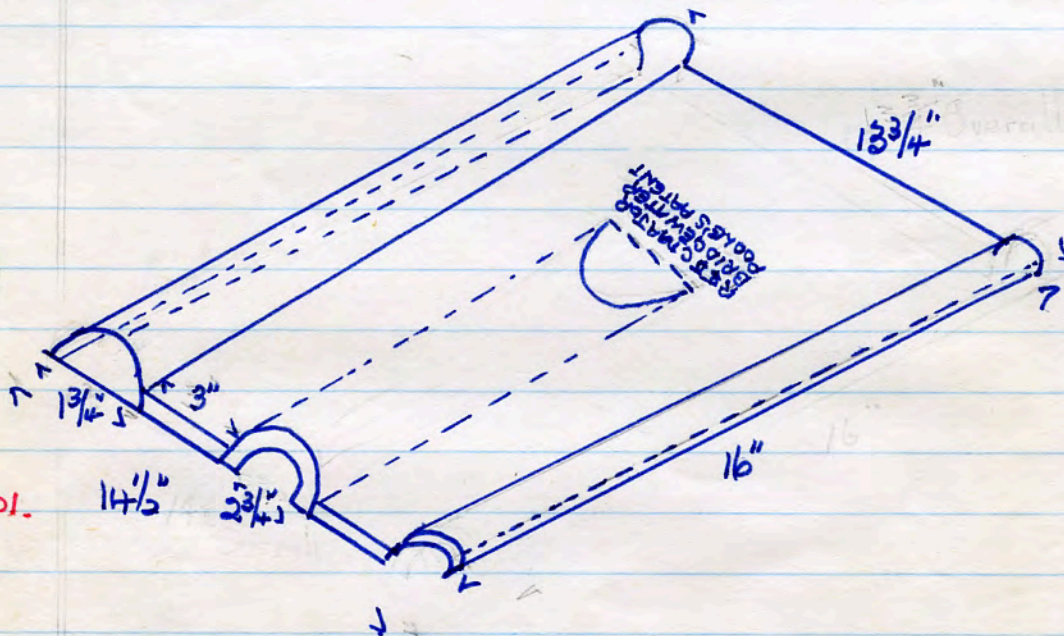

2901.

R J & C MAJOR BRIDGEWATER POOLE'S PATENT

red slay roof tile 8 lbs stamped on face.

Vincent Mader. Bristol 12. 7. 80.

2851

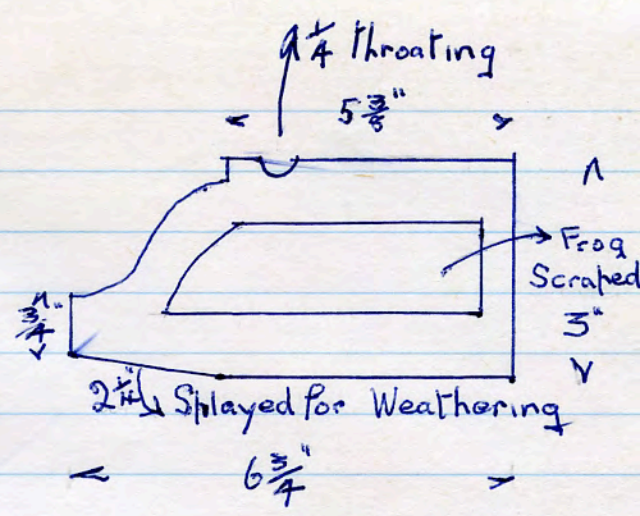
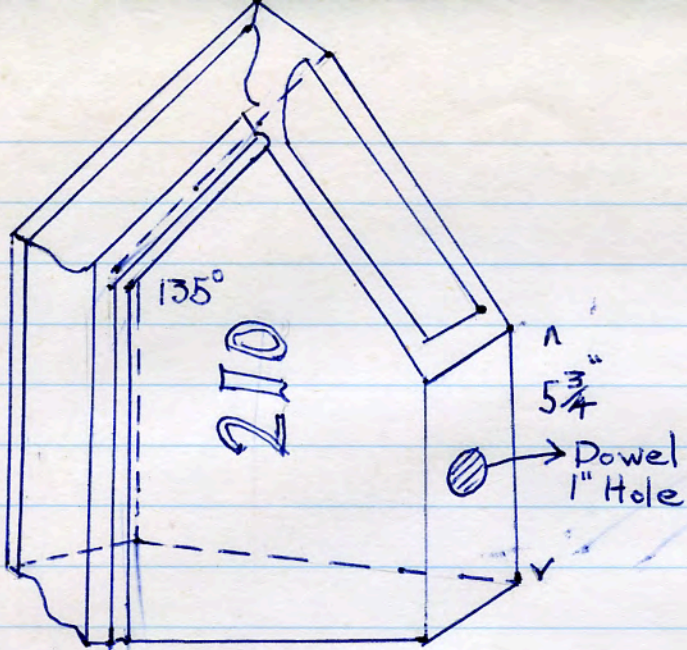

red T.C. return mould. 11 lbs.

2852

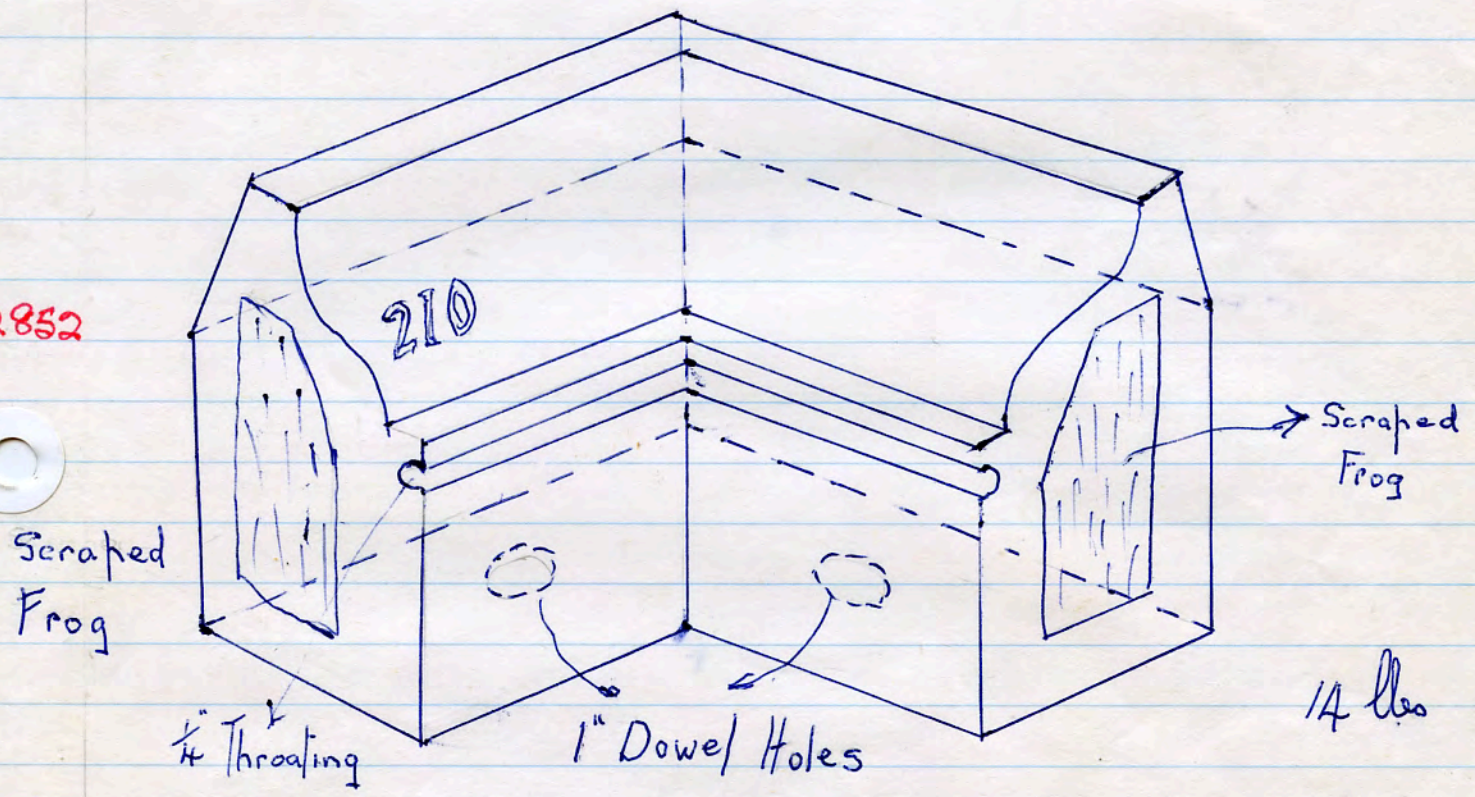

red T.C. return mould (aprow) for window.

2853

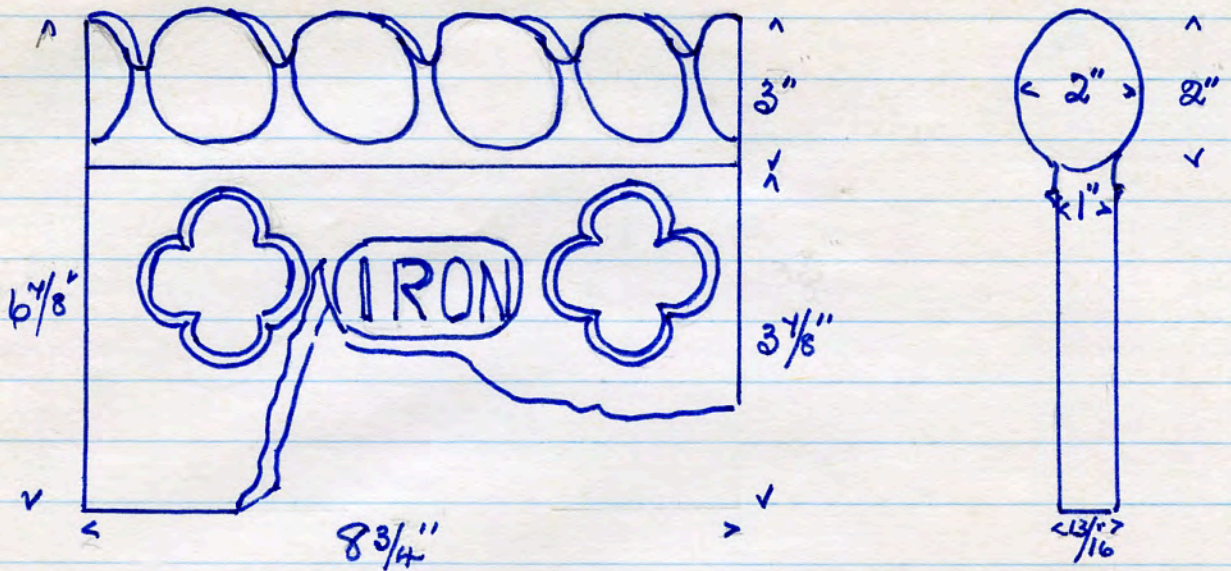

IRON. blue garden edge tile (broken) 3 1/2 lbs.
 3 small dec. panels 1 side only
 letters in relief.

2854

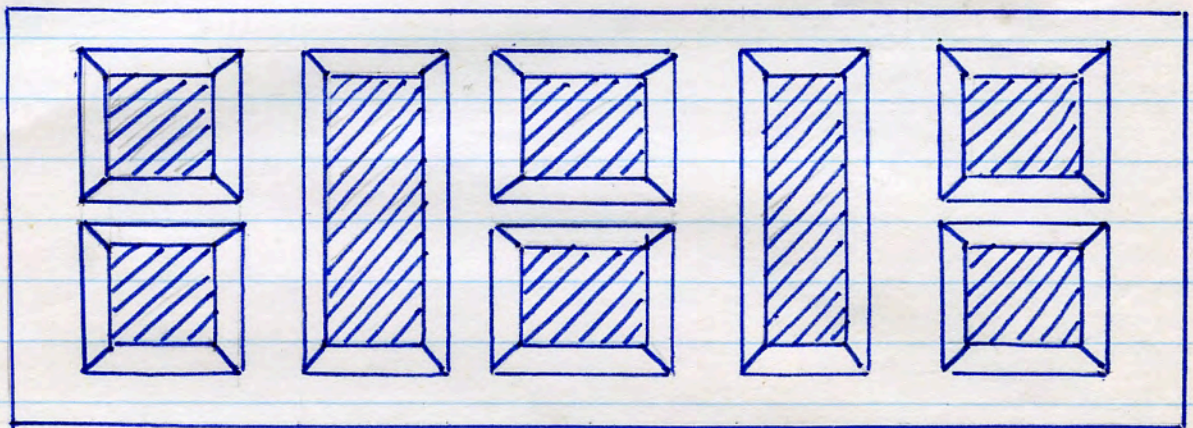

no name (Duckett's dem, Blannel St. Burnley)
 salt glazed, fire clay, ventilator. 19. 5. '80
 4 3/4 lbs. 9" x 3" x 2 5/8"

No name - salt glazed fire clay wall capping.
 49 lbs. 18" x 12 1/2" x 5".
 House dem. Banford Rd.
 Heywood. 27. 5. 82.

2856

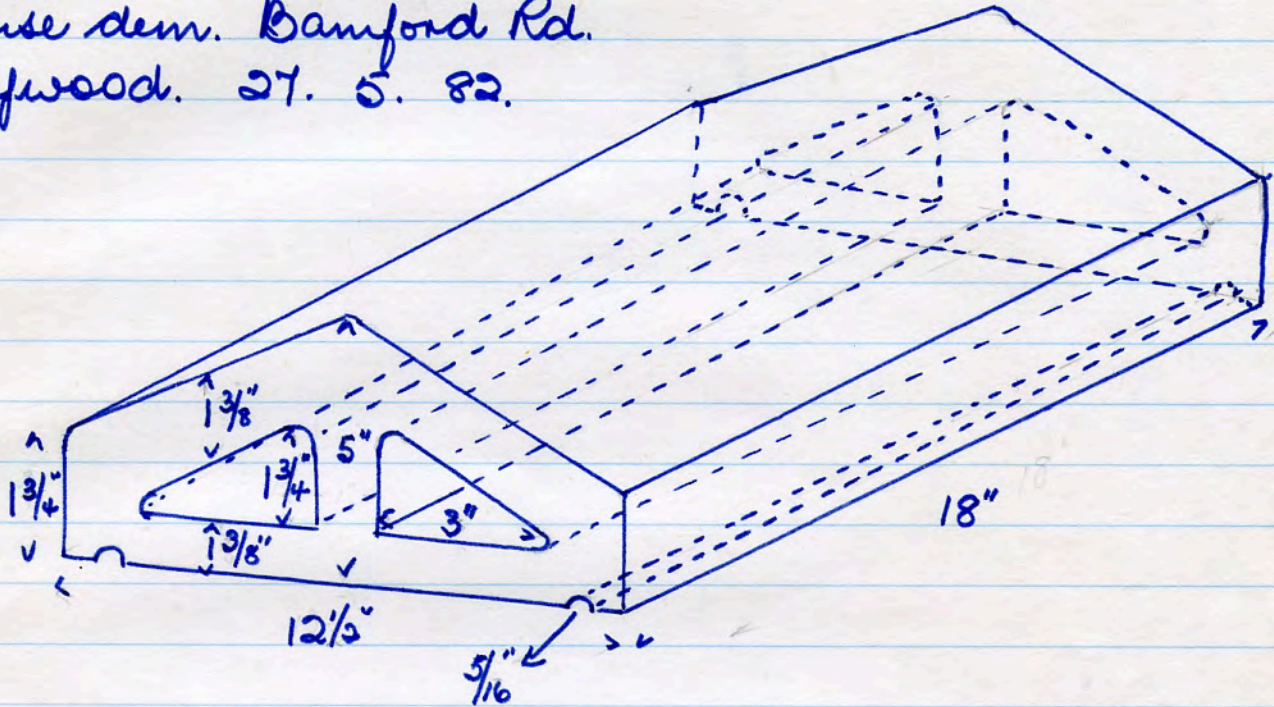

CADDICK. blue ridge tile
 15 lbs. 19 1/4" x
 single panel obv.

2857.

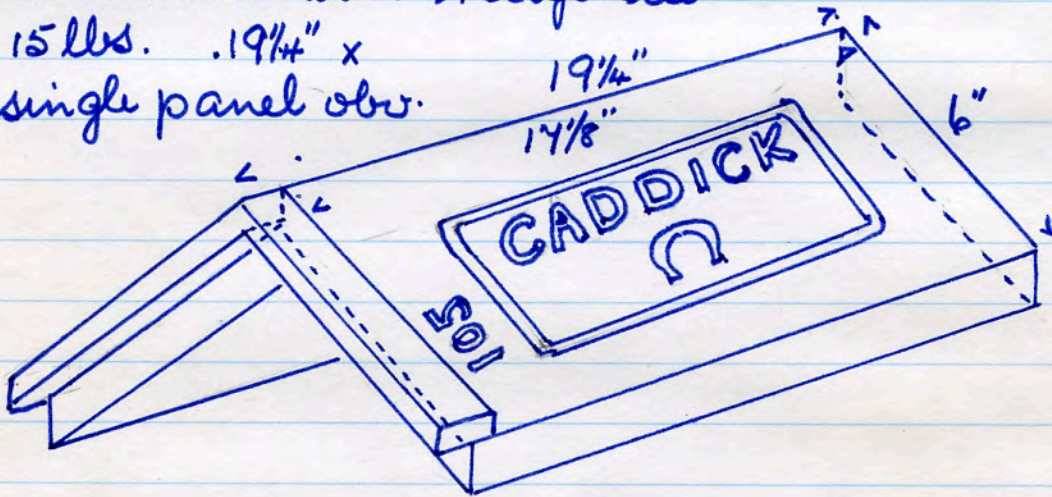

contained angle 115°.
 letters incised. nos 105 incised on inside
 House dem. Banford Rd. Heywood. 27. 5. '82

MTT

2861

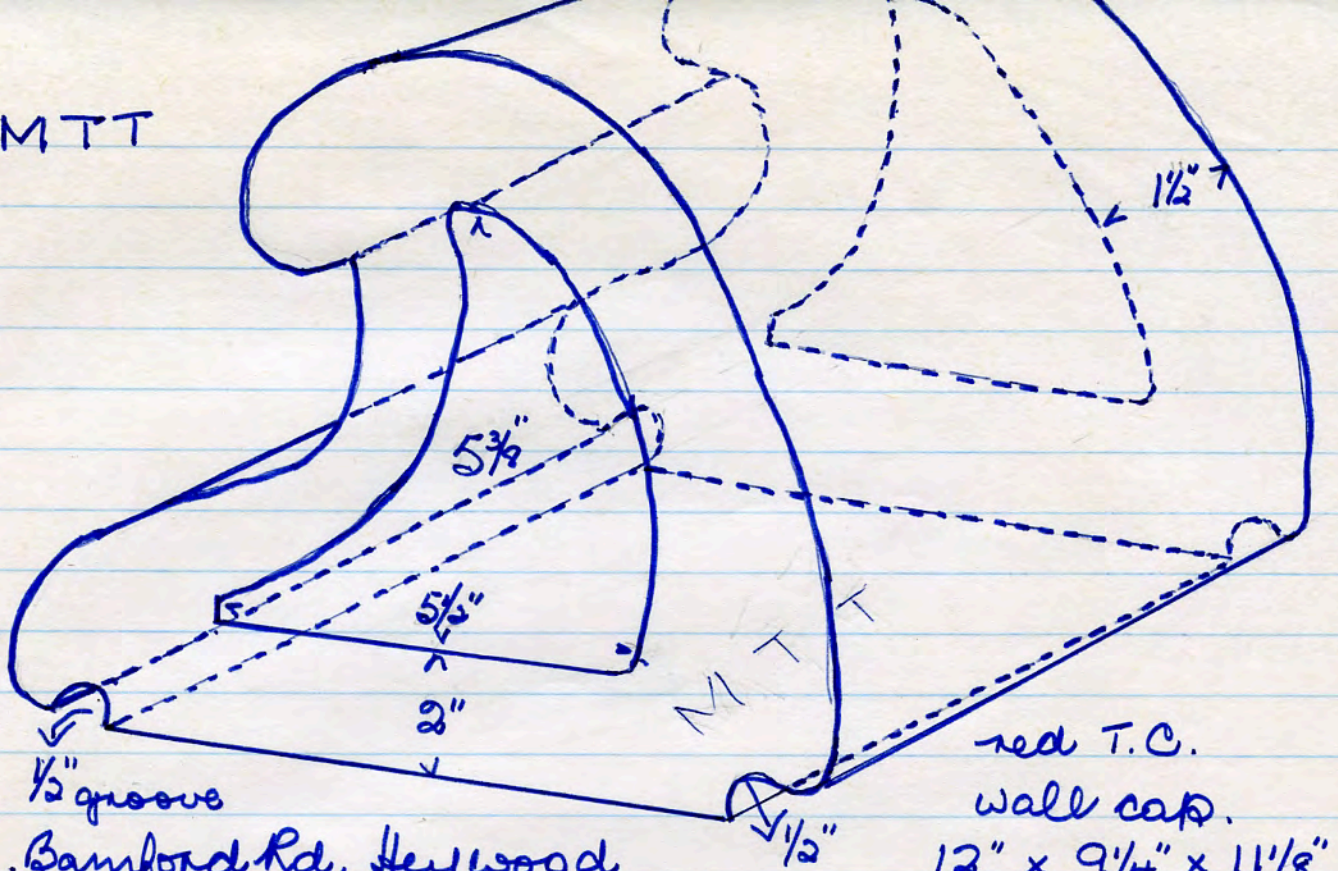

1/2" groove
 Bamford Rd. Heywood
 27. 5. 82. (house dem).

red T.C.
 wall cap.
 12" x 9 1/4" x 1 1/8"

2862.

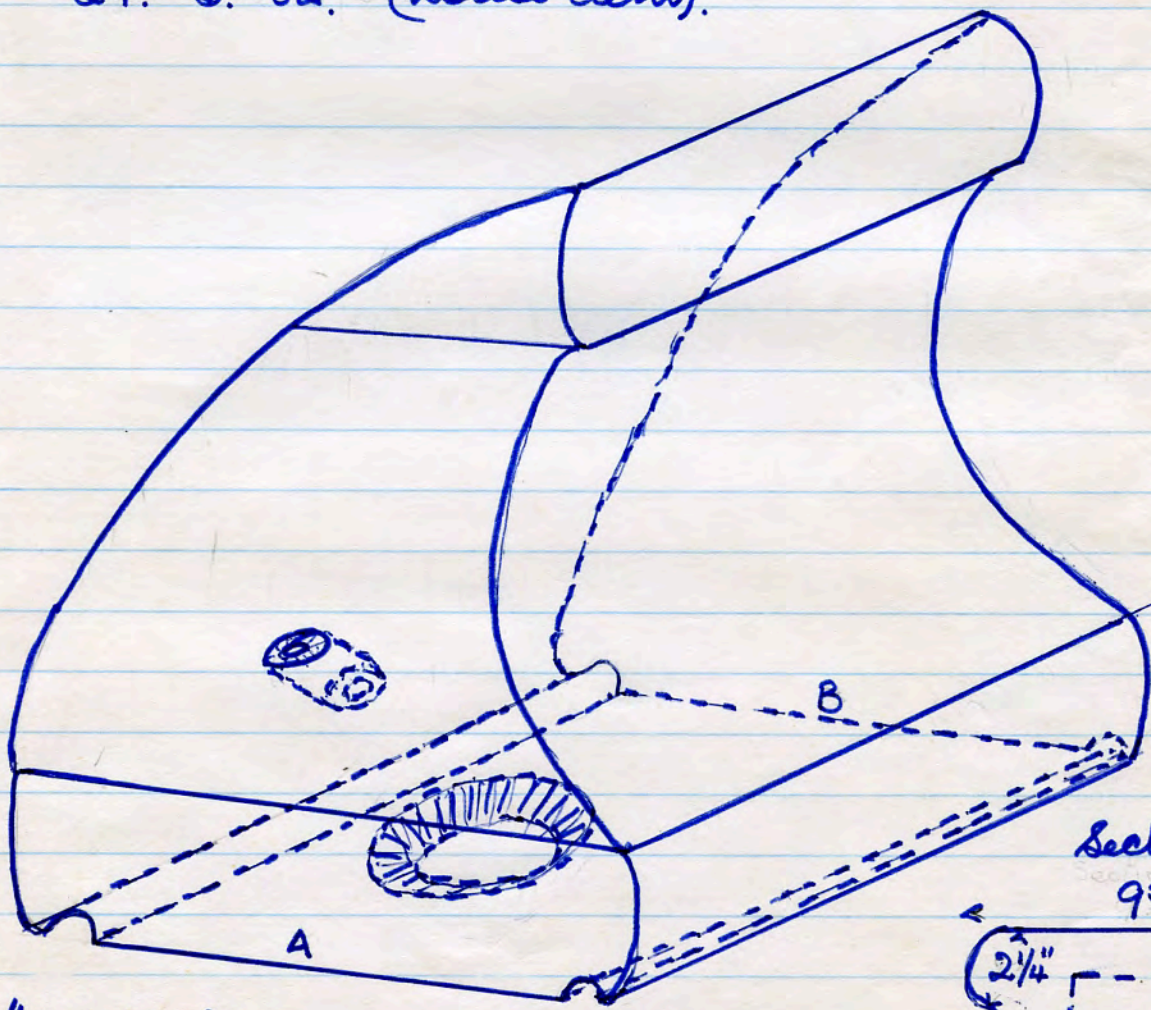

No name
 red T.C. wall cap return.
 Bamford Rd. dem. Heywood.
 27. 5. 82.

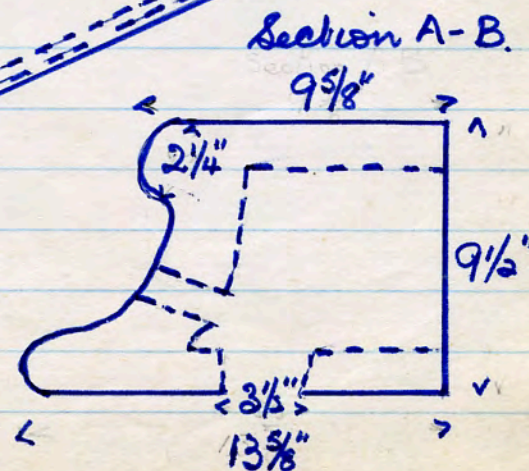

no name. red clay wall cap.
7 lbs. $12'' \times 4\frac{3}{8}'' \times 2\frac{3}{4}''$

no panels. 3 pebbles in mix
2 water drips scratched in

2866.

J. Dibnah. 121 Radcliffe Rd.
Dancy Lever, Bolton. 13. 6. 82.
(late Earl of Bradford's estate).

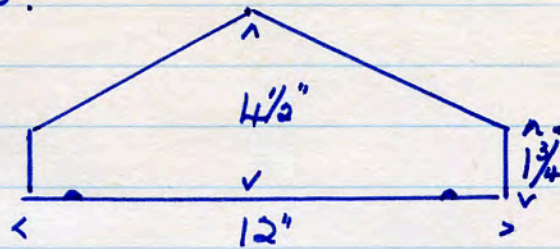

no name, B G A.

red T. C jamb brick. dec.

2867

9 lbs. $9\frac{1}{8}'' \times 4\frac{3}{8}'' \times 3\frac{1}{4}''$

single panel obv. only.

plain rev. - letters stamped.

Hall barr (W. Pundy). 7. 6. 82.

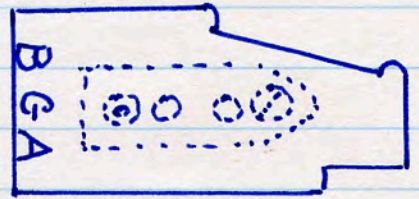

no name. red squint (eng)

9 lbs. $9'' \times 5\frac{3}{4}'' \times 3''$

2868

single panel each side

ex mill chimney. J. Dibnah
(Swan Lane. Bolton?) 13. 6. 82.

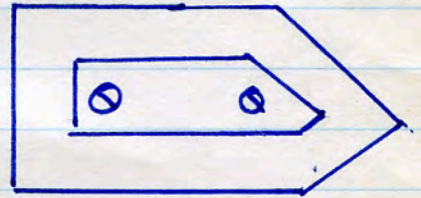

SERMON dec string course, red.

7 lbs. $9'' \times 4\frac{1}{2}'' \times 3''$

single panel rev. only.

2899

letters incised obv "

house dem. Bardsley, Oldham.



E 12 3×6 no name, red, radius stretcher for arch

$22\frac{1}{2}$ lbs. $11\frac{5}{16}'' - 11\frac{3}{8}'' \times 8\frac{3}{8}'' \times 3\frac{3}{8}'' - 3''$

2902.

no panels.

letters and numbers scratched on 1 end.

Bealey Bleach Wks dem. Radcliffe 4. 6. 82.

2903

No name. red chamfered sill
7 lbs $8\frac{7}{8}" \times 4\frac{3}{8}" \times 3\frac{1}{16}"$
 $2" \times \frac{1}{4}"$ centre throating.
no panels.

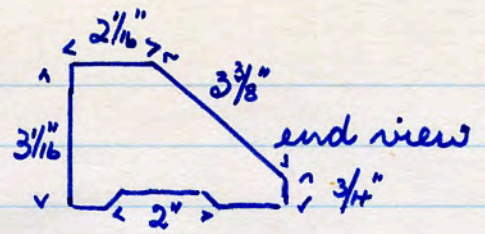

Jandle Hill, Rayton 11. 7. 82.

2904

No name. red chamfered sill
9 1/2 lbs. $9\frac{1}{8}" \times 5\frac{5}{8}" \times 3\frac{3}{16}"$
no panels. centre core $2\frac{7}{8}" \times 1\frac{1}{8}"$
water drip (bull nose).

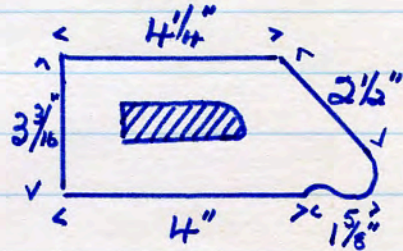

Jandle Hill, Rayton. 11. 7. 82

2905

No name 24. red chamfered sill
8 1/2 lbs. $8\frac{3}{4}" \times 5\frac{1}{2}" \times 2\frac{3}{4}"$
no panels, nos stamped 1 end.
centre core $2" \times \frac{3}{8}"$
water drip (bull nose)

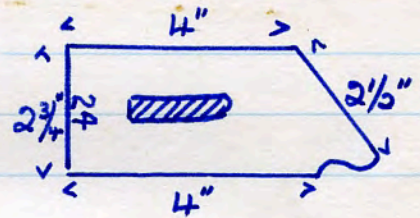

Jandle Hill, Rayton 11. 7. 82

2906

No name. dec fire clay corbel
13 lbs $16\frac{3}{4}" \times 6\frac{3}{8}" \times 3"$
panel (single) each side. $9\frac{1}{2}" \times 3\frac{3}{4}"$
Railway St shop dem. Melson 1. 7. 82.

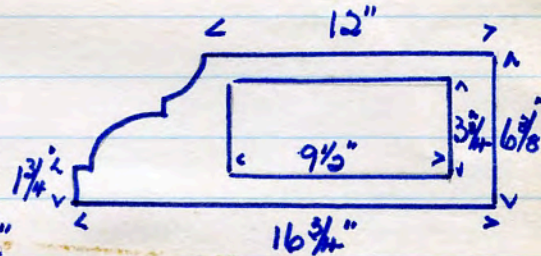

2907

No name, red T.C wall cap.
17 lbs. $11\frac{7}{8}" \times 6" \times 11\frac{3}{8}"$ (length).
no panels, square core in base $4\frac{1}{4}"$.
water drip each side

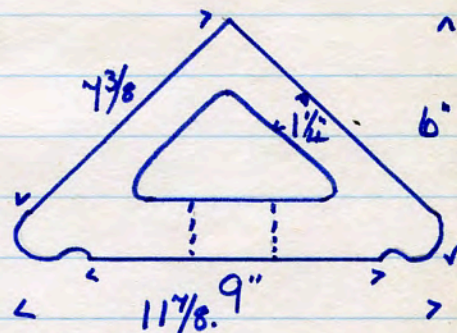

Bealey Bleach Wks dem. Radcliffe 4. 7. '82.

no name 6. red TC stretcher, scotia mould.
horizontal groove in lieu of frog.

2933

12 lbs. 9" x 6³/₈" x 3¹/₈"

no panels. 6 stamped on 1 end.

Wesleyan Chapel, Radcliffe Rd,
Radcliffe. 1. 8. 82.

$\leq 1^{\circ} \leq 1/8^{\circ} \leq 2 1/8^{\circ} \leq 4 1/4^{\circ}$

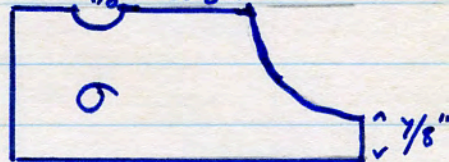

no name. clay hip tile.
Humbesside. Mrs Los.

2942



No name, red ventilator.

11 lbs. $9\frac{1}{4}" \times 6\frac{3}{8}" \times 3\frac{3}{8}"$

2948

flush face. 7×14 perfs. $\frac{7}{8}" \times \frac{7}{8}"$

Tip at New Line End (Holt's Sidings) Bacup. 21. 8. 82.

No name, red ventilator.

2949

6 lbs. $9\frac{1}{8}" \times 3" \times 2\frac{3}{4}"$

flush face. 7×14 perfs. $\frac{7}{8}" \times \frac{7}{8}"$

Tip at New Line End. Bacup. 21. 8. 82.

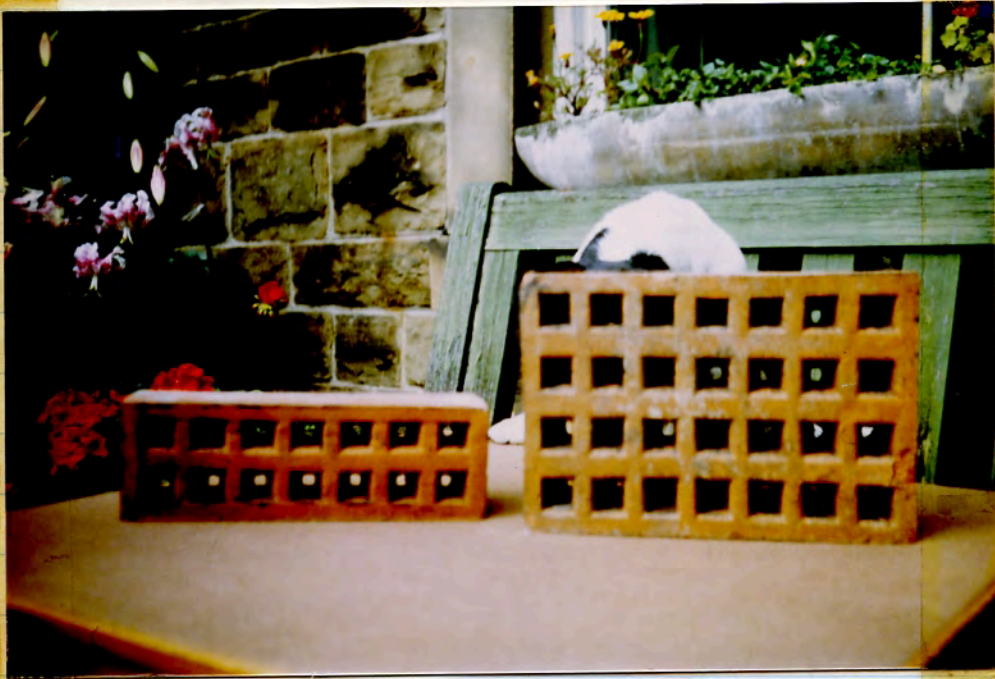

B.B. & T. red. corbel (part).

4 1/2 lbs. 9" (?) x 4" x 3 1/4"

single panel 1 side only.

2954. letters incised.

Railway St. Littleborough. 16. 9. 82.

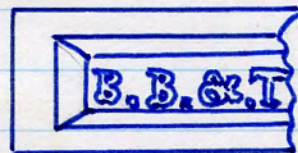
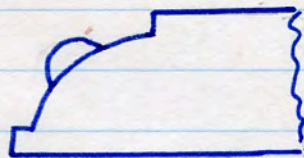

P fire clay ventilator (broken).

4 lbs. 9 1/4" x 3" x 3 1/4"

2955 3 cartwheels in design.

Railway St dem. Nelson. 1. 4. 82.

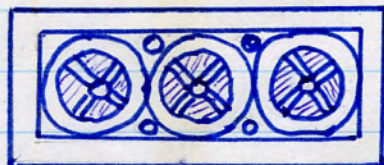

J. C. EDWARDS TERRA COTTA WORKS RUABON N W

decorative T. C. tiles to form panels on outer wall of
warehouse in Long Millgate, Manchester. 9. 11. 80.

2958.



1035 salt glazed fire clay chimney pot, (without top)
nos in relief. 42 lbs. 21 $\frac{1}{4}$ " x 9 $\frac{3}{4}$ " top x 13 $\frac{1}{4}$ " diam. base.
2959 Brankshaw's, Horwich



J⁸⁰¹~~75~~ salt glazed fire clay chimney pot. (complete)
2960. nos in relief. 34 lbs. 19 $\frac{1}{4}$ " x 9 $\frac{1}{2}$ " diam. top x 12 $\frac{1}{4}$ " base.
Brankshaw's Horwich.



2961
single star decoration incised. 31 lbs. 17 $\frac{1}{4}$ " x 11 $\frac{1}{2}$ " top x 13"
No name (Gilbert, Stokes) red clay chimney pot. base
F. Dibnah, Darcy Lever, Bolton.

No name. Decorative T. C. gate pier cap. Red.
H. 7. 83. Bealy Bleach Works dem.

2962



Interior view - hand scraped.

2962



No name. red T. C vent.

2 lbs $8\frac{3}{4}" \times 2\frac{3}{4}" \times 3\frac{1}{8}"$

2964 9 apertures $\frac{1}{2}" \times 1\frac{3}{4}"$

dem. at rear of Drake St. 2. 10. 82.

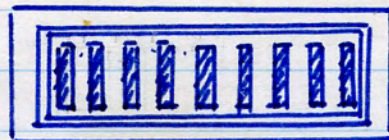

No name. rustic planter in shape of tree trunk

3 limbs & 3 roots. Salt glazed.

12 lbs. 13" high. 4" diam. hole in top.

2969



S. Spencer. Rosendale General Hospital.

W. FLETCHER HORWICH No 221

dec. red T. C. ventilator.

letters stamped in small oval, on 1 side

12 1/2 lbs.

9 3/4" x 9 3/4" x 3"



2970

Beahy Bleach Works dem. 4. 7. 82. Radcliffe



PERFUME BRICK. light red T.C.

1/2 lbs. 2" x 1" x 5/8"

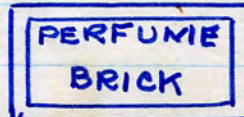

2996

single shallow panel each side
letters incised, both sides alike

Mrs Ros. Woodmasey 15. 5. 83.

BEAMISH rev. butter mould. circular

2997

1 1/4 lbs. 3 1/4" diam. overall thickness 3/8"

circular panel obv. decorated.

in relief - rose, thistle and
shamrock. letters incised (tiny).

Mrs Ros. Woodmasey 15. 5. 83.

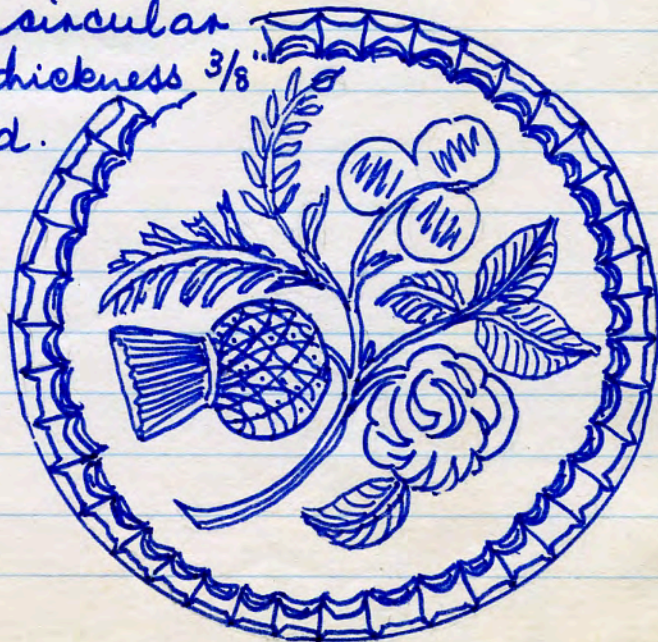

No name. black tile with 2 threads of red in mix
1 lb 1oz. $5\frac{3}{4}" \times 4\frac{9}{8}" \times \frac{7}{16}"$

3009

white glazed letter **T** obv. scored for adhesion. rev.
part of street name - Derby St. Hull 15. 5. 83.



3010.

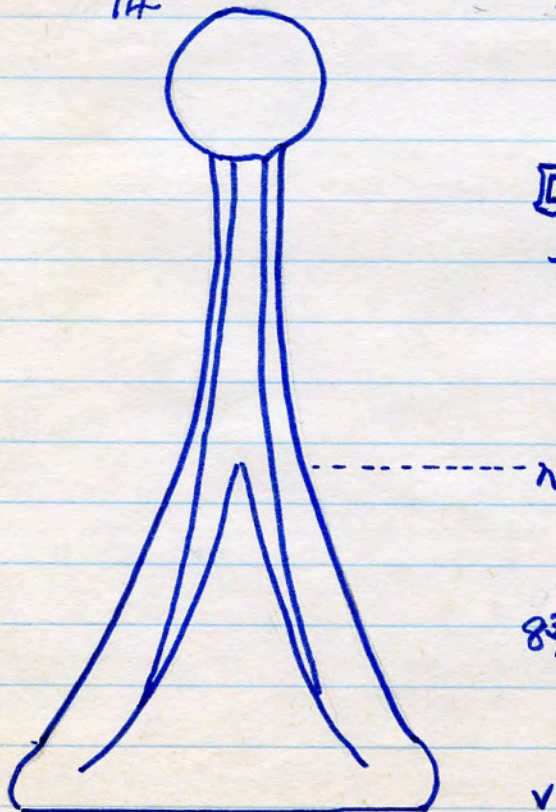
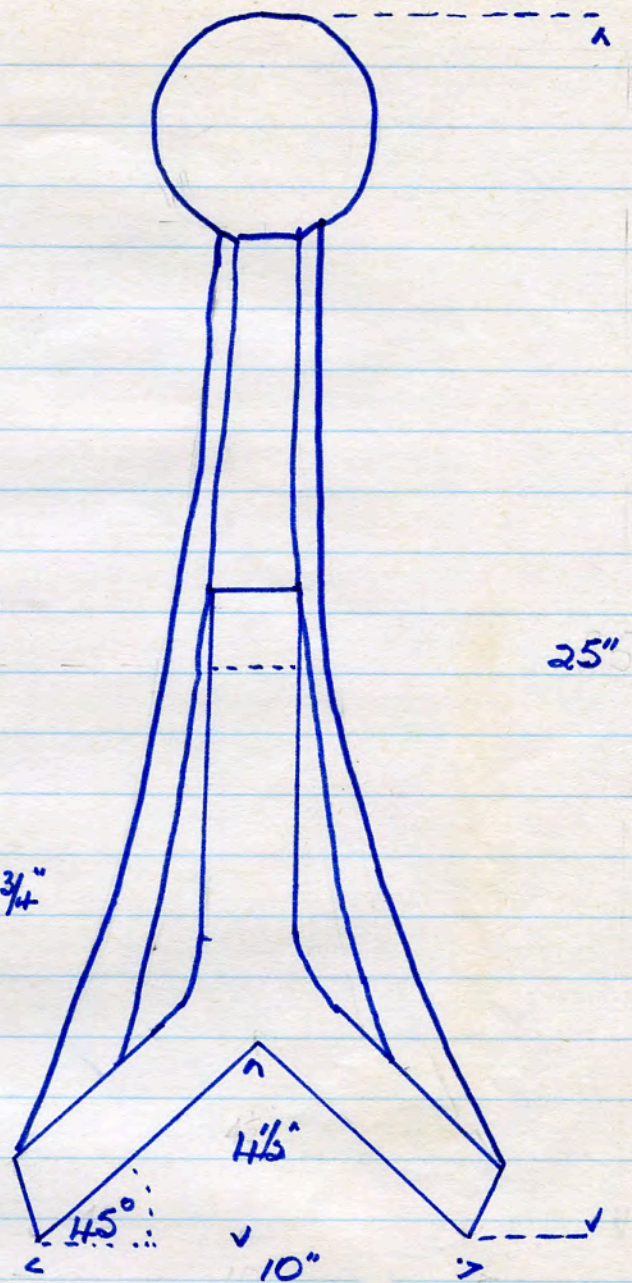
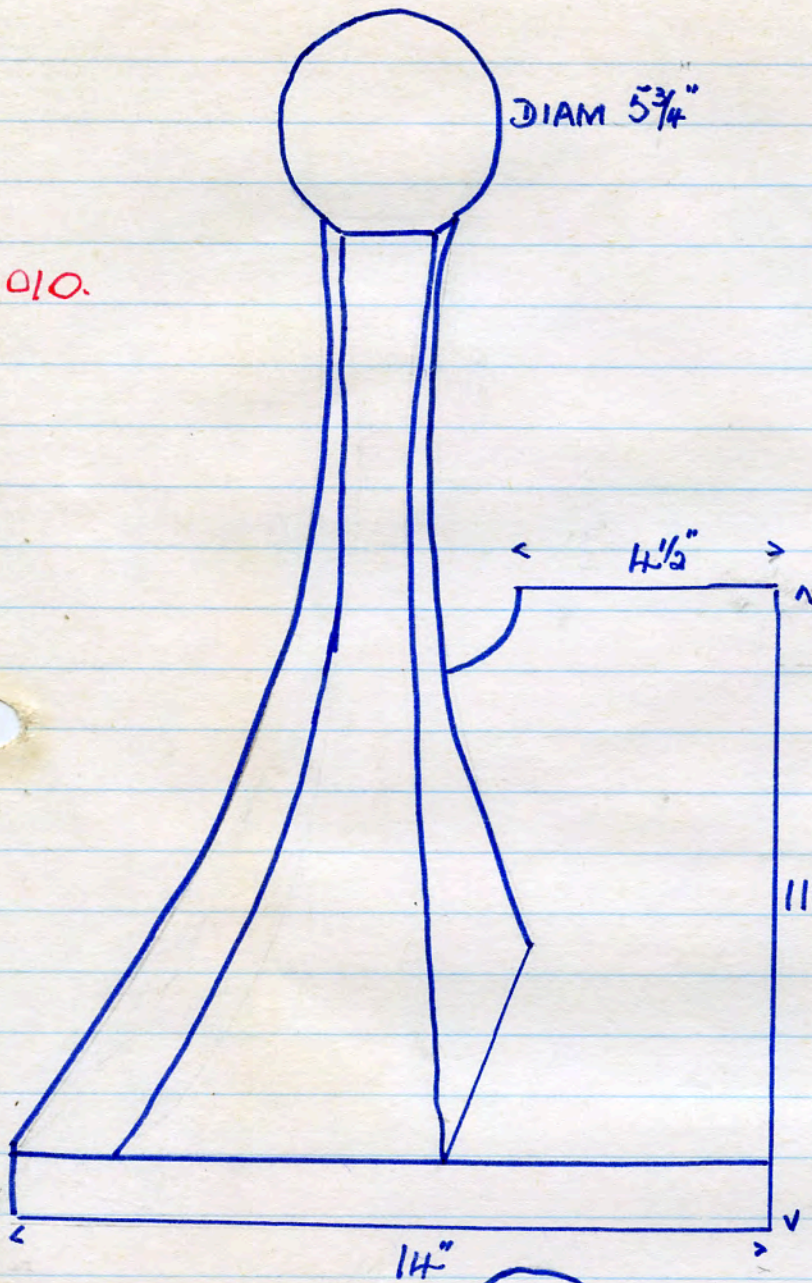

DR (Tennis Racquet) incised red T.C. finish.

35 lbs.

Anchor Inn, Bury Old Rd. Bolton.

13. 5. 83.

AM+I  cream TC

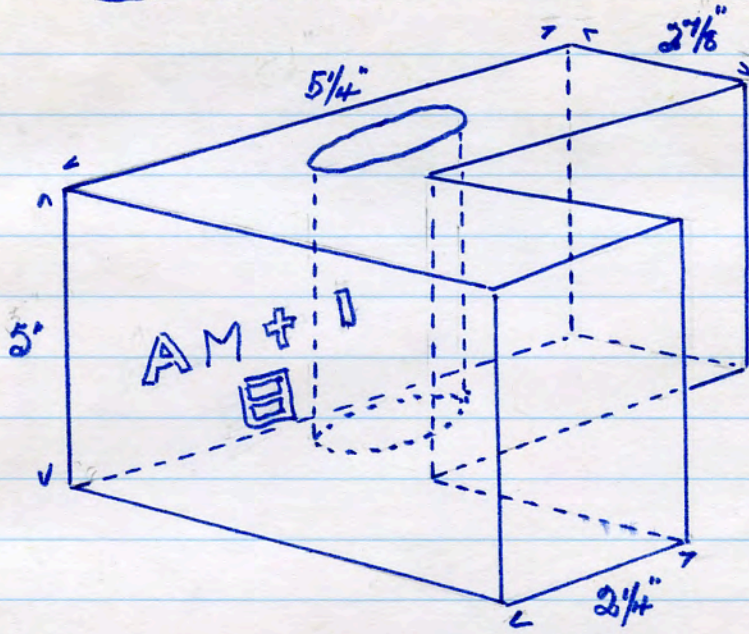

4 3/4 lbs

1 perf. 1 3/4" x 3/4"

Alder Mill dem. Leigh 24. 3. 83.

LNWR dark red wall sapping

10 lbs. 12 5/8" x 6" x 2 1/8"

2 water bars in base.

S. Spencer. Kew Station 15. 4. '83

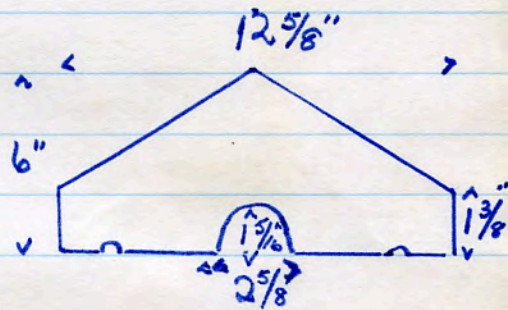

 red T.C ridge tile

18 lbs. 13 3/4" x

letters stamped (faintly). 13. 2. 83.

Anchor Inn. Bury Old Rd. Bolton

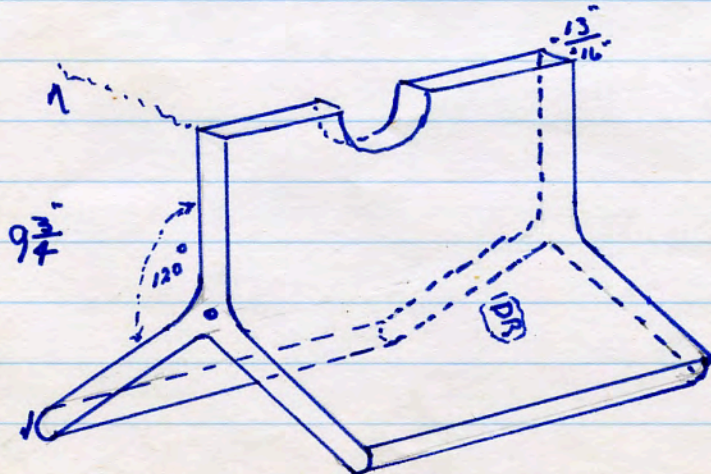

no name. no panels. red T.C. wall cap.

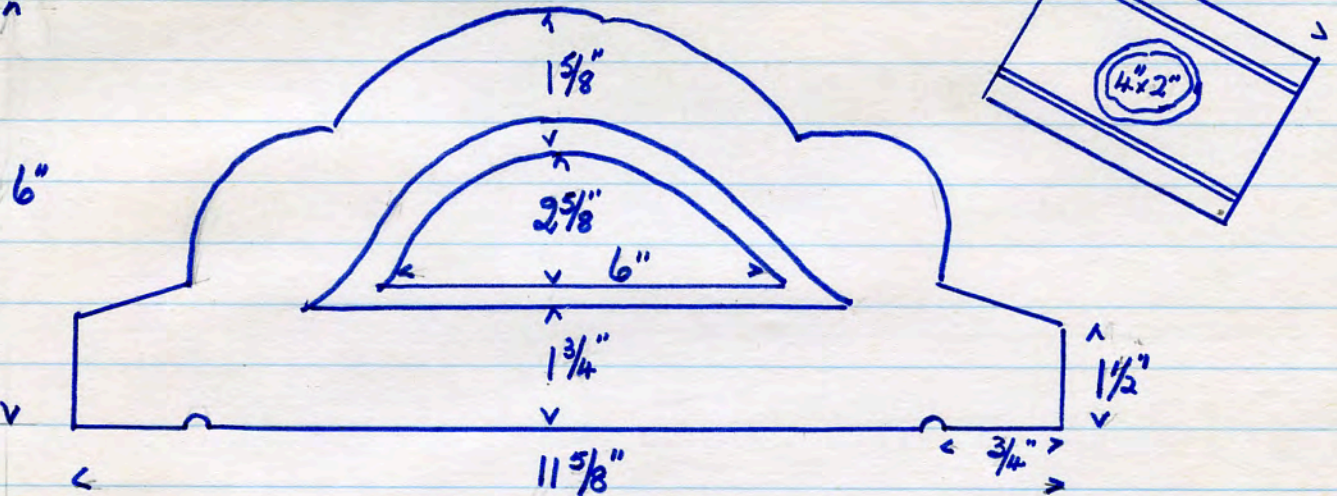

3018. 38 lbs. Rayton 24. 4. '83

W^o FARISH CHESTER blue paver.

9 lbs 9 1/8" x 4 3/8" x 2 3/4"

3032 single panel rev. letters incised
double chamfered square obv.
A Hulme. Rayton 1. 5. 83.

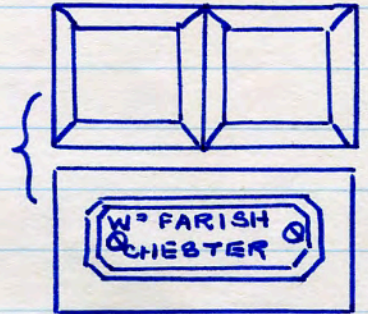

no name, no panels, red.

3033 decorative return bricks.

9 lbs. 9" x 4 1/2" x 3"

A. Hulme. Rayton (Hazel Grove Police Station dem - one of the only two on the building). 1. 5. 83.



J. C. EDWARDS RUABON. red pressed plinth

7 lbs. 8 1/8" x 4 1/8" x 3"

3053 single panel in base, letters clearly incised.
6 5/8" x 2 1/8" x 3/4" deep.

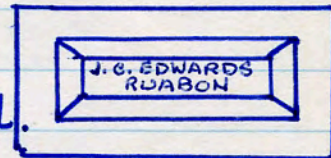

Gas Wks dem. Mersey St. Warrington 29. 5. 83.

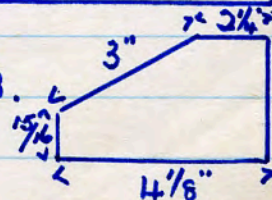

STAFFORD COAL & IRON CO LD blue plinth
7 lbs.

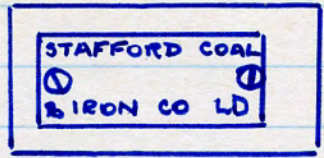

3054

single panel in base. $6\frac{1}{4}'' \times 2\frac{1}{4}'' \times \frac{9}{16}''$ deep.
letters incised 29. 5. 83.
R/wy Goods Warehouse dem. Warrington



GLOBE FIRECLAY WORKS BUCKLEY FLINTSHIRE.

3055

dec. blue pavement.
 $9\frac{5}{8}$ lbs. $11\frac{7}{16}'' \times 5\frac{3}{4}'' \times 1\frac{5}{8}''$
single panel in base $6\frac{7}{8}'' \times 3'' \times \frac{1}{4}''$ deep
letters incised, very faint.
Rose & brown St. off Mersey St. W/ton. 29. 5. 38.

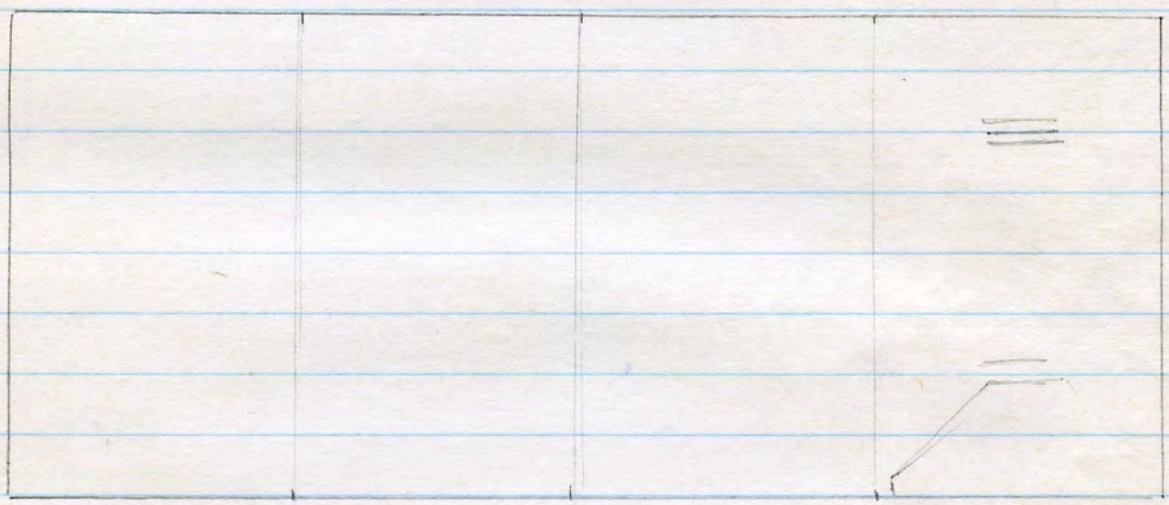
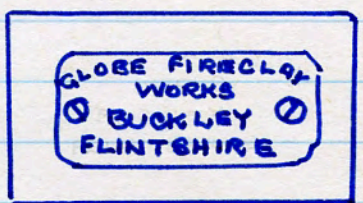

No name. blue paper used as road sett.

14 lbs. $8\frac{3}{8}" \times 5" \times 3\frac{3}{8}"$

3056

no panels. 8 x $1\frac{1}{2}"$ square chamfered studs

R/wy Wks dem. Darlington. 22. 5. 83.

No name. blue paper

3054. 15 lbs. $10" \times 5" \times 3\frac{1}{2}"$

no panels. 2 x $4\frac{1}{4}"$ square, chamfered studs.

R/wy Wks dem. Darlington. 22. 5. 83.

DENNIS RUABON HW3 Squint T.C.

7 lbs. $7\frac{1}{2}'' \times 4\frac{1}{4}'' \times 3\frac{1}{8}''$

3092

single panel each side, letters incised.

Chapel dem. Bolton 2. 6. 83.

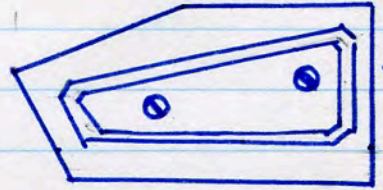
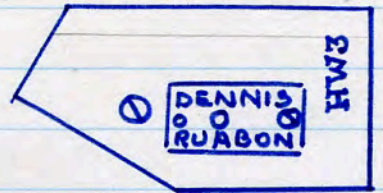

DENNIS RUABON obv. HW2 rev.

9 1/2 lbs. $8\frac{7}{8}'' \times 4\frac{1}{4}'' \times 3\frac{1}{8}''$

3093

single panel each side.

letters incised.

Chapel dem. Bolton 2. 6. 83.

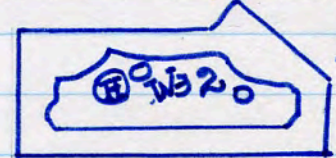
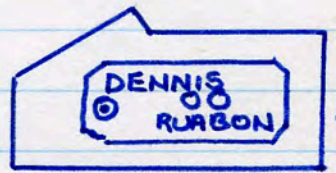

DENNIS RUABON WC1 obv.

9 lbs. $8\frac{3}{4}'' \times 4\frac{1}{4}'' \times 3\frac{1}{8}''$

3094

single panel each side

letters incised.

Chapel dem. Bolton 2. 6. 83.

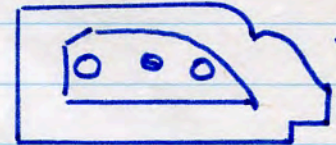
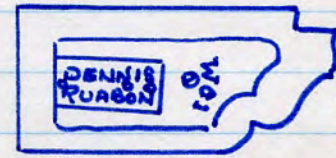

[Wood & Ivory Ltd. West Bromwich. 1879]

W & I blue jamb (Staffordshire Knot)

9 1/2 lbs. $9'' \times 4\frac{1}{2}'' \times 2\frac{1}{8}''$

3126

single panel obv only. letters in relief, plain rev.

Central Station dem. Manchester. 12. 6. 83.

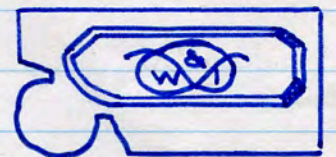

W blue paper (double letter) broken ends.

3127

9 lbs. $10'' \times 5\frac{3}{4}'' \times 2\frac{1}{8}''$ (original probably 12" long).

single panel rev. diamond pattern in relief obv.

letter incised, star in relief.

Central Station dem. Manchester. 12. 6. 83.

(P & S Wood, Pump House Brick Works,
West Bromwich. 1885)

 Trade Mark



[Gas. Livesey, Highfield Rd. Sedley 1879]

LIVESEY red jamb, (broken) clay
5 1/2 lbs. 6 1/2" x 4 3/8" x 3" (part).

3128

single panel each side, letters incised
Central Station dem. M/n. 12. 6. 83.

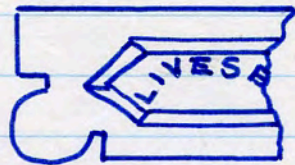

CLIFF WORTLEY buff, ornamental gauged stretcher.
7 lbs. 9" x 4 3/8" x 2 7/8" - 2 5/16".

single panel each side.

3129

letters in relief, both sides alike.

A1 stamped on end.

Central Station dem. M/n. 12. 6. 83.

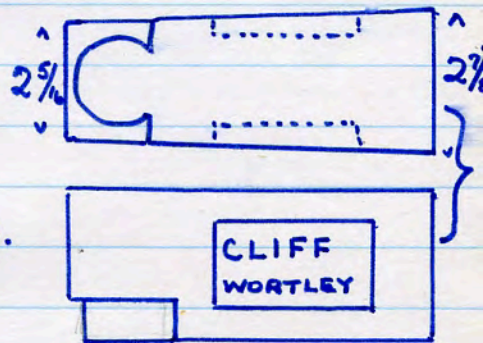

CLIFF WORTLEY buff, ornamental gauged header.

7 lbs. 8 7/8" x 4 5/16" x 2 9/16" - 2 1/4"

single panel each side.

3130

letters in relief, both sides alike.

B1 stamped on end

Central Station dem. M/n. 12. 6. 83.

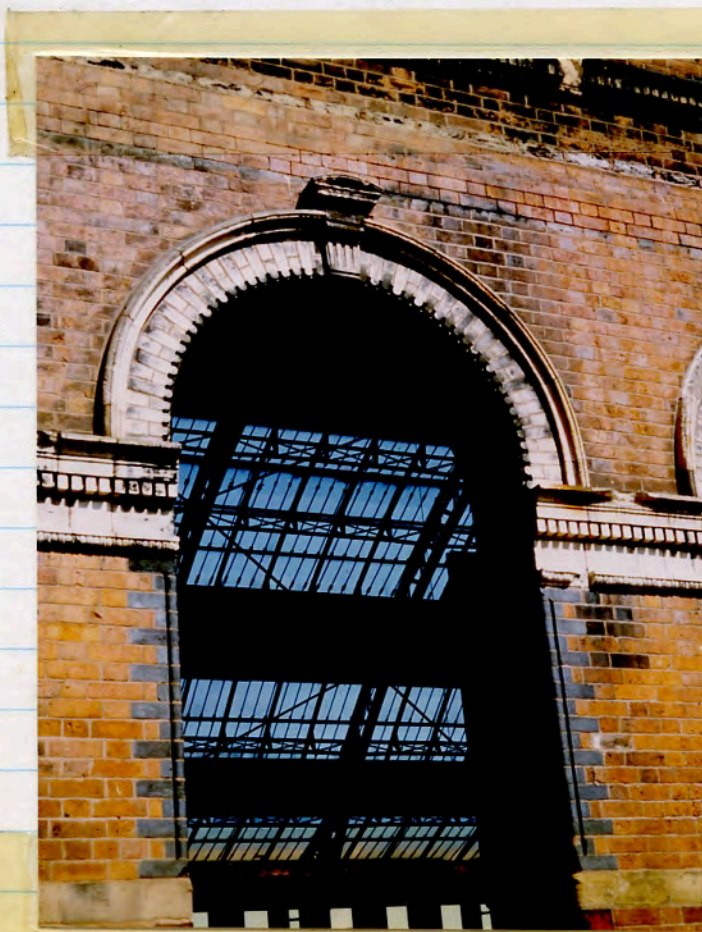

No name, red dec. boss. (colliery shale) no panels.
Leigh corp. Baths dem. 16. 6. 83

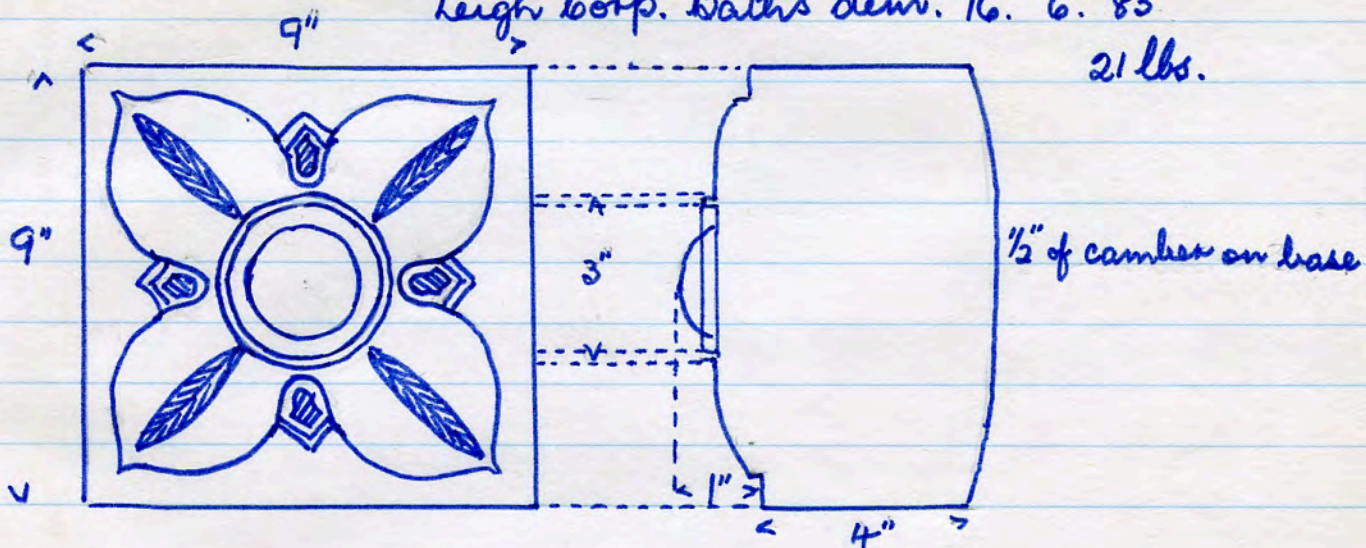

No name, red, dec. corner return of dado.

Leigh corp. Baths dem. 16. 6. 83

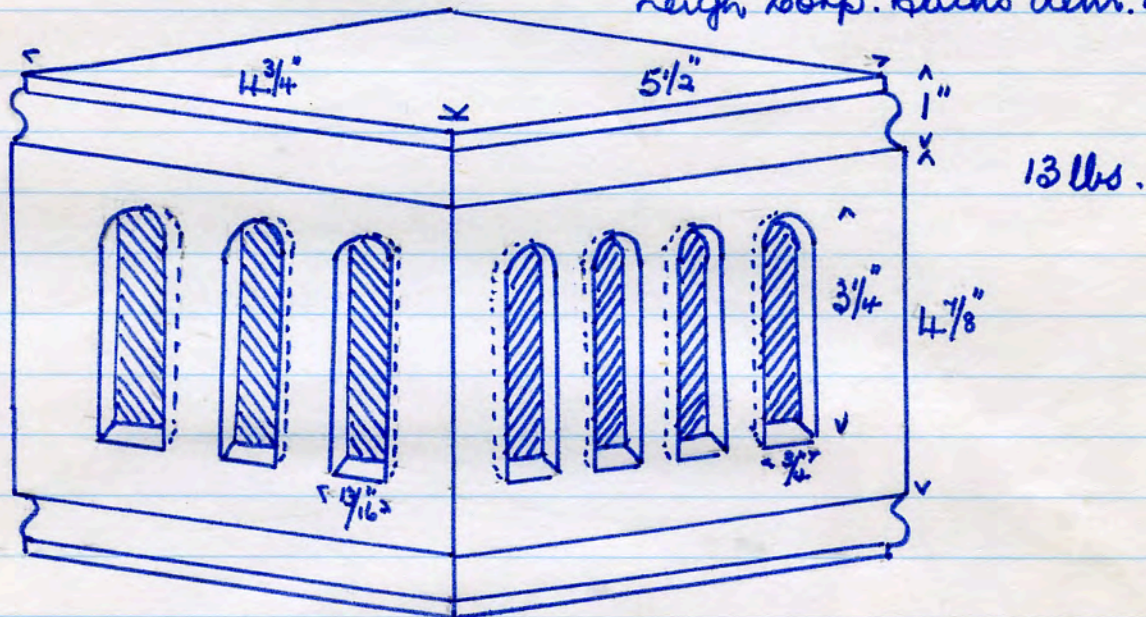

No name, red, starter for jamb return, panel in rev. edge.
Leigh corp. Baths dem.

16. 6. 83

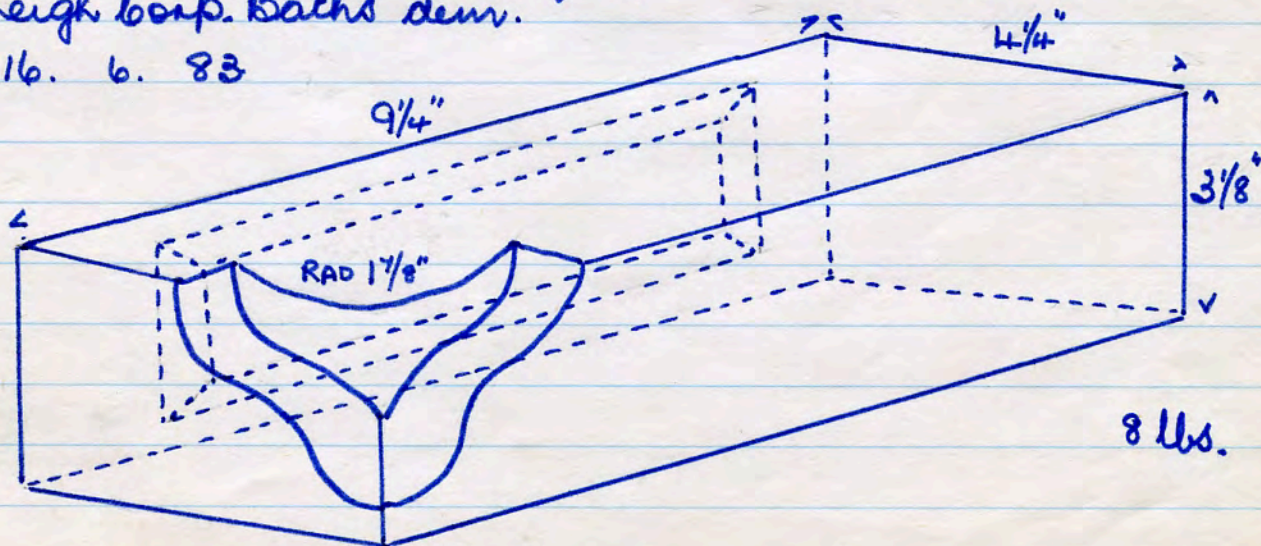

These three pieces combine to form a recessed pilaster to doorway.

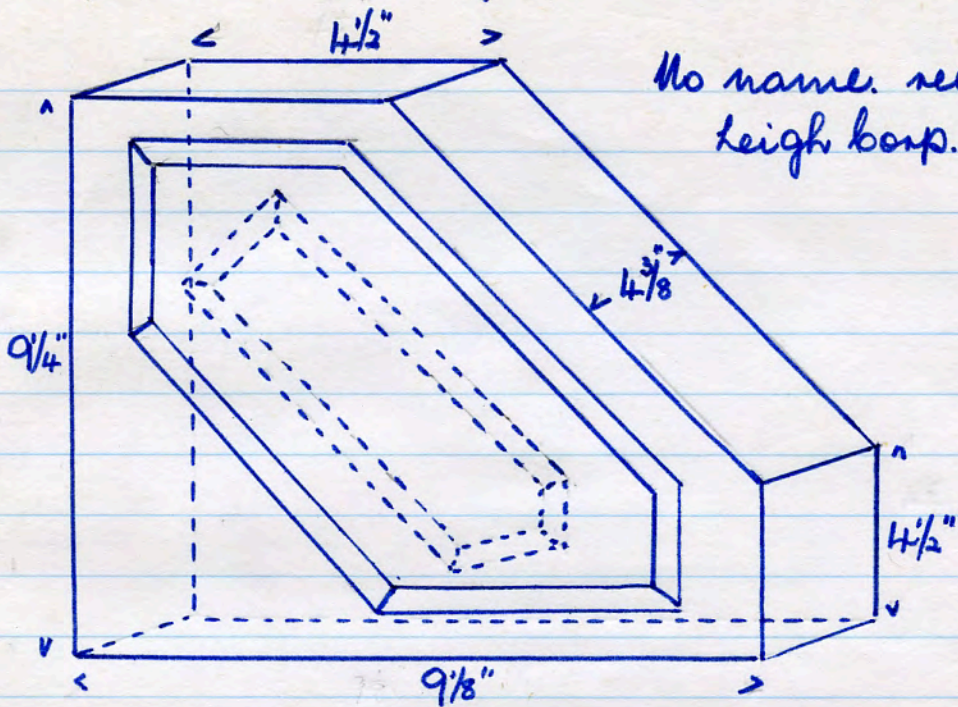

No name. red colliery shale.
Leigh hosp. Baths dem.

16. 6. 83.

18 1/2 lbs.

3134

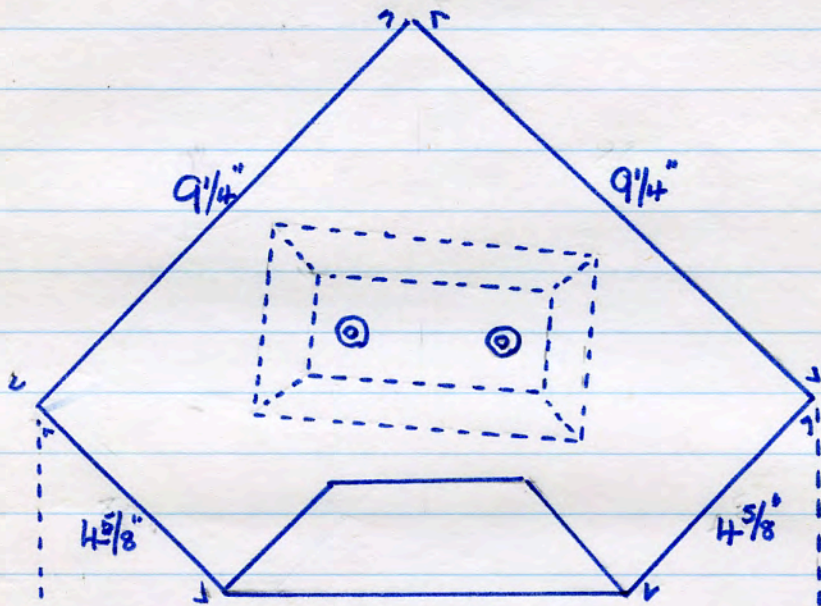

14 lbs.

3135

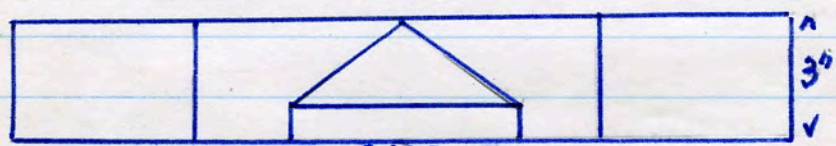
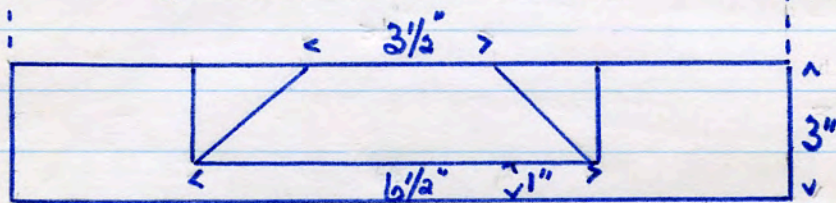

12 lbs.

3136

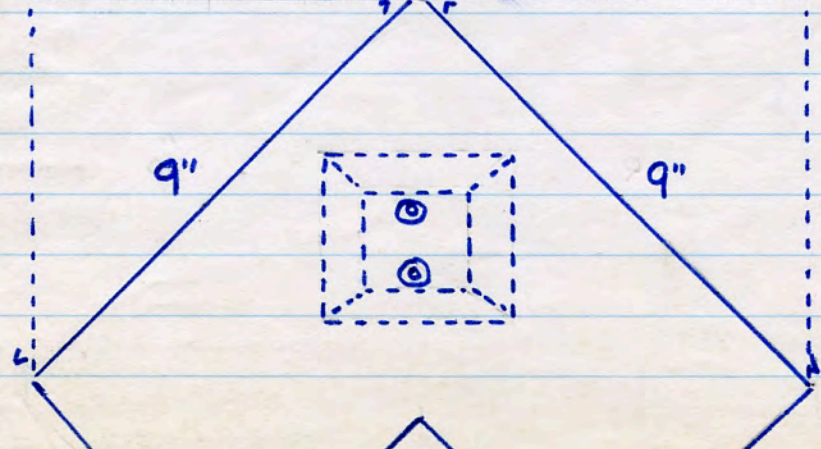

No name, V 59 (Dennis Ruabon)

grey T.C.

14 lbs.

3137.

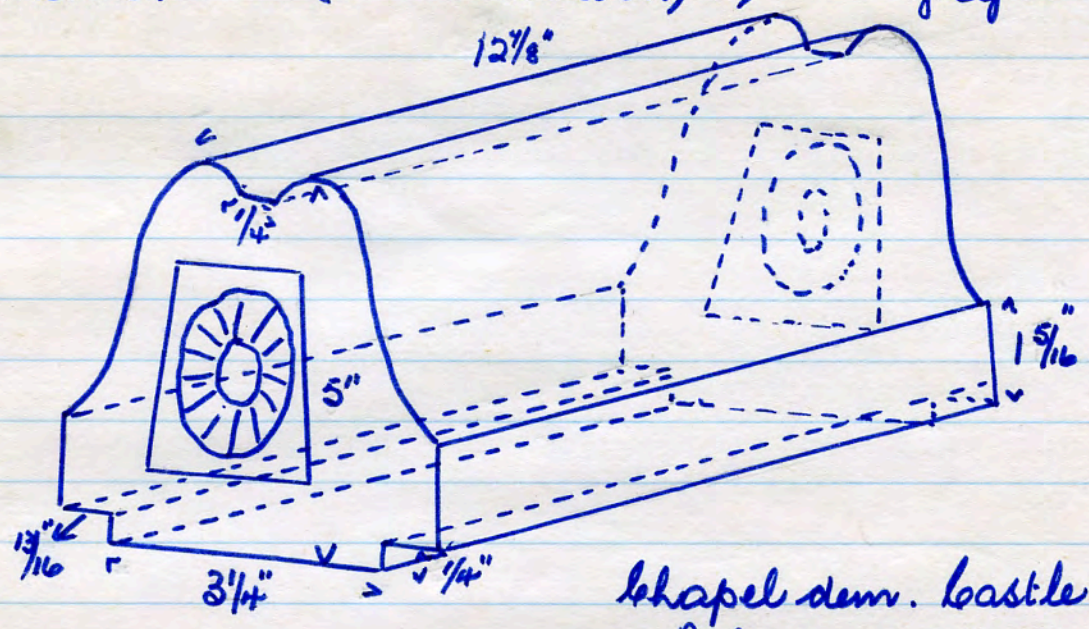

Chapel dem. bastle st.
Bolton. 9. 6. 83.

No name, V 23 (Dennis Ruabon)

grey T.C.

23 lbs.

3138.

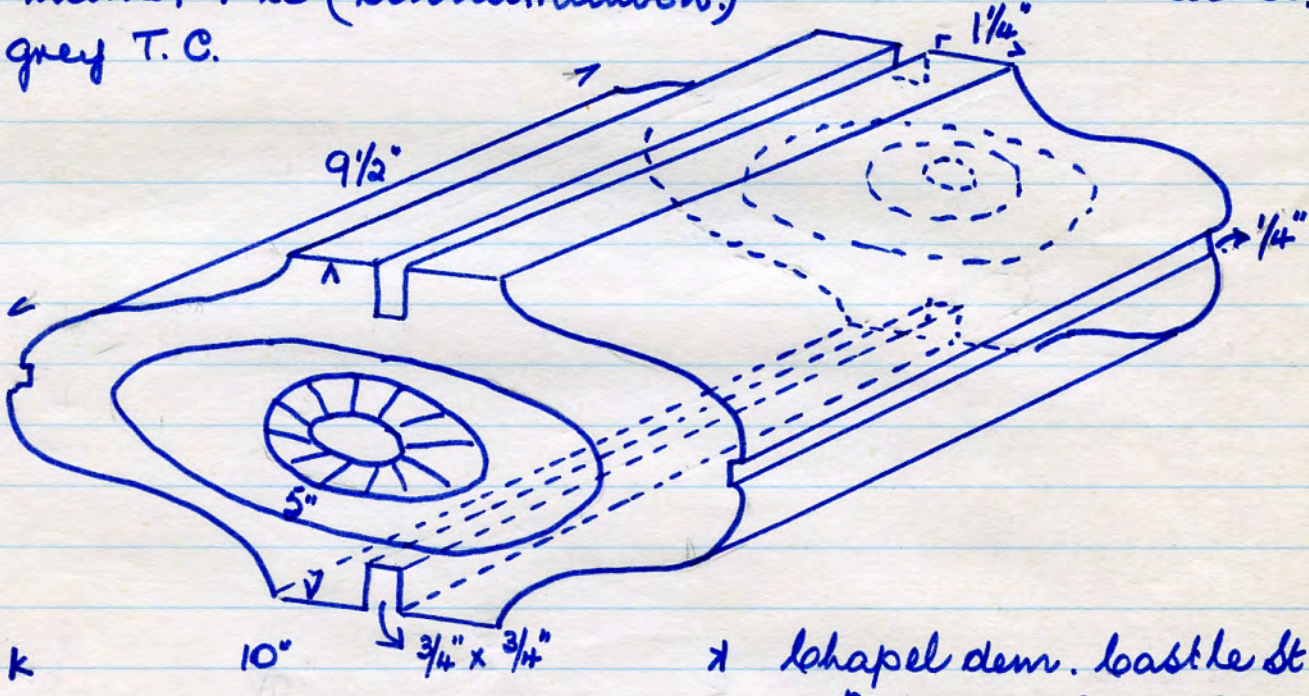

Chapel dem. bastle st
Bolton 9. 6. 83.

No name, v 86 (Dennis Ruabon) 23 lbs.
grey T.C.

FROGS IN
BASE

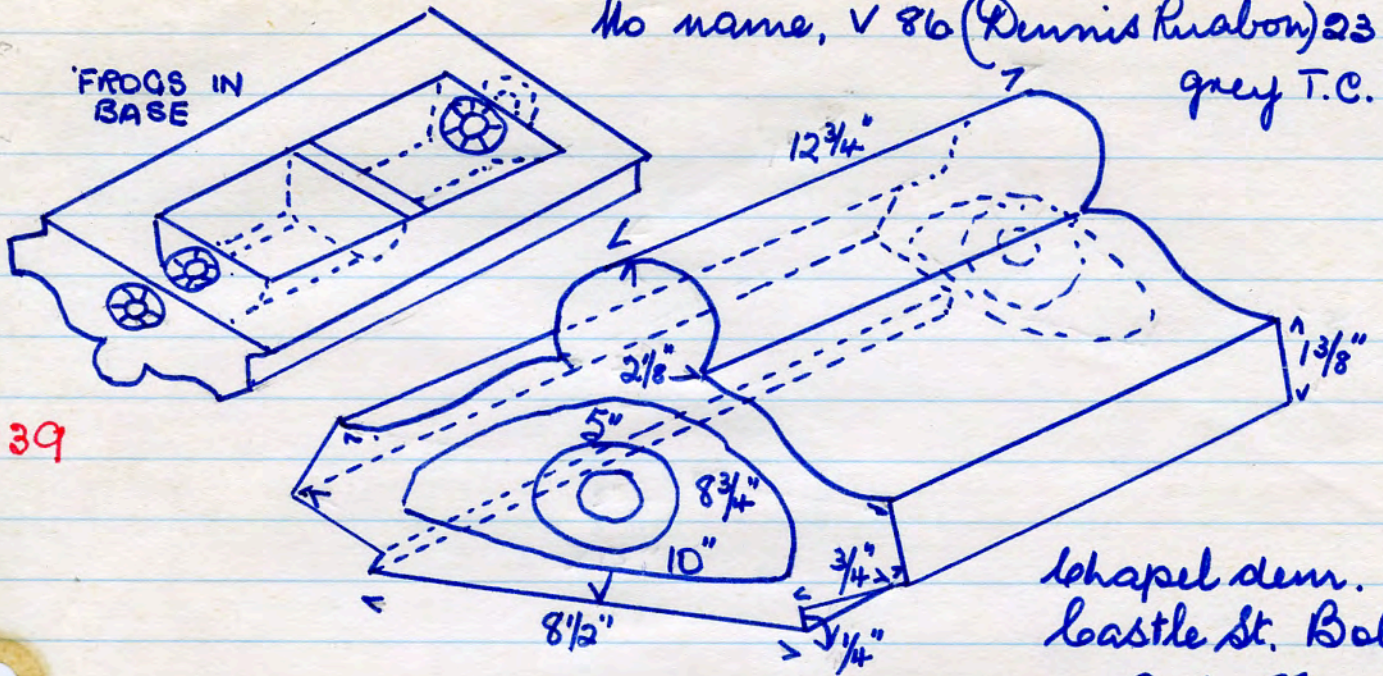

3139

Chapel dem.
Castle St. Bolton
9. 6. 83.

No name, v 204 (Dennis Ruabon) grey T.C.

14 lbs.

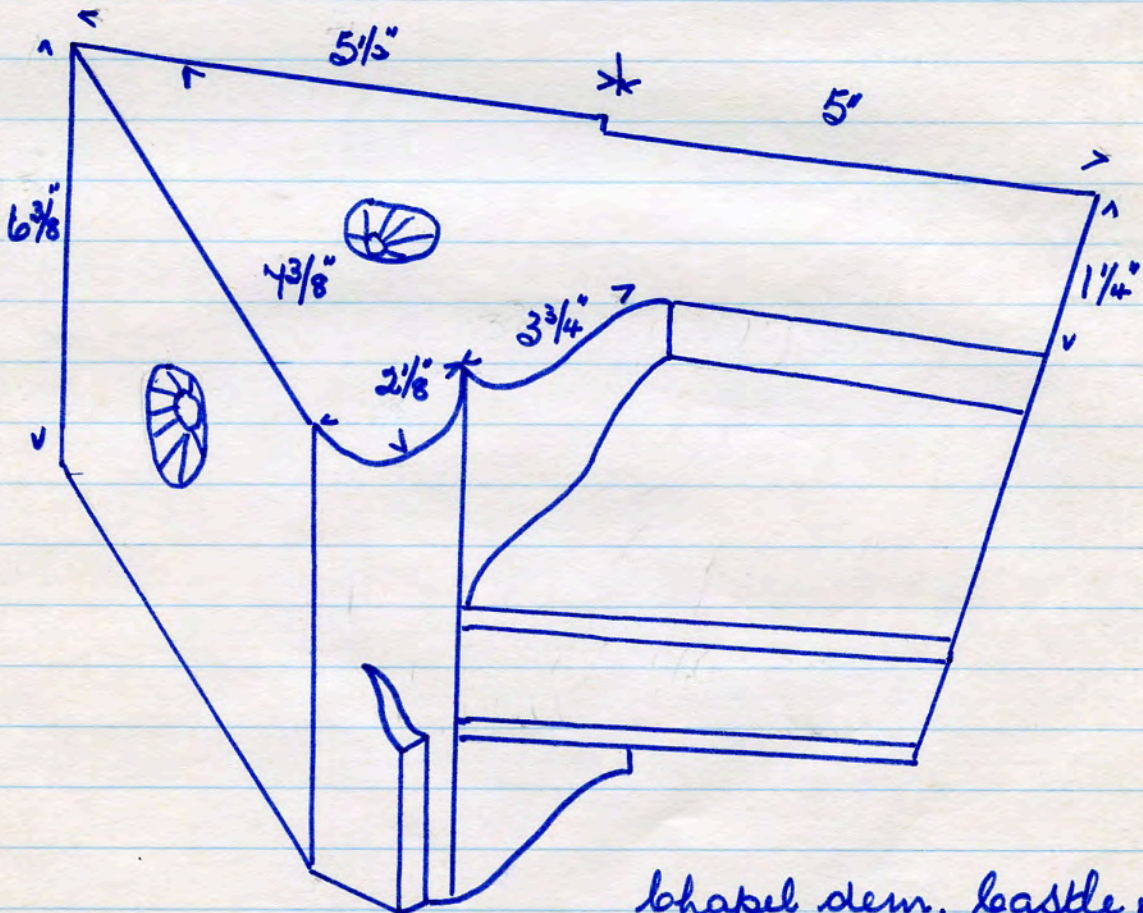

3140

Chapel dem. Castle St.
Bolton. 9. 6. 83.

3142

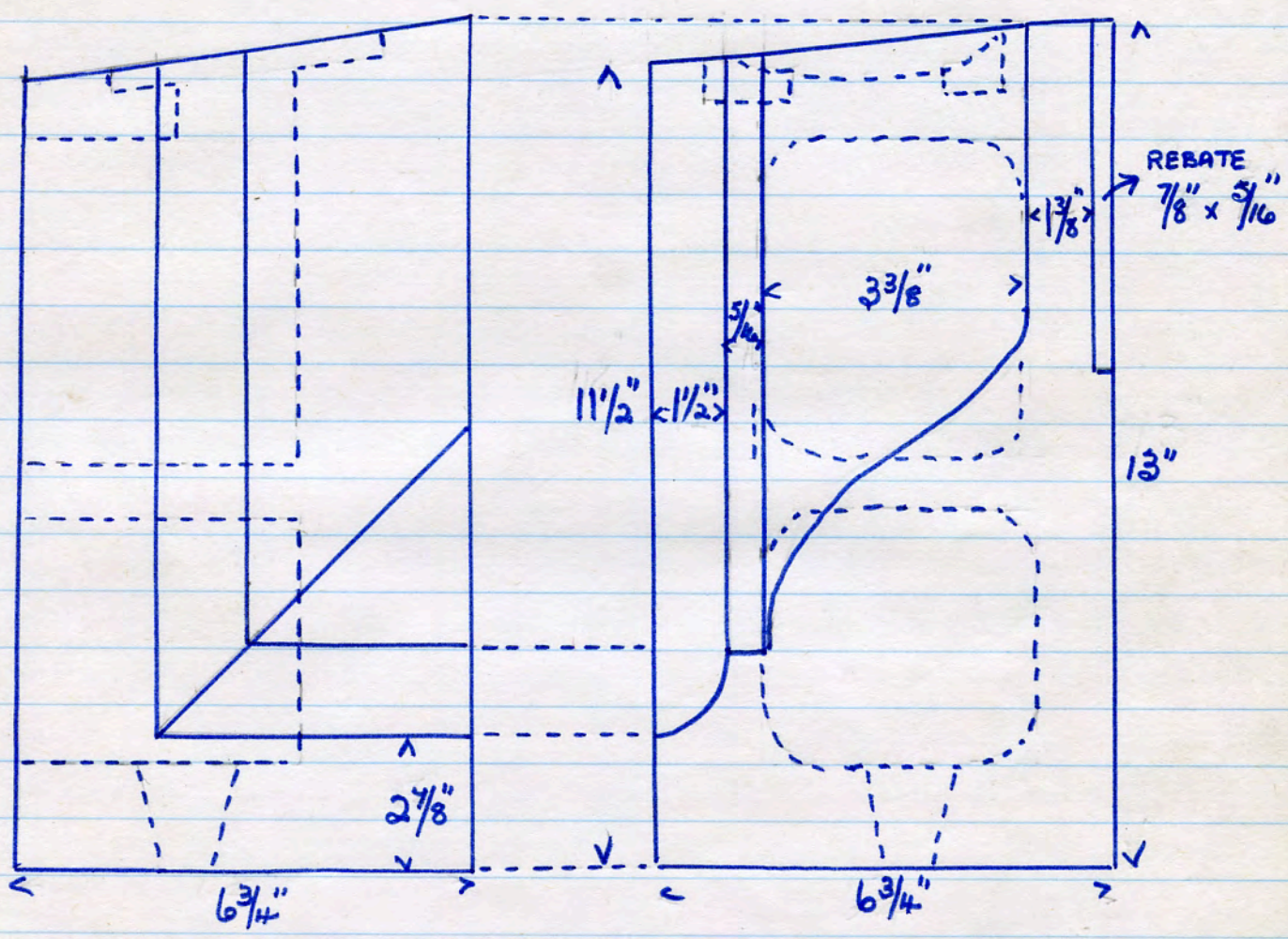

No name, V 24. (Dennis Ruabow). grey F.C. 21 lbs.
Chapel dem. castle St. Bolton. 9. 6. 83.

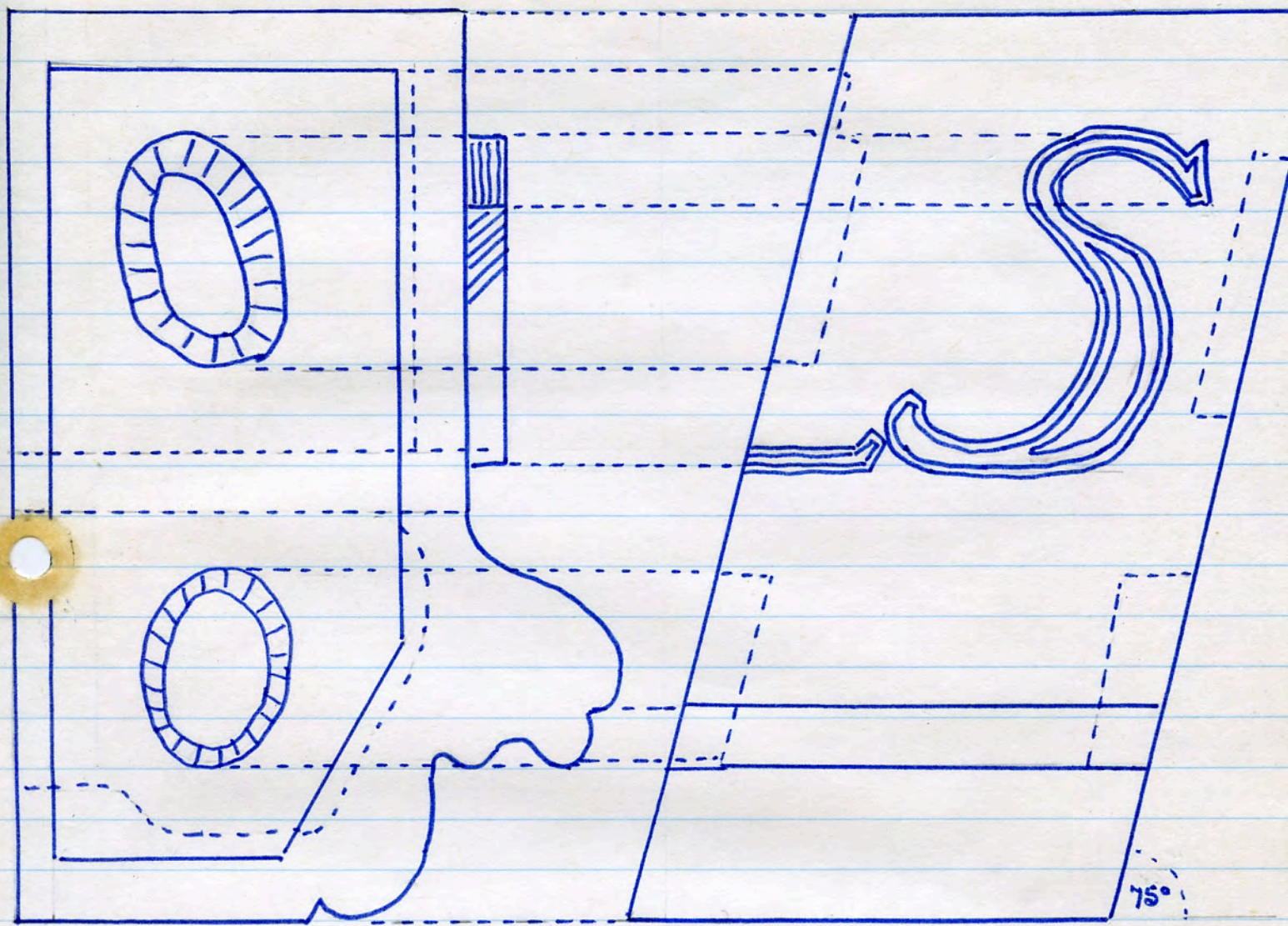

3143.

No name, V231 (Dennis Ruabon) grey T.C. 62 lbs.
Chapel dem. Bastille St, Bolton 9. 6. 83.

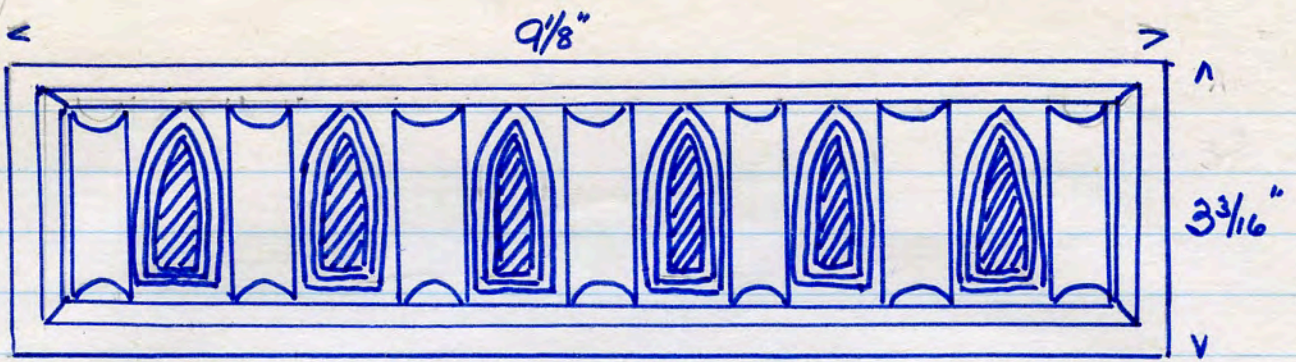

No name. red ventilator T.C.
 4 1/2 lbs. 9/8" x 3 3/16" x 3"

3144

Park side Spinningbo mill dem. Edge have
 Royton. 23. 6. '83.

No name. blue.
 9 lbs 12 1/2" x 5" x 2 7/8"



3168. no panels. S-O-T. 3. 7. 83.
 chapel dem. Murray St. Goldenhill

No name. blue.
 24 lbs. 13 3/4" x 9 3/4" x 2 5/8"



3169 no panels. quadrant moulded edge.
 chapel dem. Murray St. Goldenhill. S-O-T. 3. 7. 83.

J. BENNETT BASFORD dec blue paver.
 6 lbs. 8 3/4" x 4 1/2" x 2 3/8" (right hand)

3170 single panel rev. letters incised
 square studs 5/8" x 5/8" in relief obv.
 Franklyn St. dem. Hanley. 3. 7. 83.

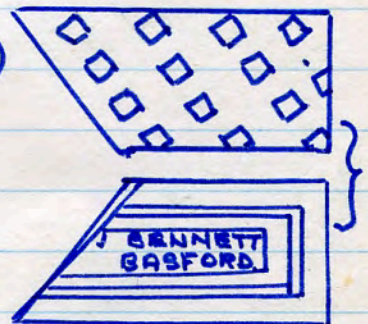

3171 as 3170 but opposite hand (left hand)

J JOLLEY ETRURIA blue paver. plain
 8 lbs. 9 1/2" x 4 3/4" x 2 5/16"

3172 single panel rev. letters incised
 Franklyn St. dem. Hanley. 3. 7. 83.

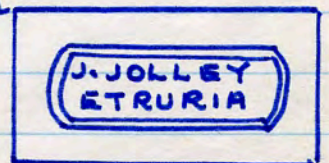

3173. No name. blue. window sill brk.
 8 lbs. 9" x 4 1/2" x 3"
 single panel 1 side only.
 H. R. Johnsons Isles. dem. section
 S-O-T 3. 7. '83.

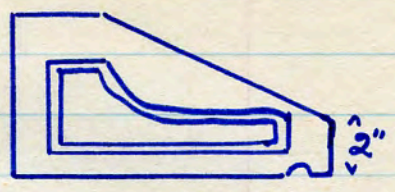

3174. No name REG NO 372095 blue ventilator
 8 lbs. 9" x 6 1/4" x 2 1/2" marked rev
 6 air perfs. 4 3/8" x 1/4" on rev.
 5 dec panels between perfs. obs
 Mollart St (adj. to Fire Station &
 Police Station) S-O-T. 3. 7. '83.

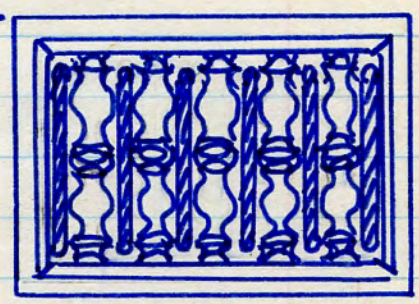

3175. No name (Mori). red T.C. dec brk.
 9 lbs. 8 5/16" x 4 3/8" x 3"
 no panels.
 Internal wall dem. "Rayfield"
 Thornfield Ave. W/foot. 20. 7. 83.



3202. No name (Shaws) 170 / 42 (L. TAYLOR) glazed sill.
 16 lbs. 9 3/4" x 7 1/2" x 6 1/8".
 single shallow panel each end
 1 1/2" diam. perf each end
 cavity in base (scraped) 8" x 4" x 5/4" deep.
 biscuit coloured glaze face edge.
 numbers & letters incised.
 kiln dem (old stock) Shaws, Darwen 22. 7. 83.

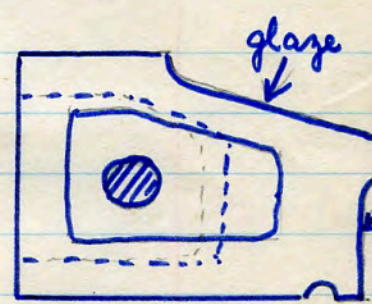

No name (Shaws) KW 1A use unknown. fine clay.
14 lbs $8\frac{1}{2}" \times 9\frac{1}{8}"$ (edge to edge) $\times 4"$
no panels. letters incised.

3203

Kiln dem. Shaws. Darwin. 22. 7. 83.

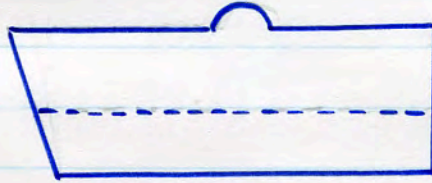
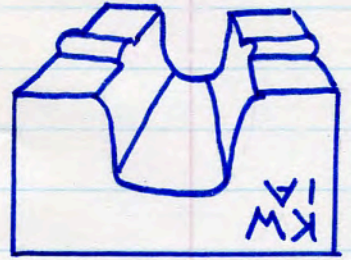

No name (Shaws) 193 (1A (W. WILSON) .
floor tile for surround of pool.

14 lbs. $12" \times 9\frac{3}{4}" \times 3"$ shallow panel each end
large panel in base $7" \times 6\frac{1}{2}" \times 1\frac{1}{2}"$ deep. $\frac{3}{4}"$ perf each end.
double nosing on face edge. with

3204

large water drip $1\frac{1}{4}" \times \frac{5}{8}"$
black glaze on face & face edge
1" square incised pattern on face. - anti skid.



No name (Shaws) use unknown. unglazed. brown.
5 lbs. $10\frac{1}{4}" \times 3\frac{3}{16}" \times 3\frac{3}{16}"$ made by extrusion
1 cavity throughout. no panels.

3205

key for fixing on both internal sides.
Kiln dem. Shaws. Darwin 22. 7. 83.



No name (Shaws) use unknown, brown unglazed.
8 lbs $9\frac{5}{8}" \times 5\frac{5}{8}" \times 4\frac{7}{8}"$ double sided skinning (?)
for use with Shaws Twintiles, to make room divisions

3206

2 cavities throughout $2" \times 1"$

fixing V groove in top

Kiln dem. Shaws. Darwin

22. 7. 83

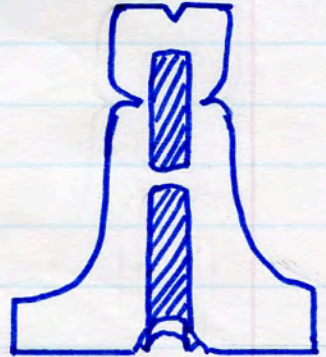

SHAWS DARWEN dentil mould, light grey, matt

2 lbs. $5\frac{1}{4}" \times 4" \times 2\frac{1}{4}"$

shallow panel each end.

3207

name stamped " "

cavity in rev. $2\frac{1}{2}" \times 3\frac{3}{4}" \times 1"$ deep.

Kiln dem. Shaws. Darwin. 22. 7. 83.

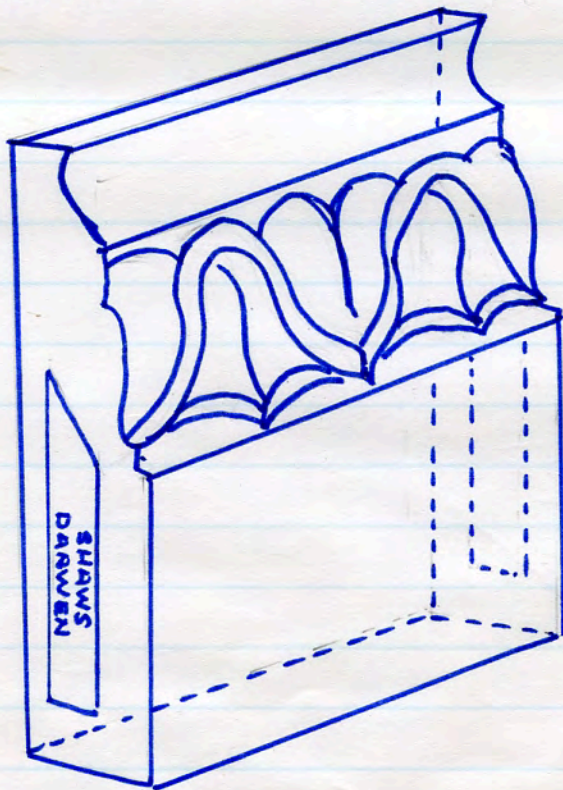

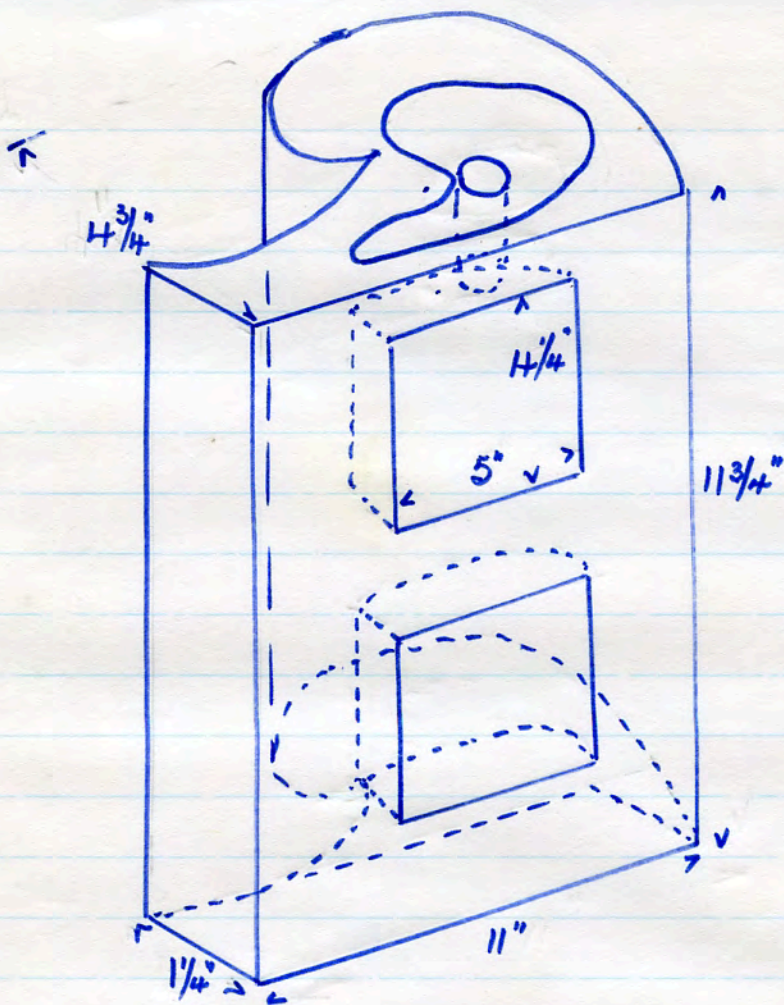

3210

no name red T. C wall cap
 24 lbs. shallow panel each end, perf each end.
 2 cavities in base - scraped by hand
 Red Bank. Betham Hill. M/x. 31. 7. 83.
 Roger St.

No name, red corbel
 7 lbs 9" x 4 3/8" x 3/8"

3228

single panel each side
 dem. house, Heyside, Royton 23. 10. 83.

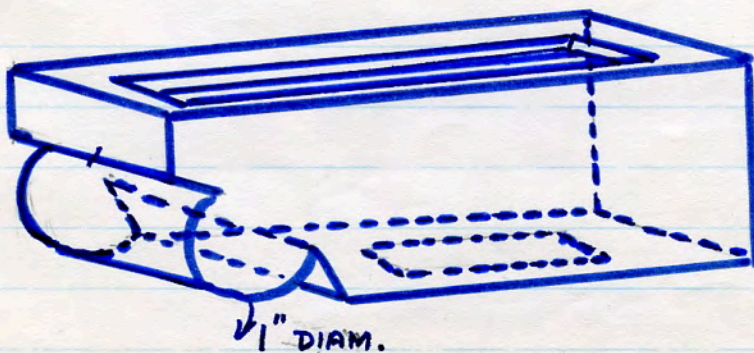

No name, red window head (made at Huncoat)
 10 lbs special made brk to cover cast iron lintel
 no panels, 2 perfs $1\frac{3}{4}$ " diam $11" \times 4\frac{1}{4}" \times 3\frac{1}{8}"$
 Baburnum Mill dem. Atherton

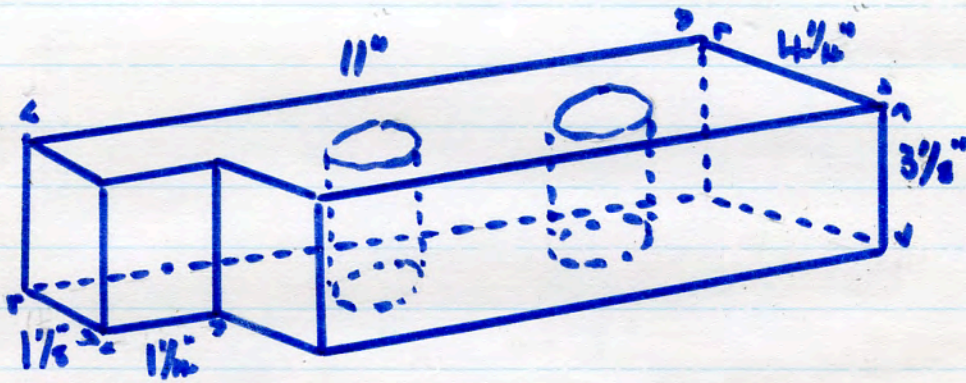

No name, specially made sill brk by Huncoat Brk Co
 19 lbs no panels. $9" \times 9" \times 4\frac{3}{4}"$
 $\frac{1}{2}"$ $\frac{1}{2}$ round throating + $1\frac{3}{4}"$ $\frac{1}{2}$ round throating

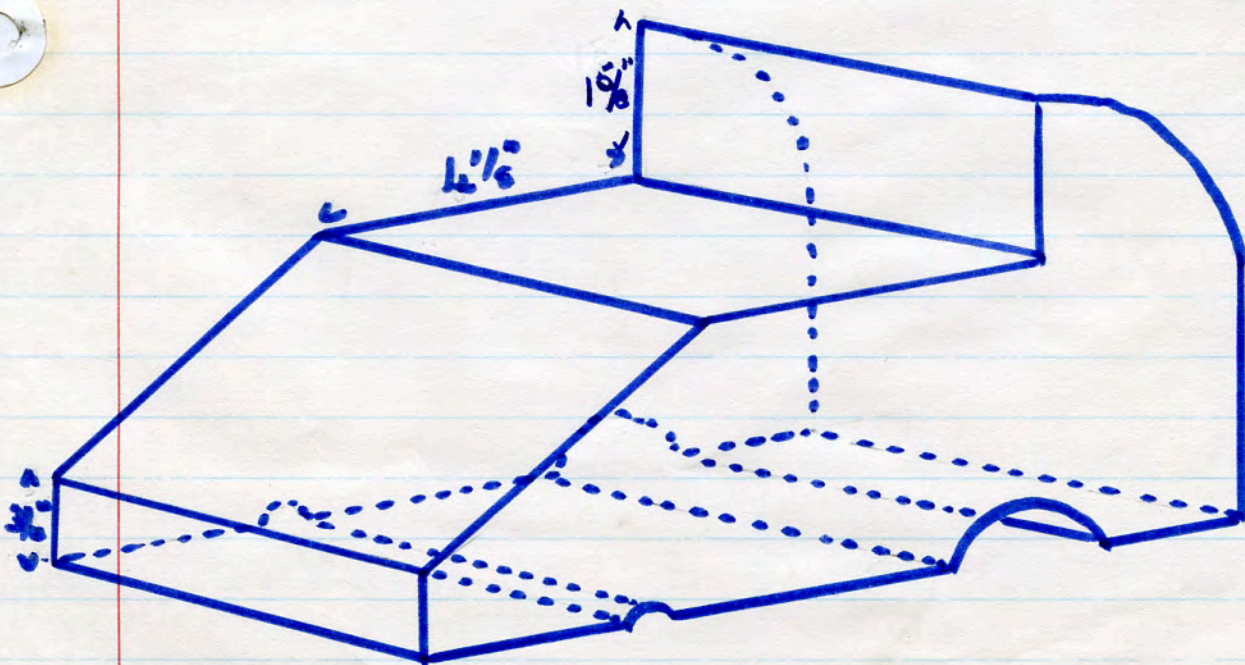

14/82

No name A10

14 lbs.

red T C moulded and
weathered window
head angle.

ACTUAL SIZE.

4 4"

6 1/2"

3234

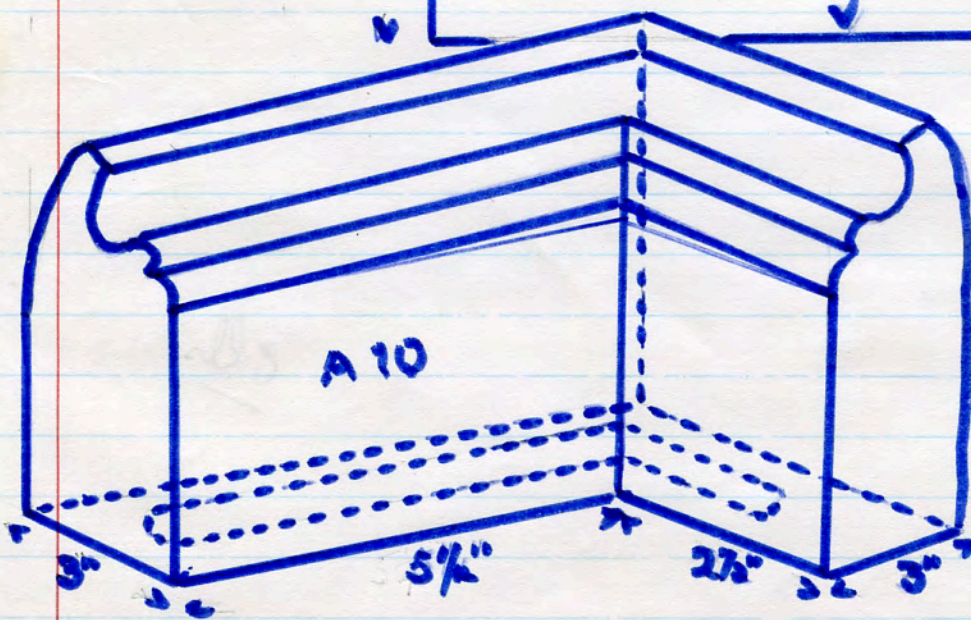

dem of Bolton co-operative Dances, St George's Rd, Bolton.

9. 11 82

No name WG 2, red T.C. specially made (Huncoat B + Y.L. Co.)

7 lbs.

single panel 1 side only. letters stamped.

Bolton Co-operative Dairy dem. St George's Rd. 11. 11. '83.

3236

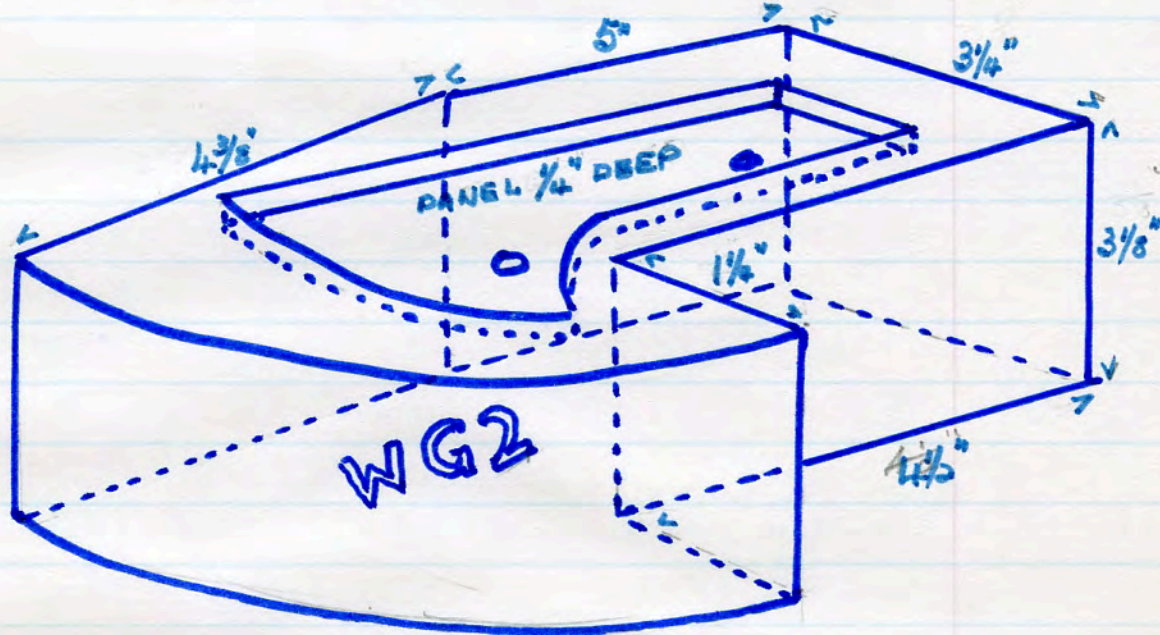

No name dec string course.

3254

7 lbs. $9\frac{1}{4}'' \times 4\frac{3}{8}'' \times 2\frac{1}{8}''$

no panels.

star incision $1\frac{1}{8}''$ deep

Roughdales. Sutton Rd. St Helens 18. 11. 83.



No name, red paver. 8 studs $3'' \times 2''$

8 lbs. $8\frac{1}{8}'' \times 4\frac{3}{8}'' \times 2\frac{1}{4}''$

3350

single shallow panel in base (pennant)

Wilfred St. dem. Godwick, Oldham. 15. 10. 84

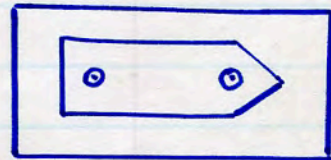

No name. red paver. 8 studs $1\frac{7}{8}'' \times 1\frac{7}{8}''$

8 lbs. $8\frac{3}{4}'' \times 4\frac{1}{4}'' \times 2\frac{1}{4}''$

3351

single panel in base (rectangular)

Wilfred St. dem. Godwick, Oldham. 15. 10. 84

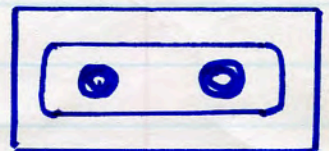

No name. Red T.C pier cap. (Bolton made).

77 lbs. $16\frac{1}{2}'' \times 16\frac{1}{2}'' \times 4''$ (high), width of margin $4\frac{1}{2}''$
hand scraped cavity in base.

Bury Old Rd, Bolton. (house dem) 11. 11. 83.

3258

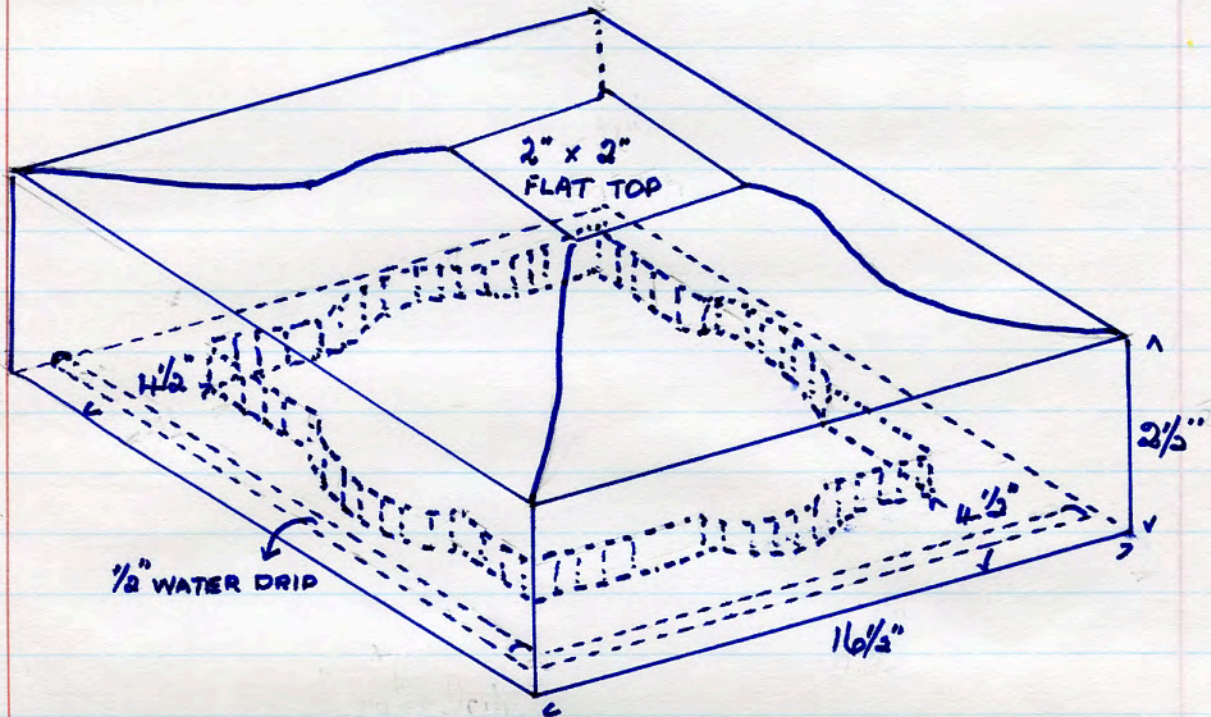

5 lbs.
 $9\frac{1}{2}'' \times 8\frac{1}{2}'' \times \frac{7}{8}''$

3259

No name. Salt glazed. dec. path edging.

G. Lenney, Knott St. Bacup. 6. 11. 83

No name A7 dec T. C. stretch, return end of label
8 lbs. $8\frac{7}{8}$ " x $6\frac{1}{2}$ " x 3" mould.
cavity in rear $6\frac{1}{2}$ " x 1" x $1\frac{1}{2}$ " deep.

3262. Bolton Co-op Dairy, garage dem. 30. 11. 83.

No name A26 dec T. C. red, return end to above,
10 lbs. 6" x $6\frac{3}{4}$ " inc. projection x $4\frac{1}{2}$ ".

3263. cavity in rear $3\frac{3}{8}$ " x $2\frac{1}{4}$ " x 3"
Bolton Co-op Dairy, garage dem. 30. 11. 83.

No name **A13** (Wm. Fletcher, Horwich).

14 lbs

red T.C return end to sill.

3269

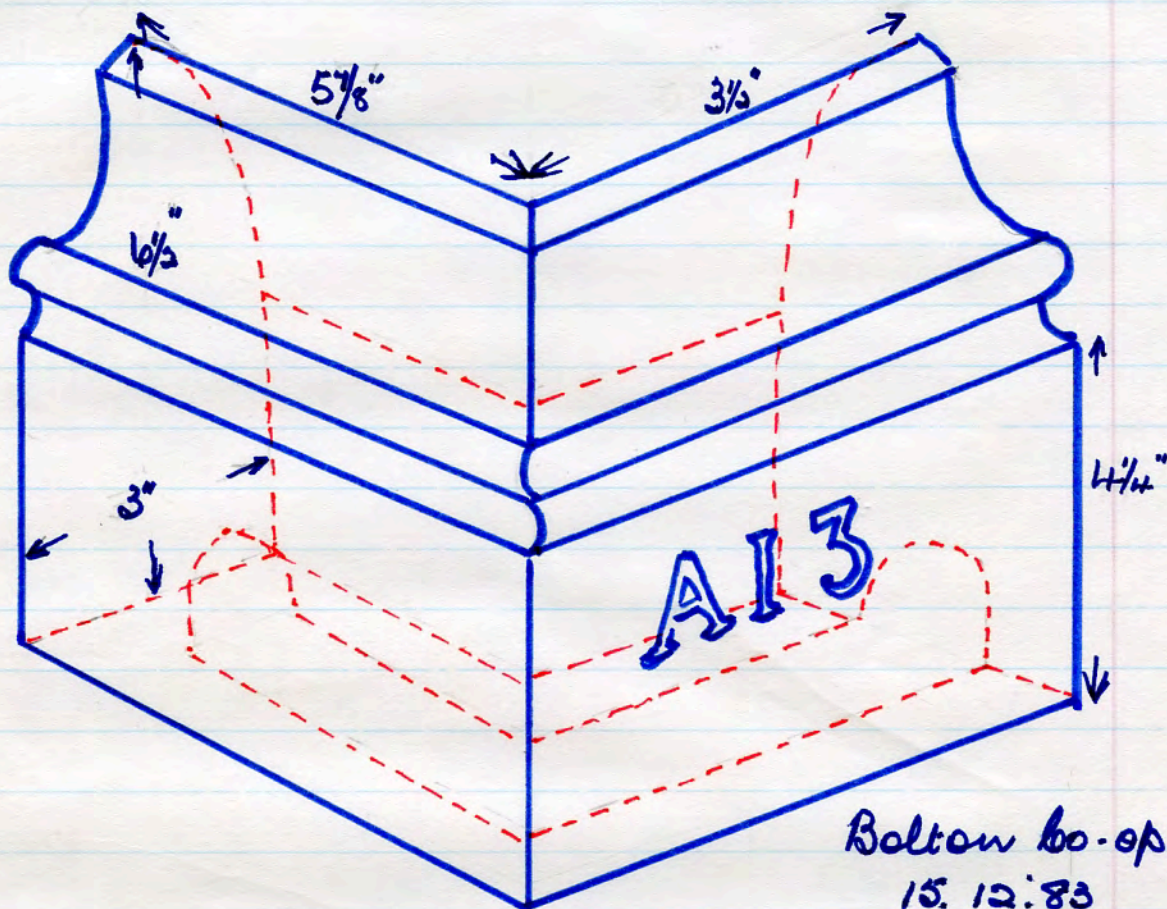

Bolton Co-op Dairy
15. 12. 83 dem.

3270

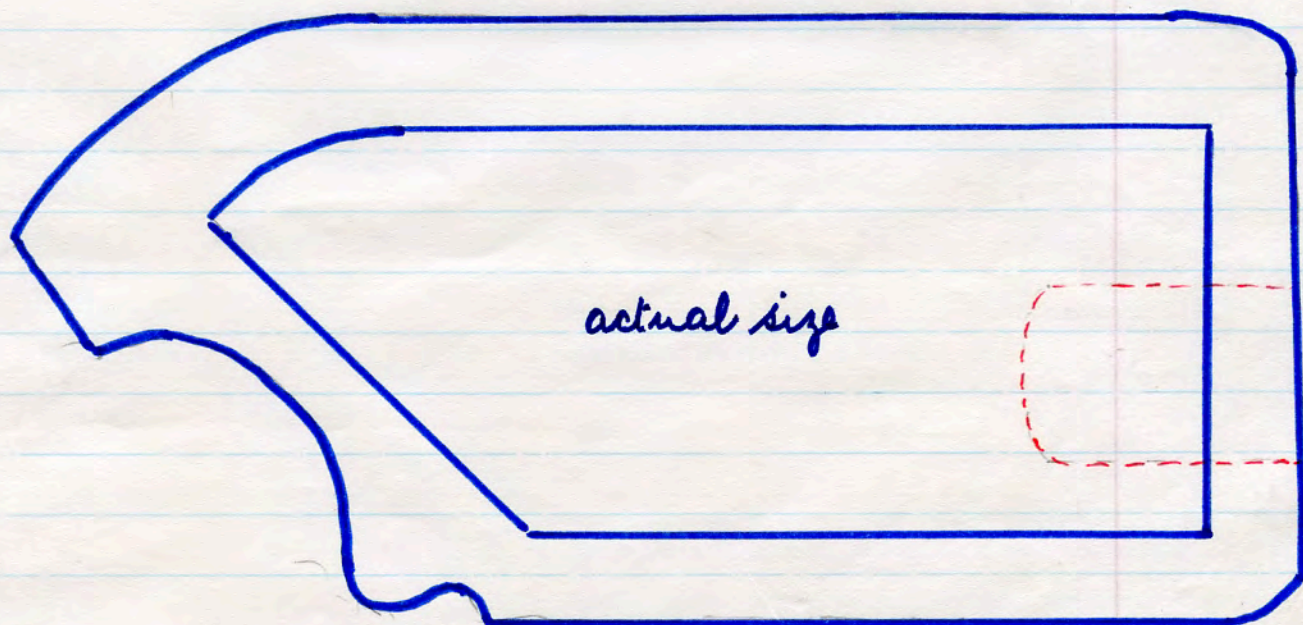

AG Ww FLETCHER & SONS HORWICH

red T.C. dec. stretchers

single panel each end.

12 lbs. 8 5/8" x 6 5/8" x 3/8"

Bolton Co-op Dairy dem. 15. 12. 83.

3271

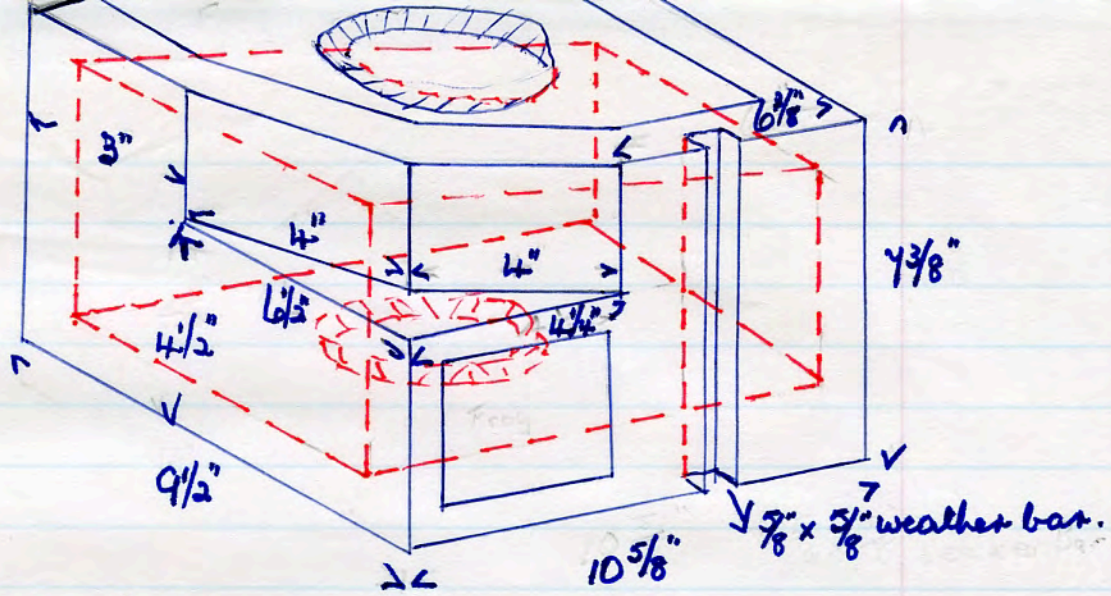

No name. (Wm Fletcher & Sons, Horwich) red T.C.
 31 1/2 lbs
 Bolton bo-op Dairy dem. 15. 12. 83.

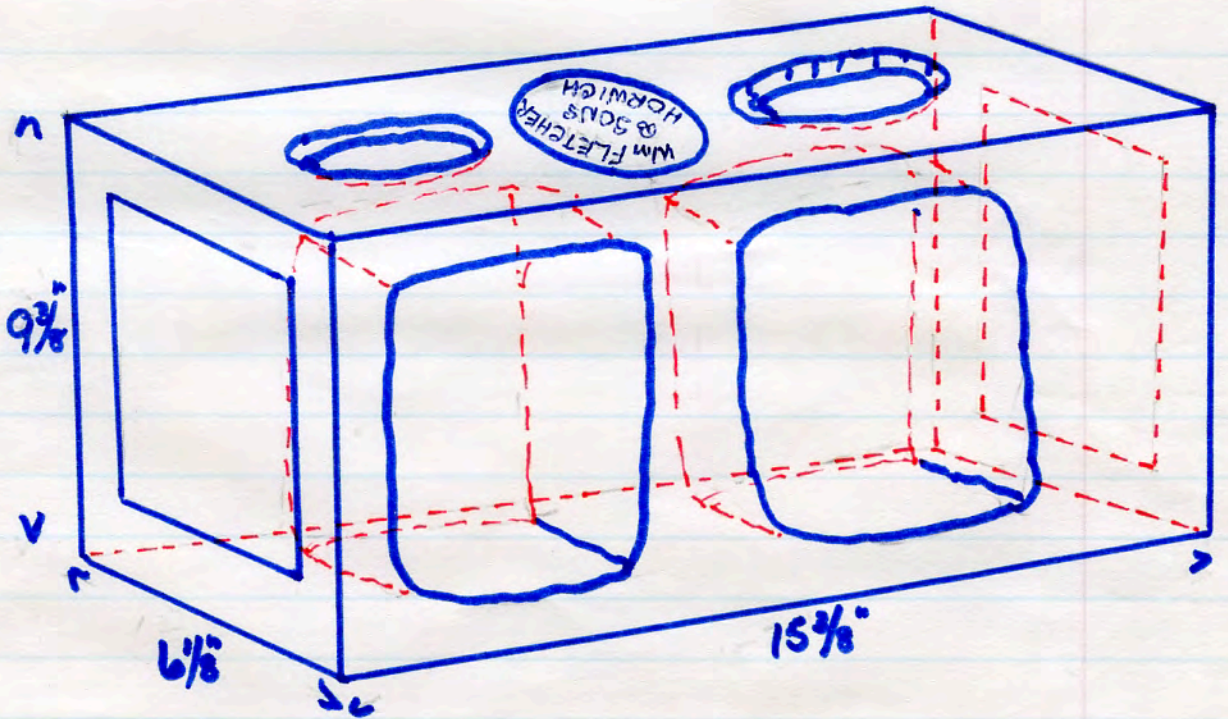

3272

WM FLETCHER & SONS HORWICH red T.C.
 42 lbs. 15 3/8" x 9 3/8" x 6 1/8"
 single panel each end. 2 cavities (to be filled with
 aggregate) finger scraped.
 letters stamped
 Bolton bo-op Dairy dem. 15. 12. 83.

S © E REQD NO 804561 CABLES.

7 1/2 lbs, 10 1/4" x 6" x 2"

no panels. letters incised

Salford Corporation yard, Princes Rd. 25. 3. 84.

3284

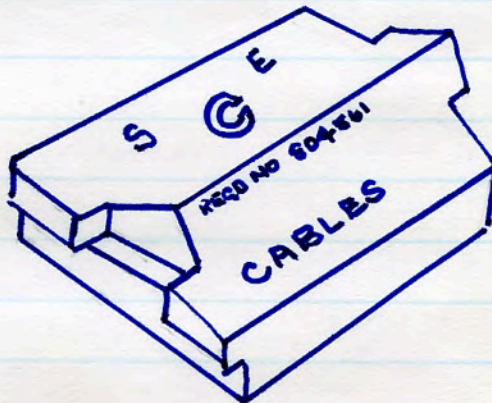

K 867 L furnace block
14 lbs letters stamped.
18 perfs 5/8" x 5/8"

S. Walkinson's, Blackley 1. 4. 84.

3286

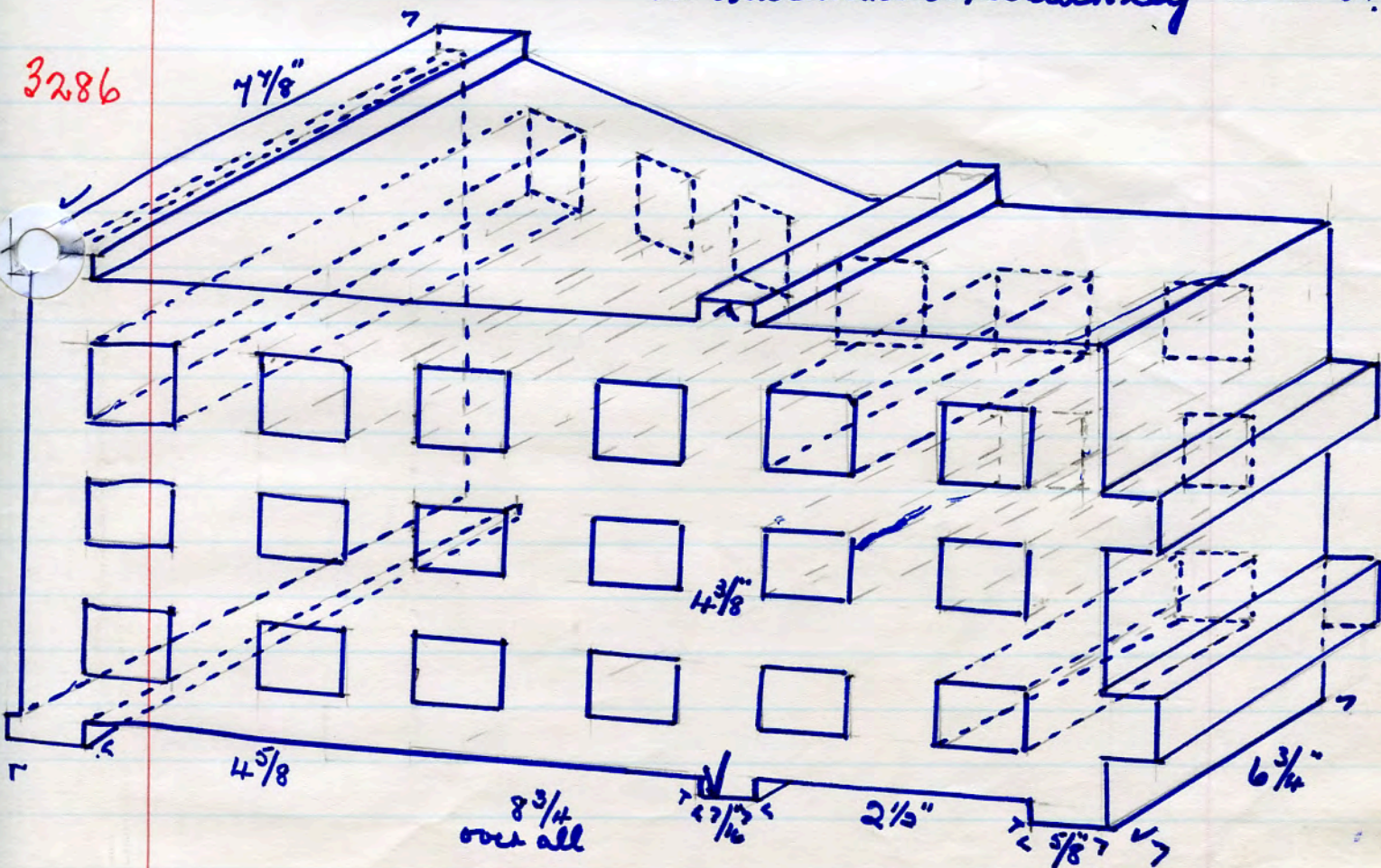

W HANCOCK & CO HAWARDEN blue paver.

8 lbs. $9\frac{1}{8}" \times 4\frac{3}{8}" \times 3"$

3295

single panel rev. letters incised

2 x $3\frac{1}{2}" \times 3\frac{1}{2}"$ chamfered $\frac{1}{2}"$ studs

S. Spencer (Llandudno) 6. 4. 84



No name. red ventilator. terra cotta.

3298

6 lbs. $8\frac{7}{8}" \times 5\frac{1}{4}" \times 2\frac{7}{8}"$

3 perfs $1\frac{3}{4}" \times \frac{1}{2}"$. 6 perfs $1" \times \frac{3}{4}"$

3 perfs $\frac{3}{4}" \times \frac{3}{4}"$

Facit Quarry dump. 28. 6. 84.

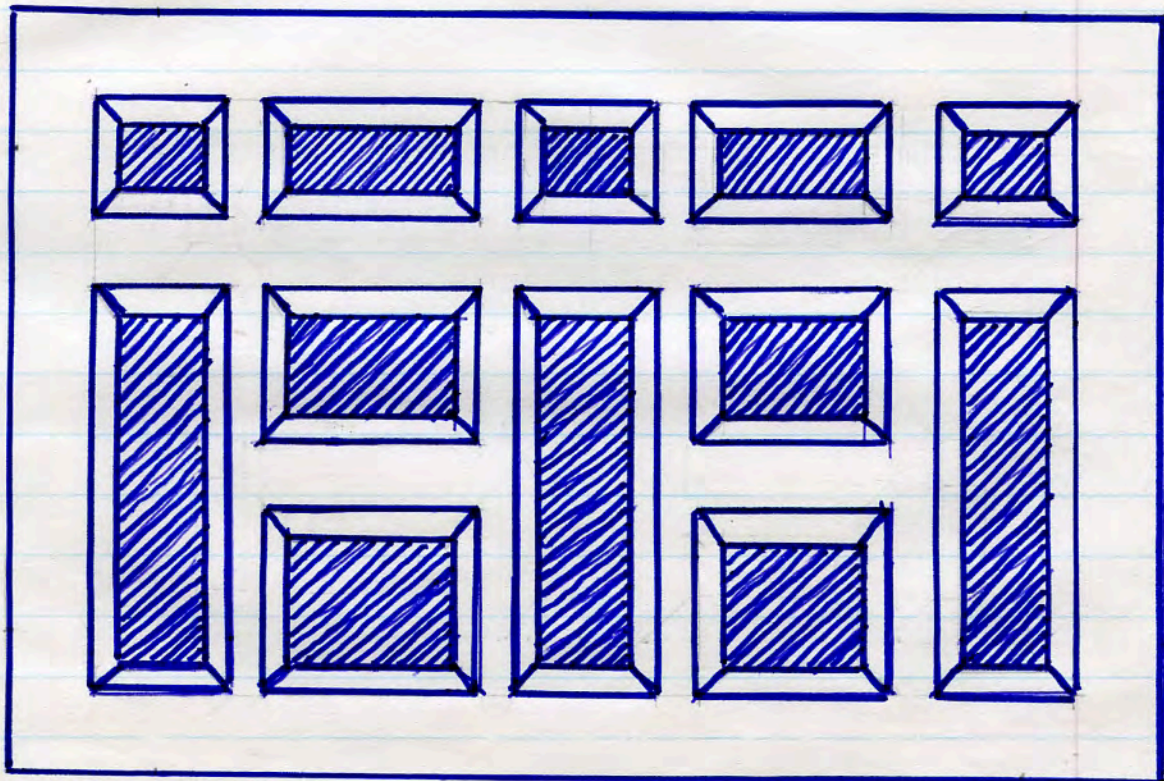

No name, part red (dec) paver. studded

7 lbs. $9" \times 4\frac{1}{4}" \times 1\frac{1}{2}"$.

3313

single panel in rev.

Pioneer Bk kiln dem.

Quick Edge. Goston, Oldham.

22. 4. 84



No name 1032 stamped on 1 edge.
Des. T.C. plaque with floral motif.

3312

8 lbs. $6\frac{1}{2}'' \times 6\frac{1}{2}'' \times 2\frac{1}{2}''$

scraped panel in rev. showing finger marks (small).
Pioneer Bats kiln dem. Quick Edge. Sutton, 22. 7. 84.

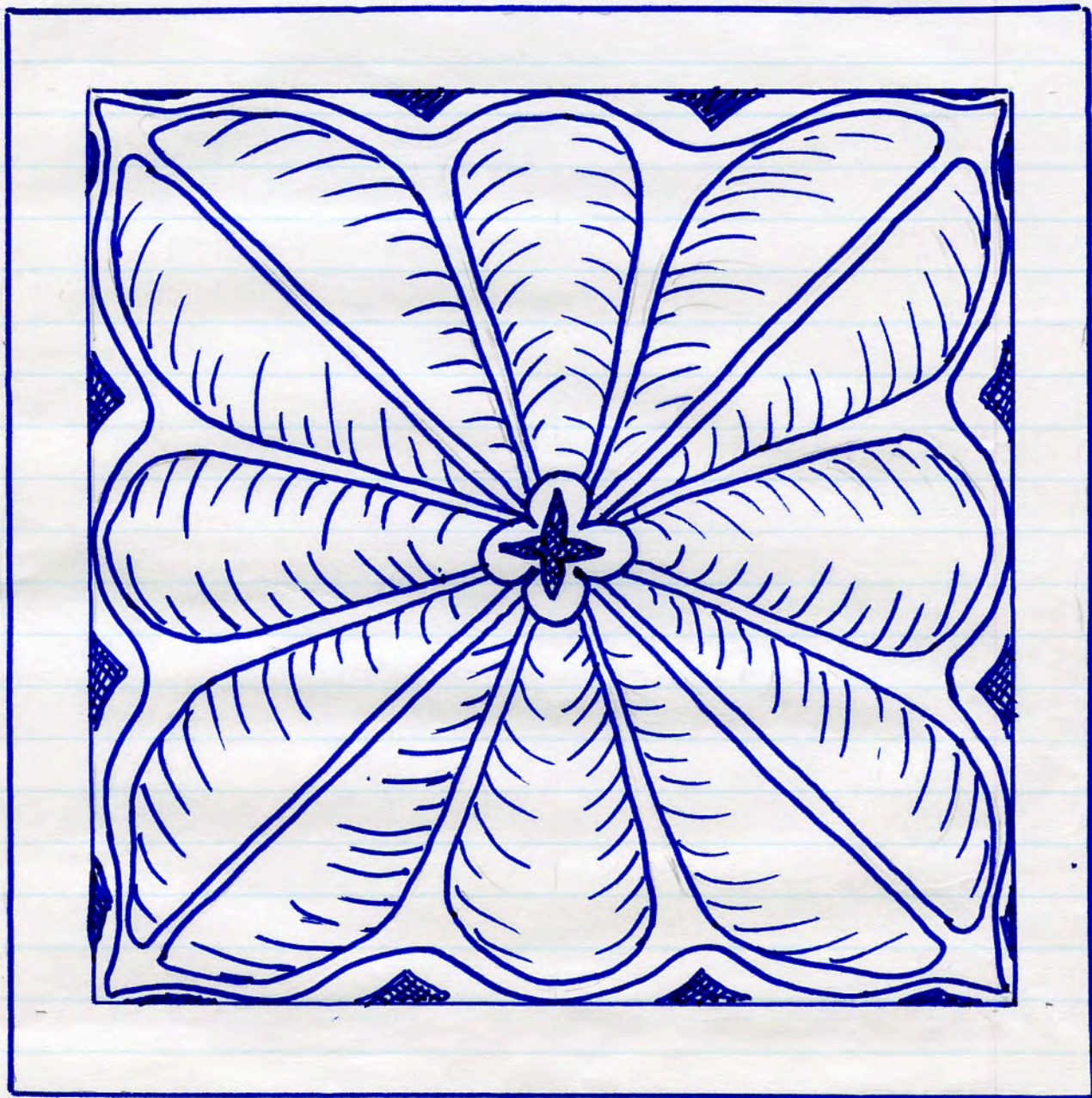



No name. blue ridge tile

26 lbs.

3319

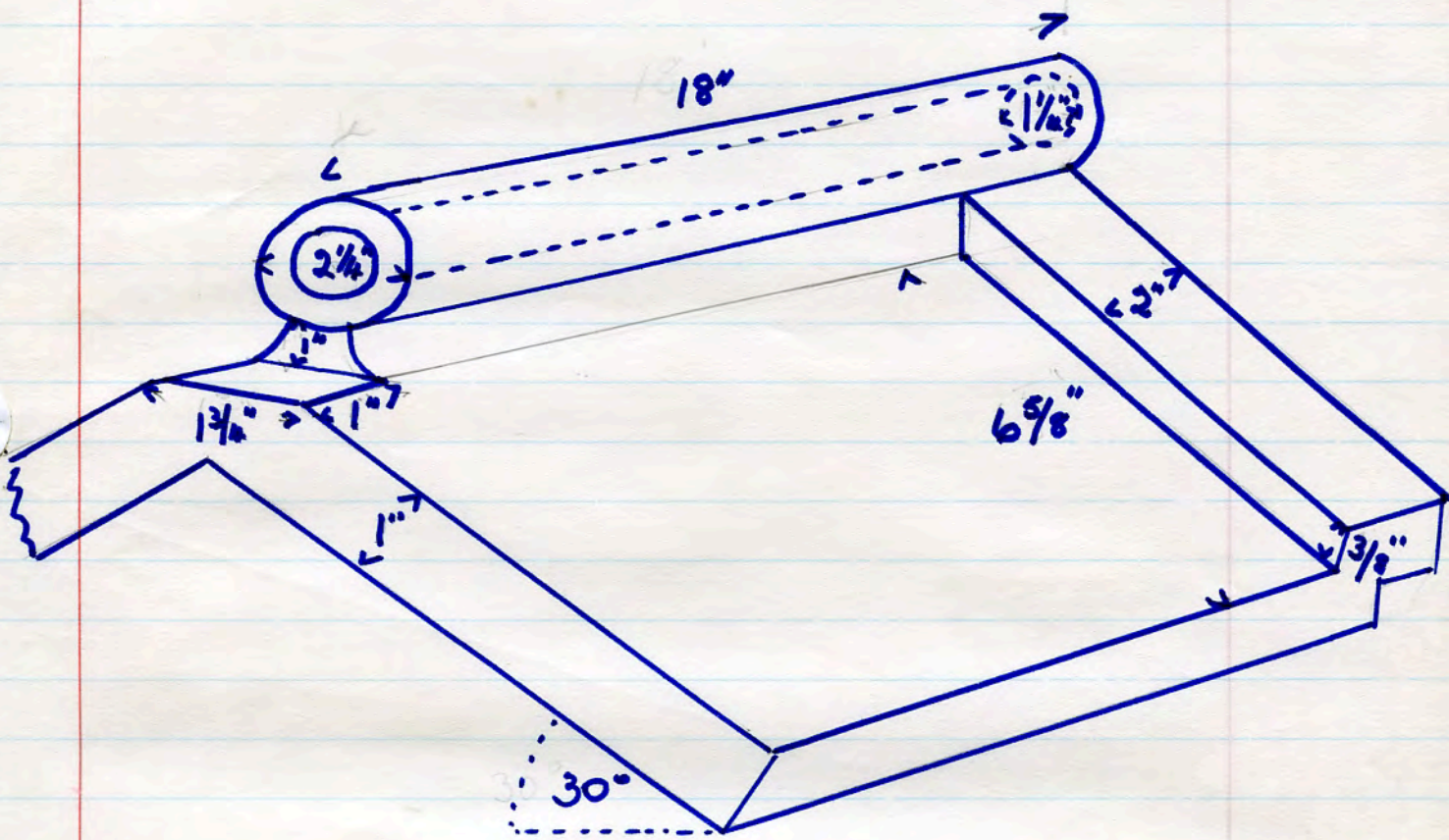
Waterfoot Goods yard (Road express) H. 8. 84



No name. 14 1/2 lbs.
 Y 210 and 
 Trade mark of
 J. S. Edwards,
 Ruabon.

3340

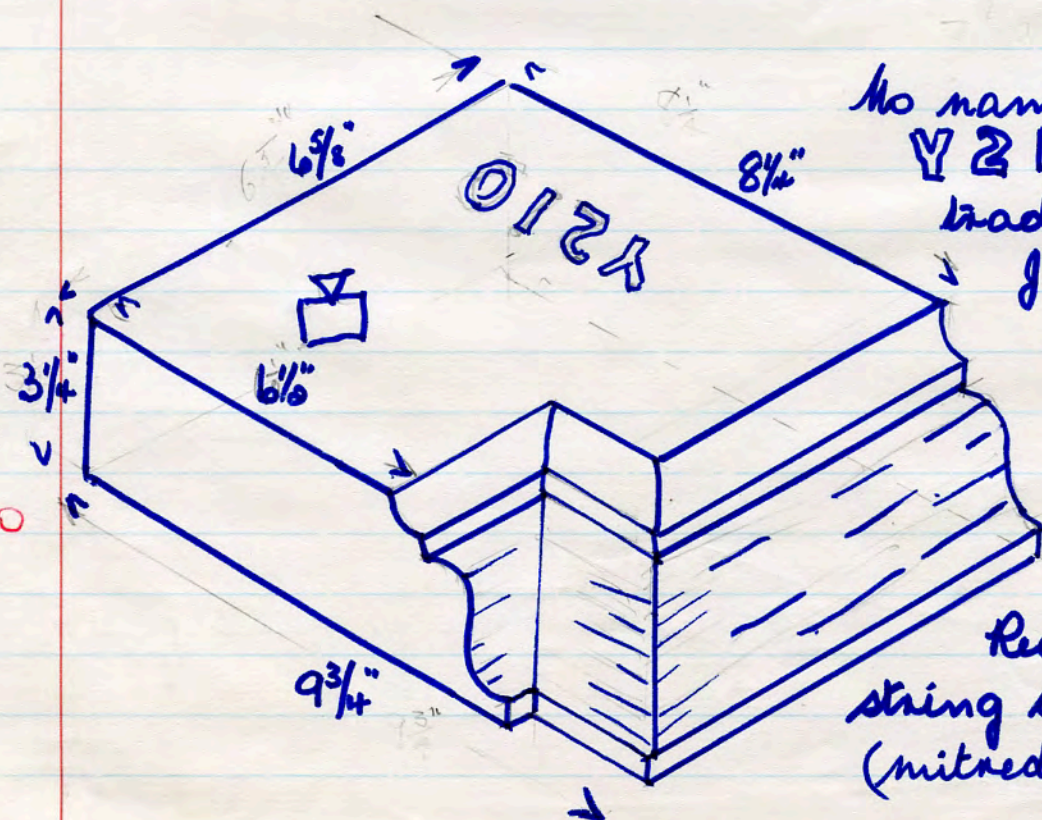

Red T.C decorative
 string course return
 (mitred)

Repairs to Bank, (Barclays) Whitefield 7. 10. 84

No name. Blue ridge tile with 8 ventilation holes
 15 lbs
 on each side
 Dem. of Greyhound Stadium, Turfthorpe, Blackburn

16. 8. 84

3336

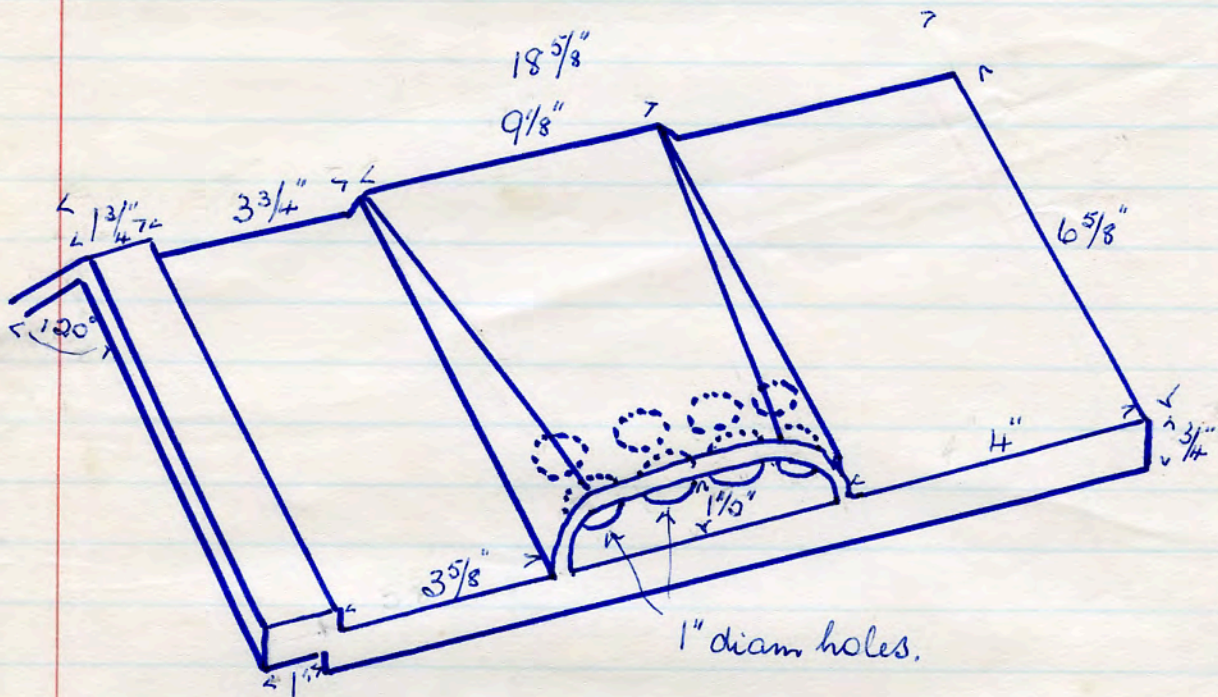

(Wm Brook, Hathershaw 1841)
 W. BROOK dec string
 9 lbs course.
 $8 \frac{5}{16} \times 4 \frac{5}{8} \times 2 \frac{1}{16}$

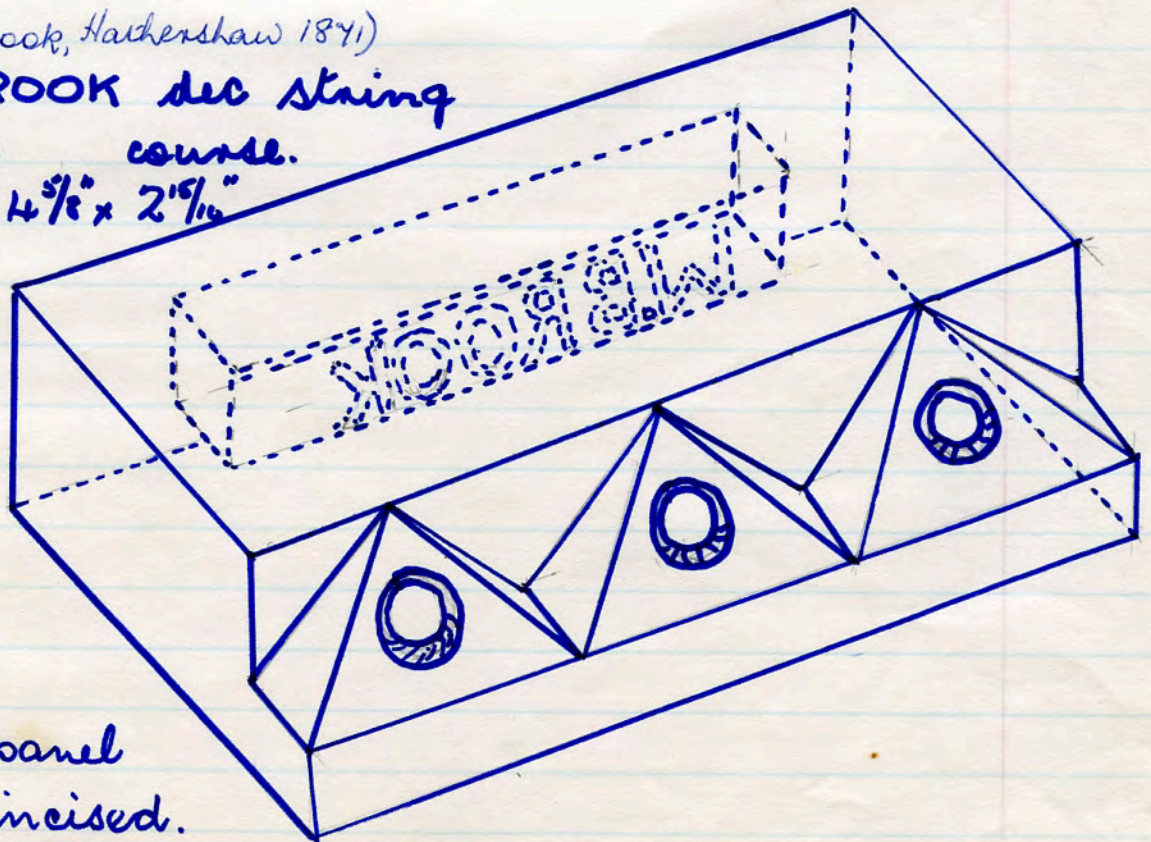

single panel
 letters incised.

Hilfred St dem. Glodwick, Oldham. 15. 10. 84

3349

No name. Salt glazed garden edge tile, dec.
5 lbs. 9 1/2" x 8 1/2" x 7/8" top roll cord 1 1/2" diam.
St James's Villas, Bacup Rd, Waterfoot. 15. 11. 84
peg hole through cord 7/16" diam.

3355



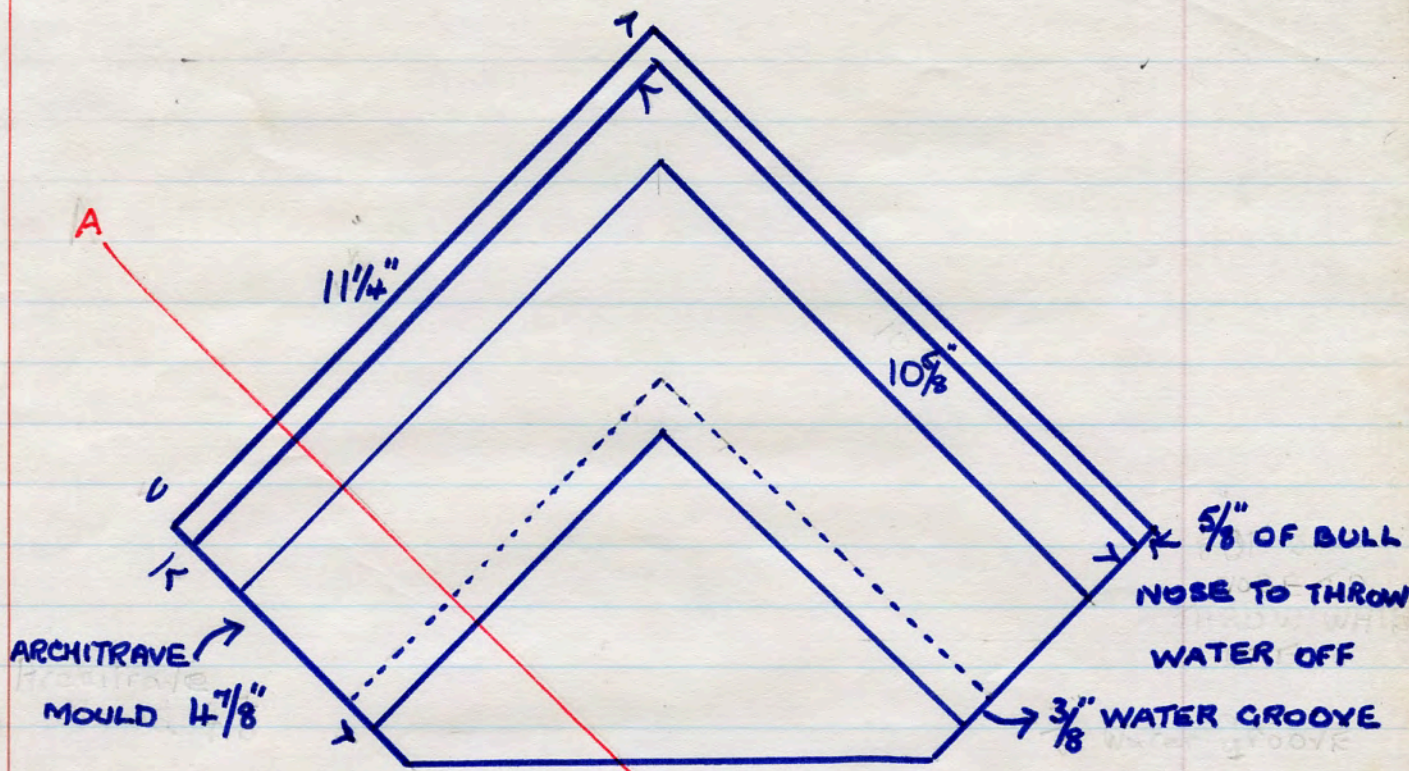

3360

SECTION ON AA

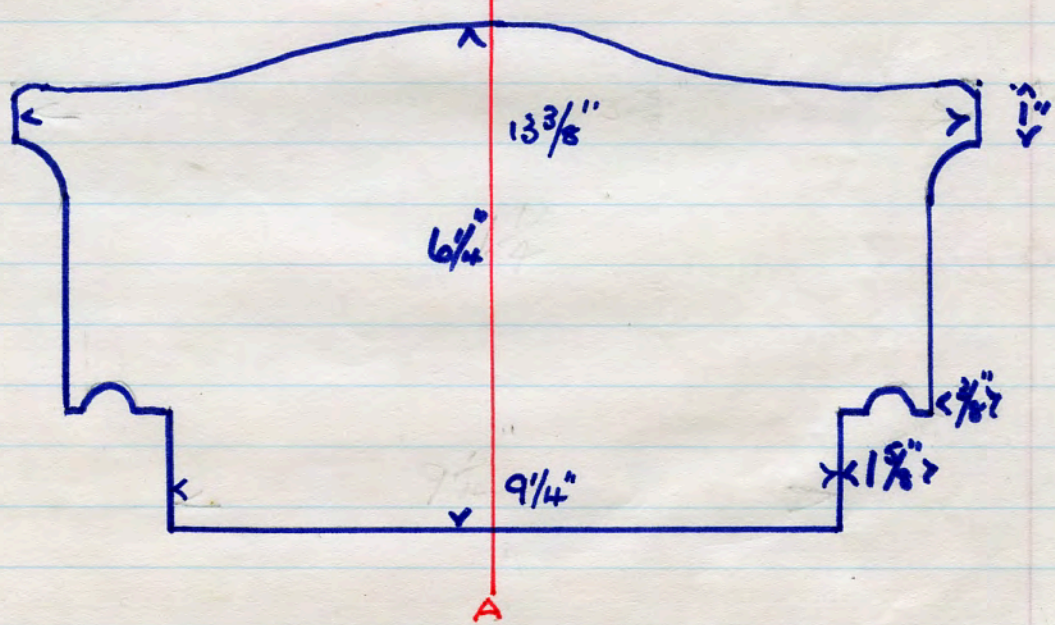

No name. Stone coloured Yema botla apese piece to roof of office at Stanhill Ringmill. V/twistle no Acscington 22. 11. 84.

77 lbs.

3361

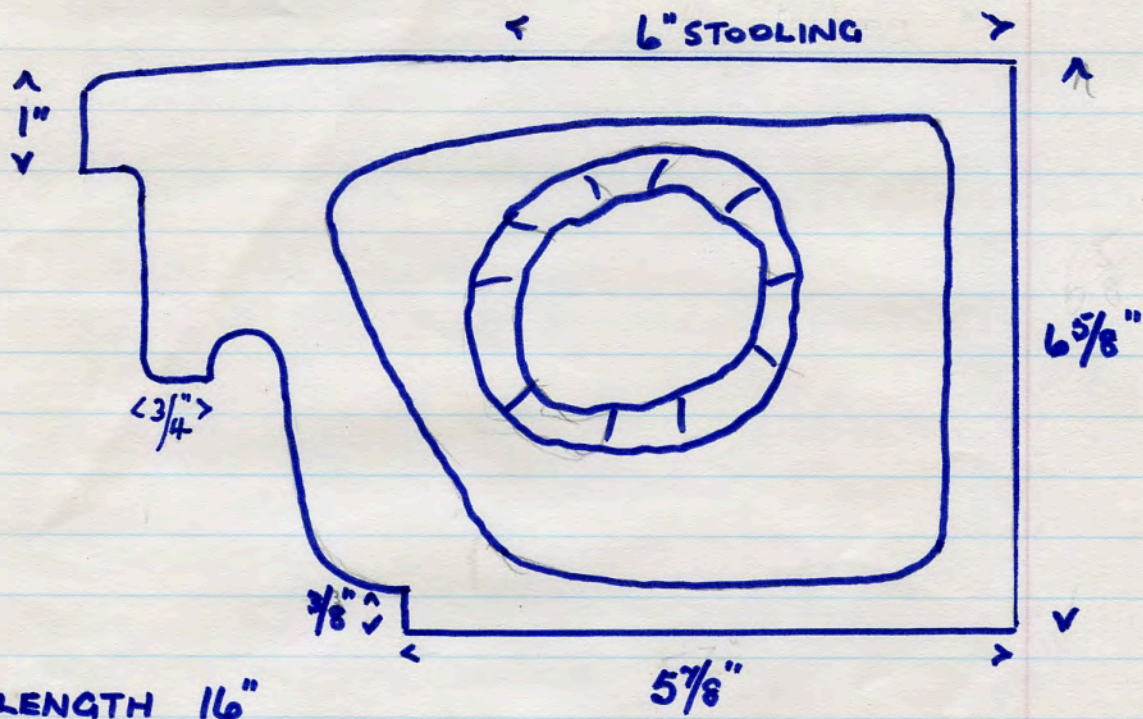

LENGTH 16"

5 7/8"

50 lbs. letters & nos scratched on stooling
 No name. S422. Stone coloured Terra cotta
 staining course. Stanhill Ring Mill. W/twistide nr
 Accrington 23. 11. 84.

No name. POD red
 7 lbs. 8 3/4" x 4 1/8" x 2"
 no panels. wire cut.
 letters stamped on end.

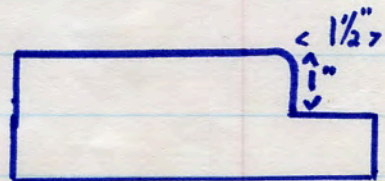

3365

6 x D Bradley, plasterer's yard, Newhall Key Rd. R/stall
 4. 12. 84.

WHEATLEY TRITON MADE IN ENGLAND

quarry tile. heather brown
 3 1/2 lbs. 8" x 8" x 1 1/16"

3368

letters in relief.

6 x D Bradley's, R/stall. 4. 12. 84

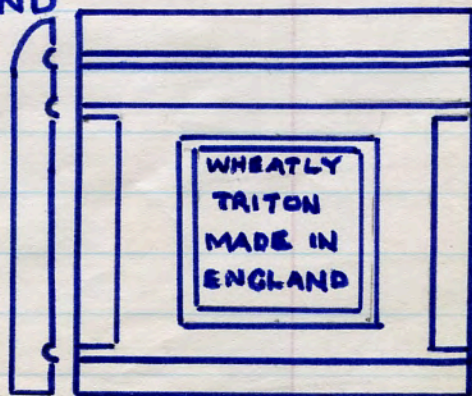

WHEATLY TRITON HEAVY DUTY
MADE IN ENGLAND

heather brown quarry tile

8 lbs. 9" x 9" x 1 1/4"

letters in relief

67 D. Bradley's yard, R/stall.

4. 12. 84

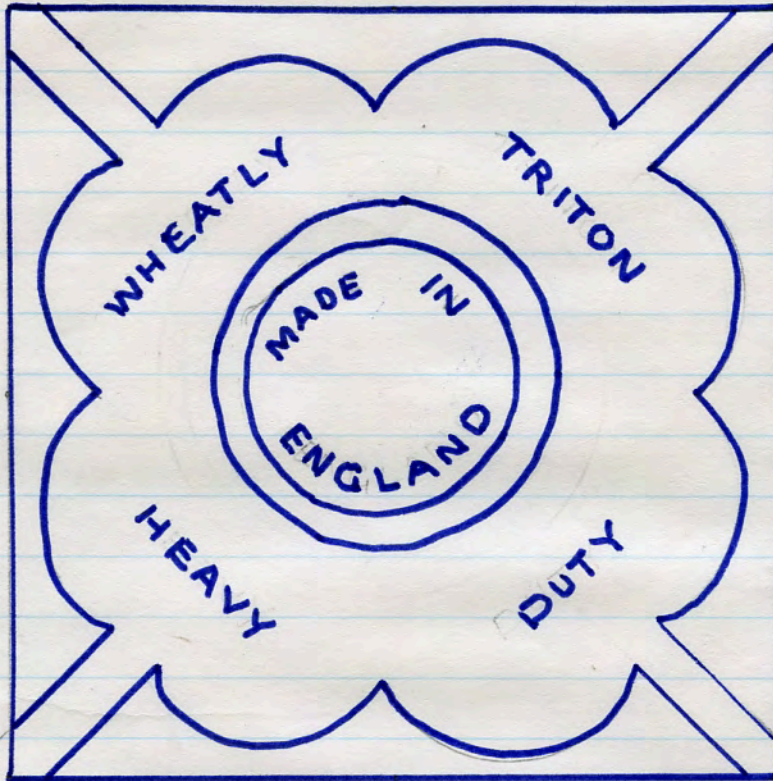

DENNIS
RUABON

MADE IN
WALES

HEATHER BROWN

MADE IN
WALES

DENNIS RUABON
MADE IN WALES
HEATHER BROWN

quarry tile, heather brown

7 1/2 lbs 9" x 9" x 1 3/16"

letters in relief

67 D. Bradley. R/stall.

4. 12. 84

3370

Pinnacle from
Alder Mill,
Leigh
Buff terra
cotta made
by Bispham
Hall Brick
Works.

splits into
3 pieces.

3372.-

bottom left



3374, capping.

3373 - bottom right.

No name. AM 3 scribed on one end AM 92 on opposite
 2 cavities for reinforcing. (finger scraped). end.
 23 lbs. $9\frac{3}{4}" \times 9" \times 4\frac{7}{8}"$

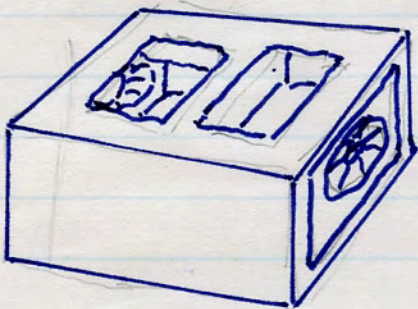

AM 871 scribed on base. 46 lbs. 1 large cavity.

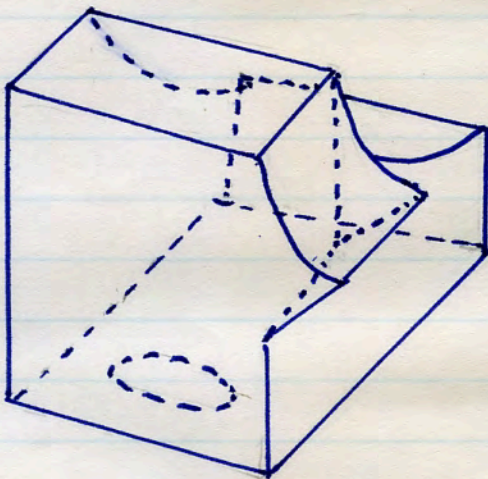

No name. no number. 35 lbs $9" \times 9" \times 9"$
 Decorative rapping with moulds.

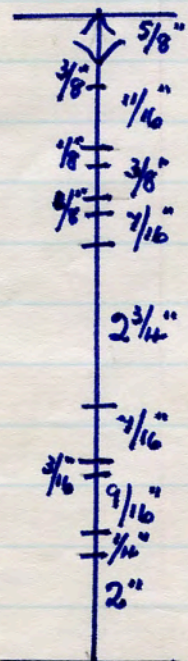
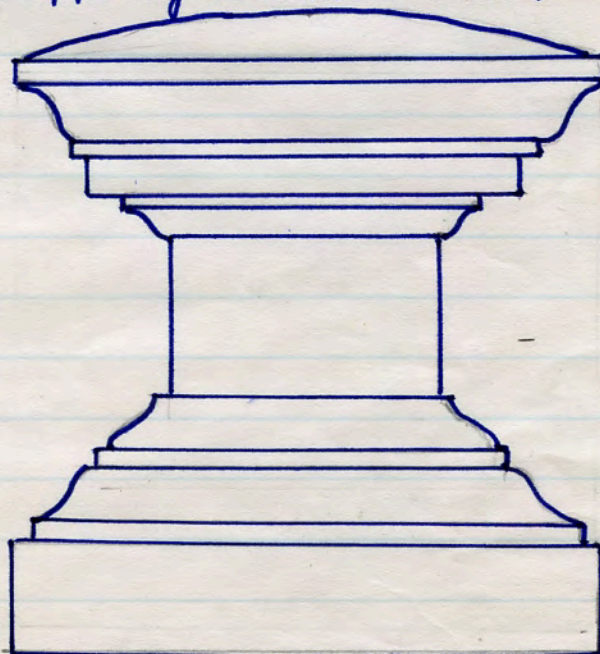

3372.

3373.

3374.

No name. (presumed Monk; Newell)
red stretcher. Sestia mould. T.C.
part of NO 2249.

8 1/2 lbs. 9" x 4 3/8" x 3 1/4"

single panel in top.

attached to pilaster head - Fernell St dem. M/v. 24. 8. 80.

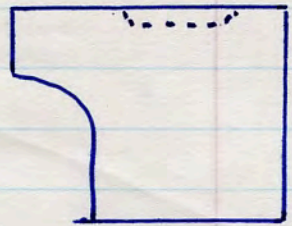

1/4 70 lbs

SO 260 Stone coloured terra cotta bottom kneeler to
office at Stanhill Ring Mill, W/twistle. nr Accrington
to accompany No 3360. apex piece 14. 3. '85

70 lbs. ex Tomfield Brick + Terra cotta Co Ltd
water groove all round

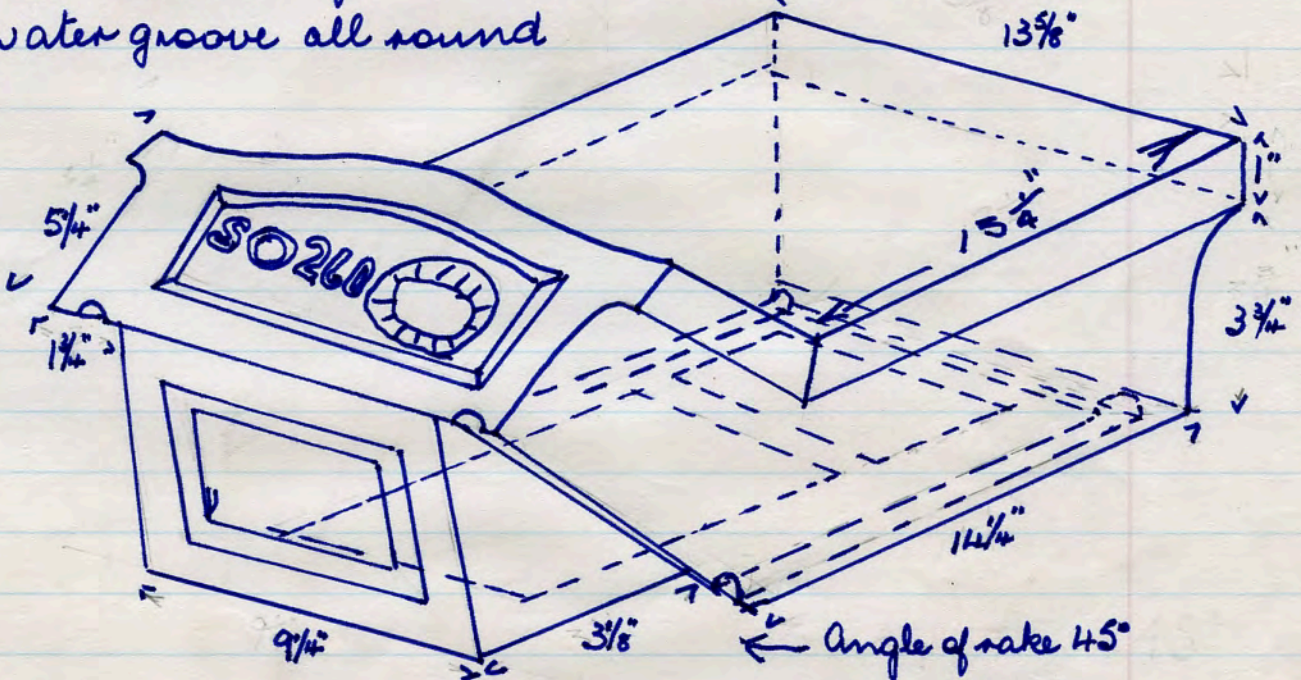

No name

7 lbs. 9" x 5 5/8" x 2 1/2"

1" x 1" nosed groove.

Wine run ex Tomfield B-T.C. Co. Ltd
red T.C window sill piece
Stanhill Ring Mill, W/twistle
nr Accrington 14. 3. '85

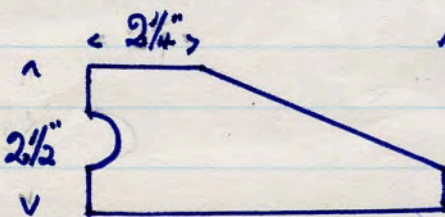

These are sometimes built up to cover a cavity.



CADDICK 

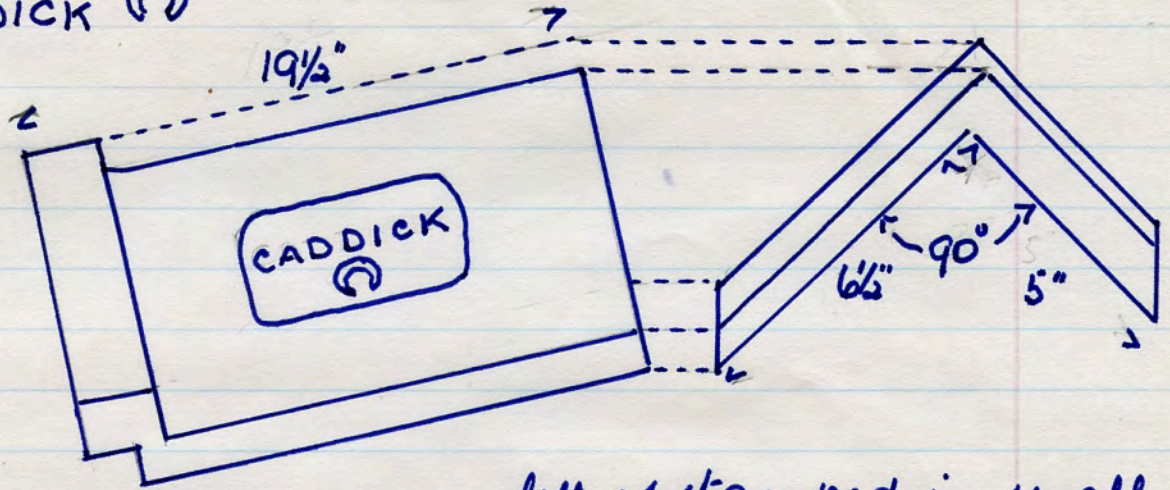

3383.

letters stamped in small blue ridge tile for North light roof. panel one side.

.17 lbs 19 1/2" long. sides 7/8" thick.

14. 3. '85

North East lanes Co-op Laundry. 10/twistle, in Acc/ton

No name. decorative paver. dark red.

7 1/2 lbs.

Winfield's Stone, Acce. Haslingden. 28/3/85.

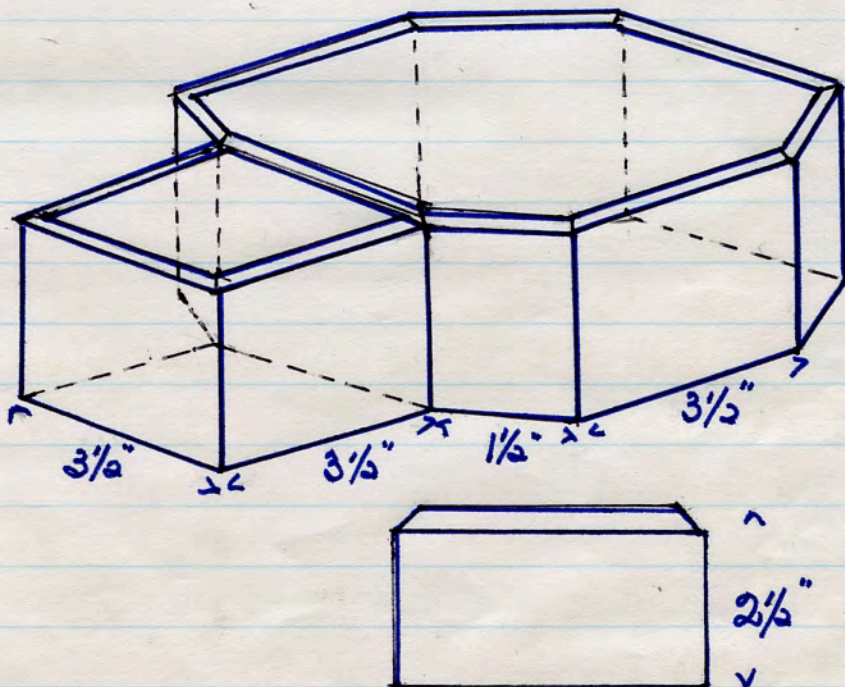

3384

Section showing chamfer all round the face edges.

No name. red wall cap.

10 lbs. 11" x 6³/₄" x 2³/₄"

single panel one side only. plain rev.

Rose Hill dem site. Bolton. 21. H. 85.

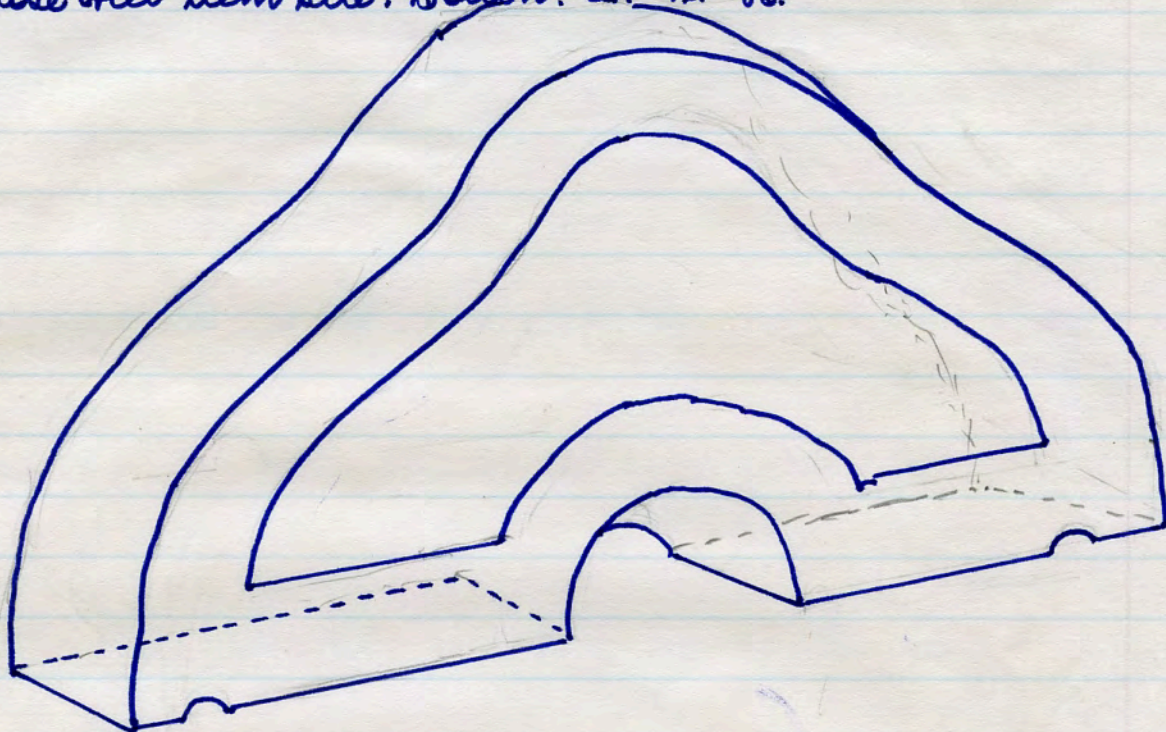

3387.

No name. blue wall cap.

10 lbs. 12" x 6¹/₄" x 3⁵/₈"

no panels.

Lever St dem. Bolton. 21. H. 85.

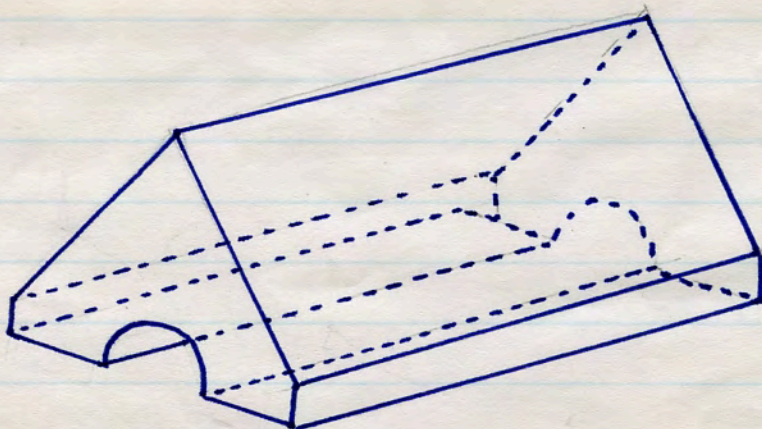

3388

No name EZ 276 red terra cotta ^{scotta} moulded return
 8 1/2 lbs. 7 1/2" x 7 1/2" x 3"

letters stamped.

Will have spinning too dem. Leigh 6. 5. '85

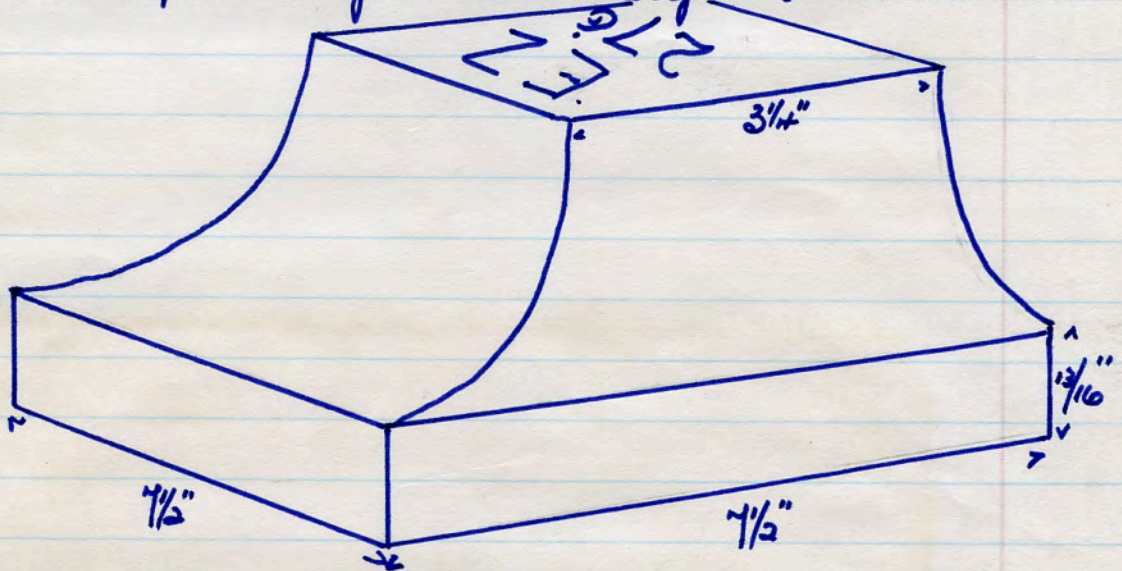

3400

No name EZ 272 red terra cotta, moulded (1/4 mould)
 mixed return.

12 1/2 lbs 9" x 6 7/8" x 3/8"

letters stamped

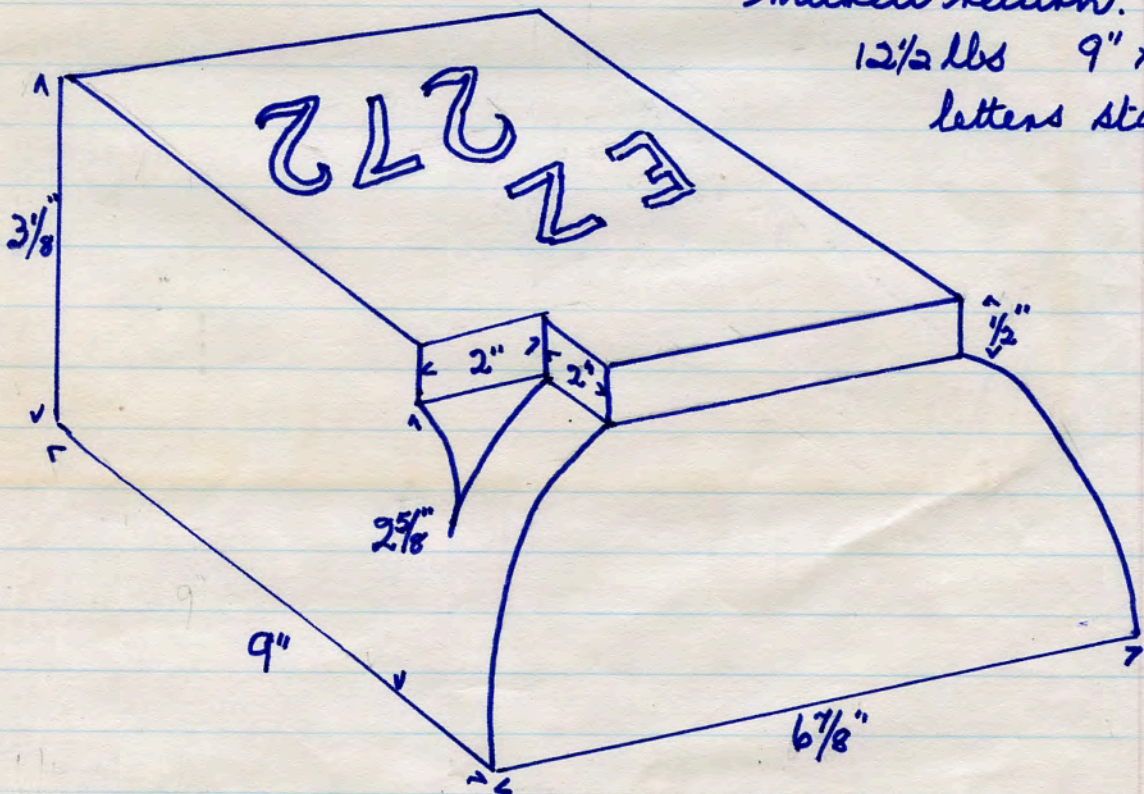

3401

Will have spinning too dem. Leigh. 6. 5. 85.

No name. EZ 10 decorative red terra cotta

70 lbs. panel in 1 end. letters stamped.
Mill Lane spinning loo dem. high 6. 5. 85.

3402

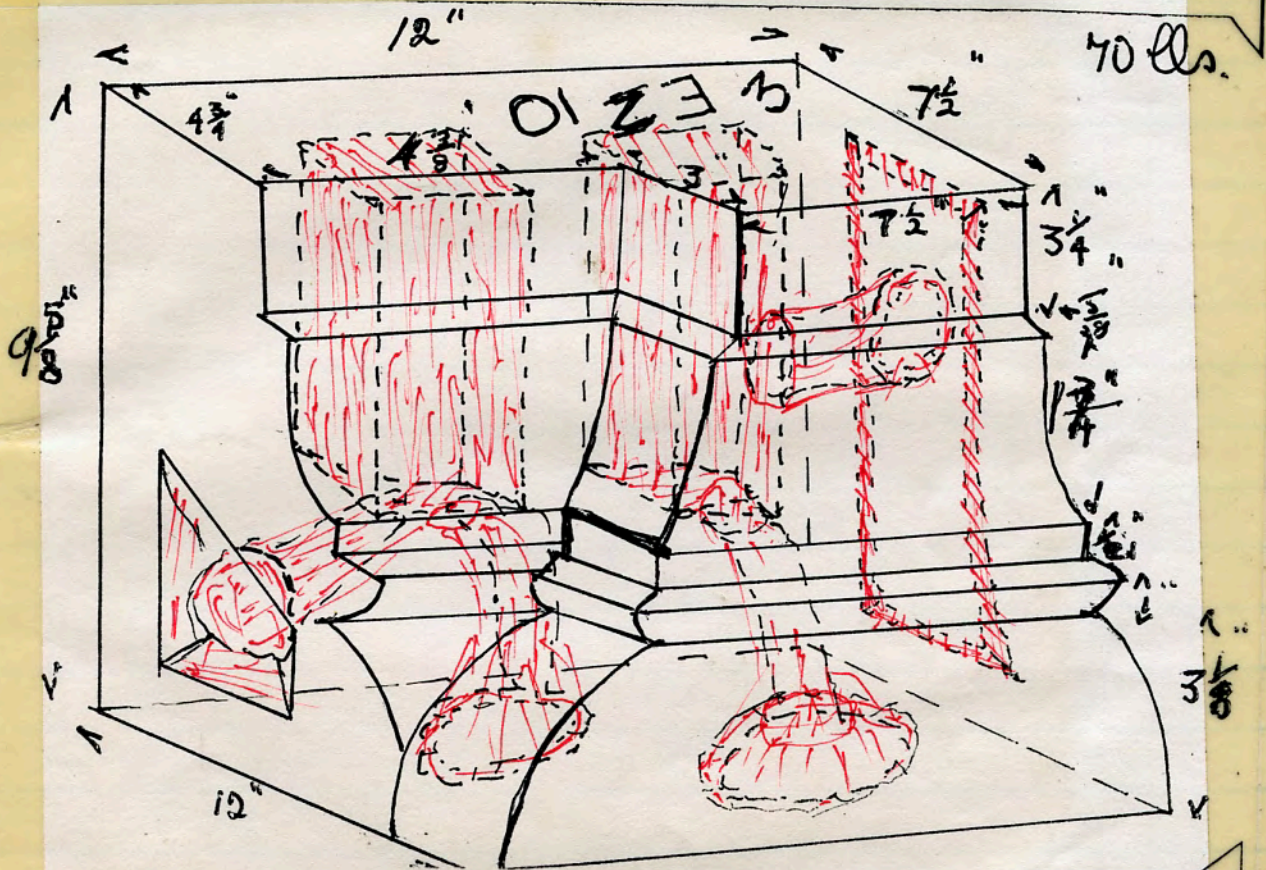

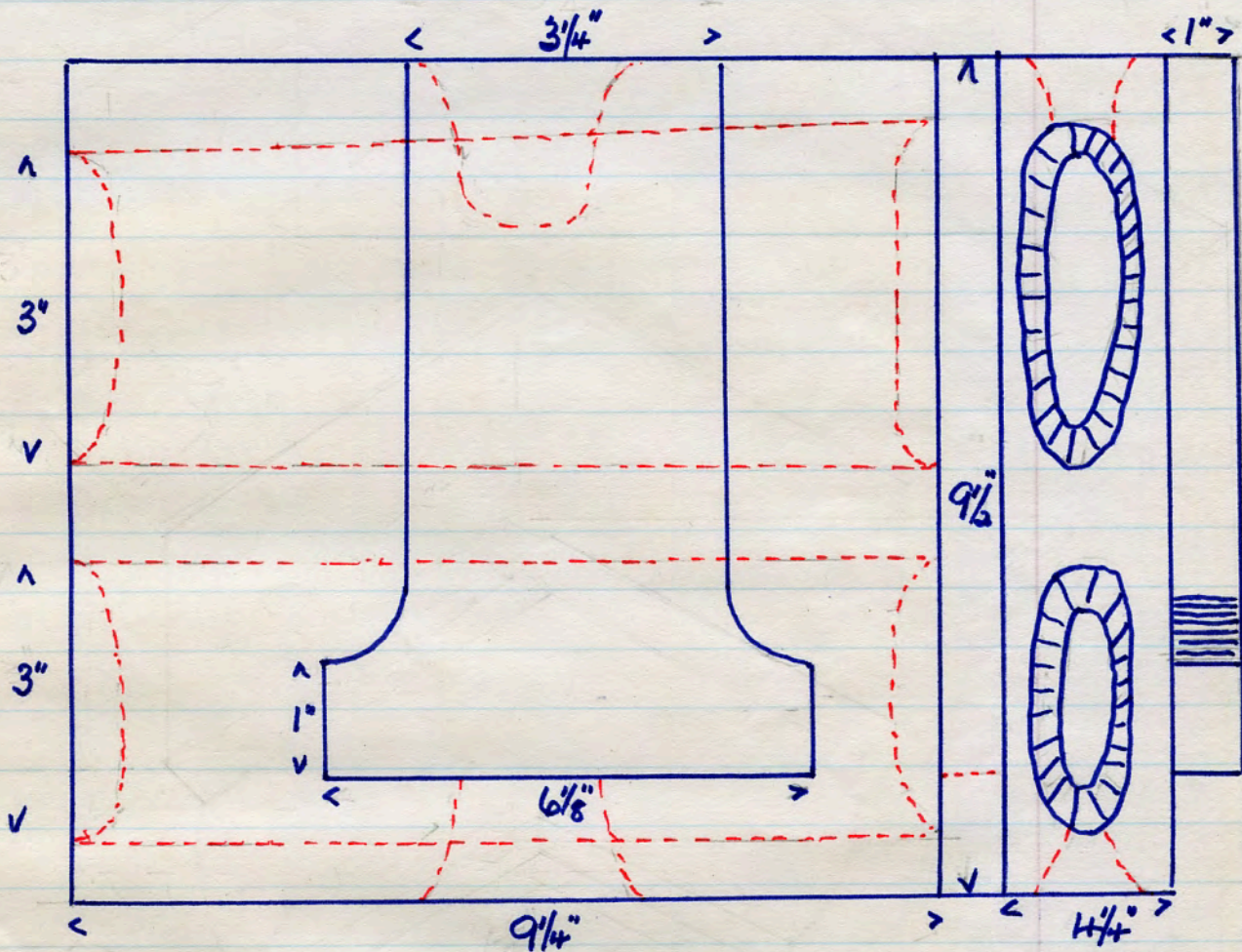

No name (Accrington) EZ 54 red terra cotta.
 28 lbs. (lower part of letter I in MILL)
 No panels. letters stamped. 4 perfs.
 Mill Lane spinning Co Ltd. dem. Leigh. 12. 5. 85.

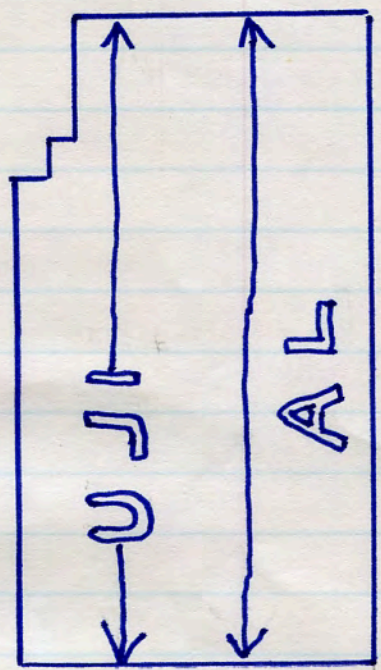
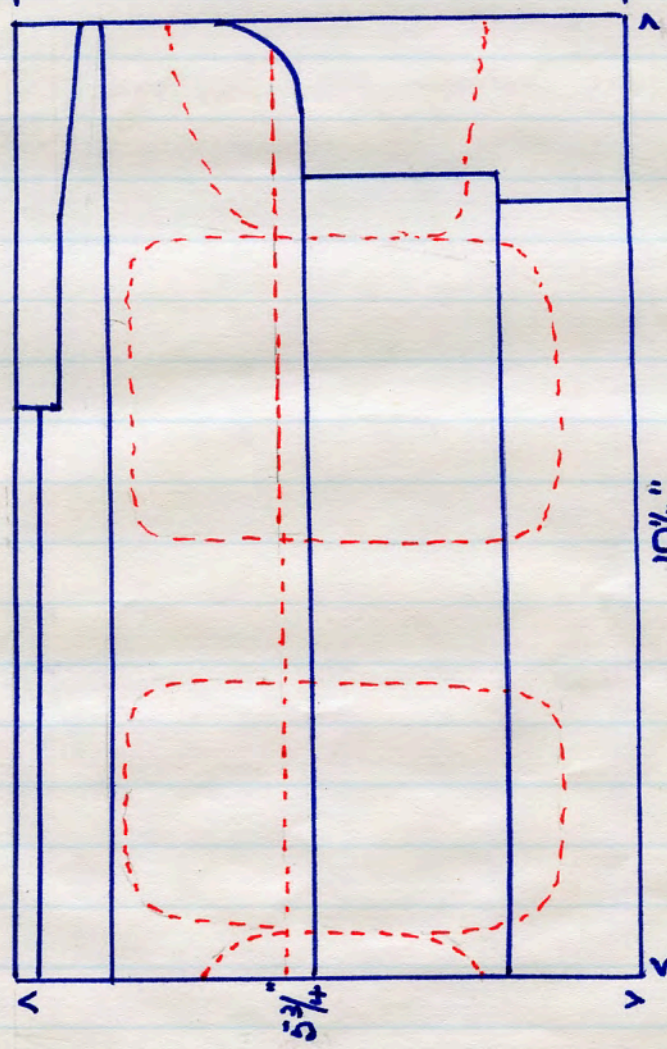
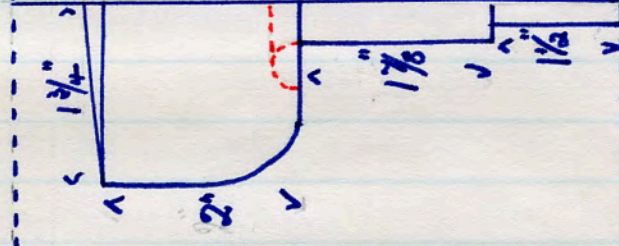
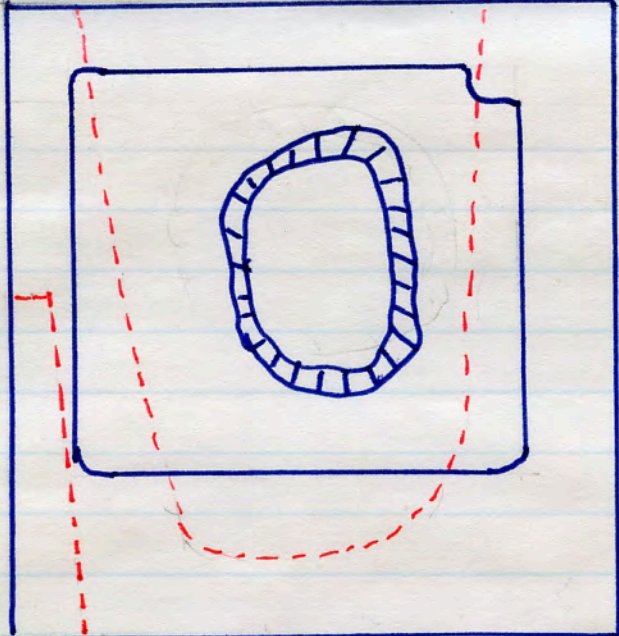

Marks on base.

3412

No name. UJI AL buff T.C. cill corner with
 stoling, and return mould with water drip.
 28 lbs. Single panel each end and base. 1 perf each end
 and 2 in sev. Broadbent's Foundry dem. Ashton u. Lyne 12. 5. 85

No name. EZ 150 red terra cotta Scotia mould return
 23 lbs 13" x 8 1/2" x 3" single panel each edge.

letters stamped
 10 holes 1/4" diam.

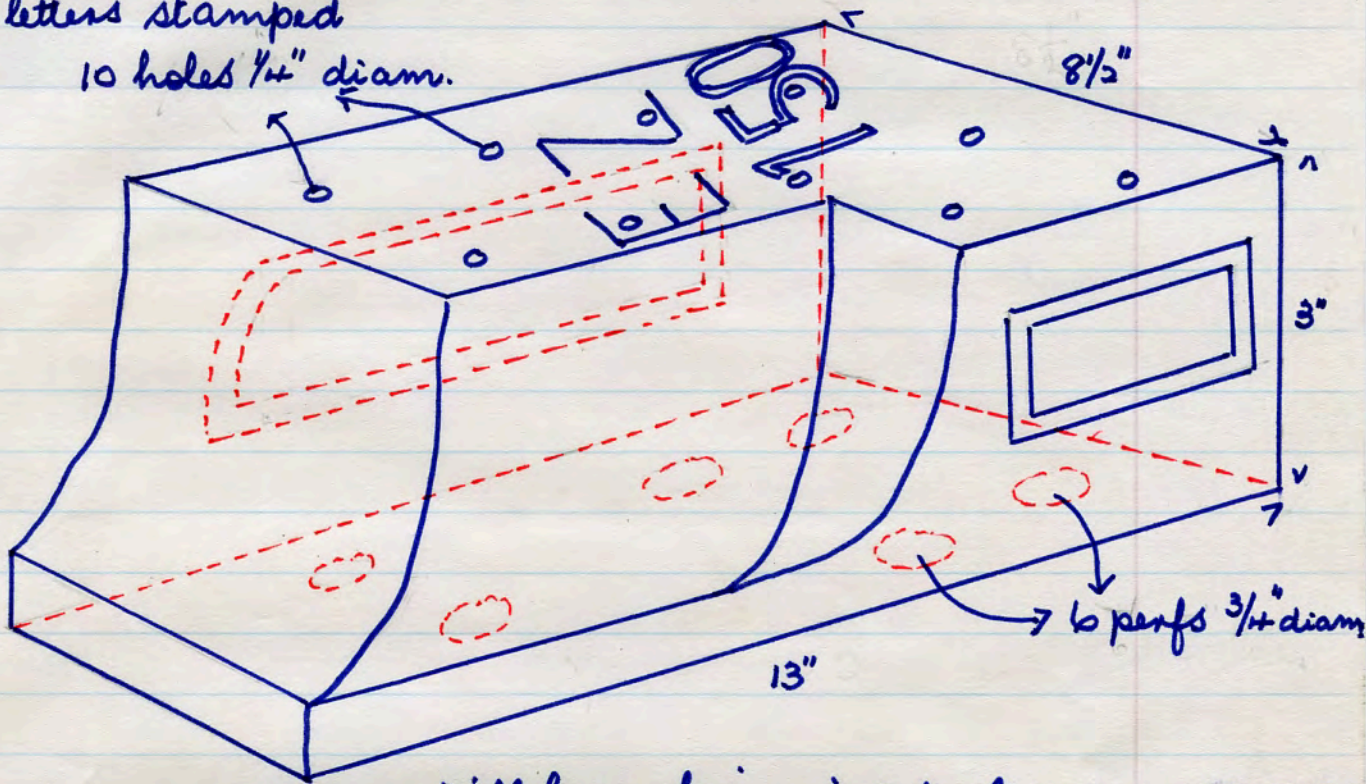

Mill Lane spinning Co Ltd dem 19. 5. 85
 Leigh

No name. EZ 196
 red, bonding stretchers
 9 lbs or Reveal Book
 9 1/8" x 4 3/8" x 3 1/8"
 single panel 1 side
 letters stamped.

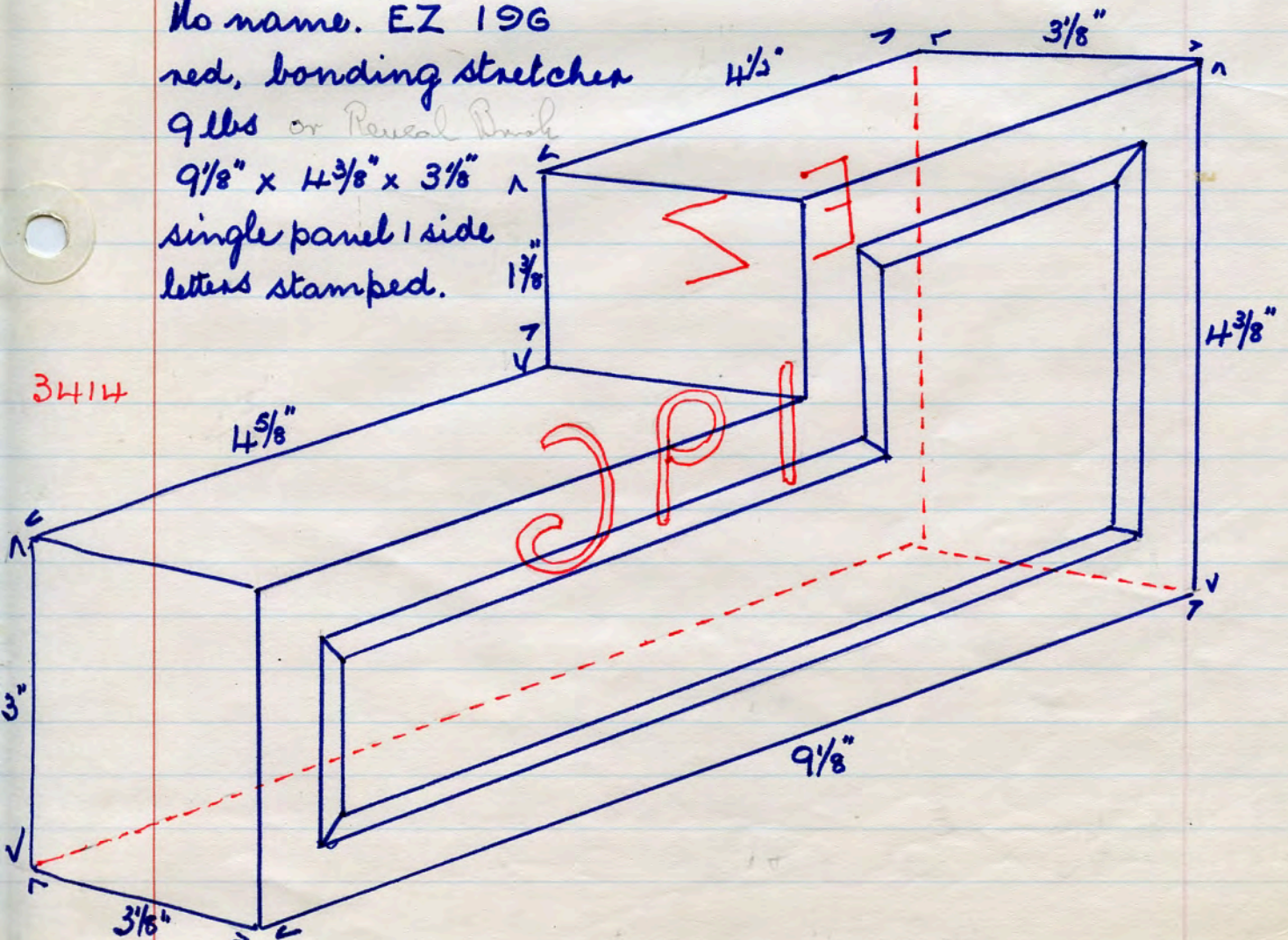

No name. EZ 98 red terra cotta
 38 lbs $12\frac{7}{8}" \times 9\frac{1}{2}" \times 4"$
 no panels. letters stamped

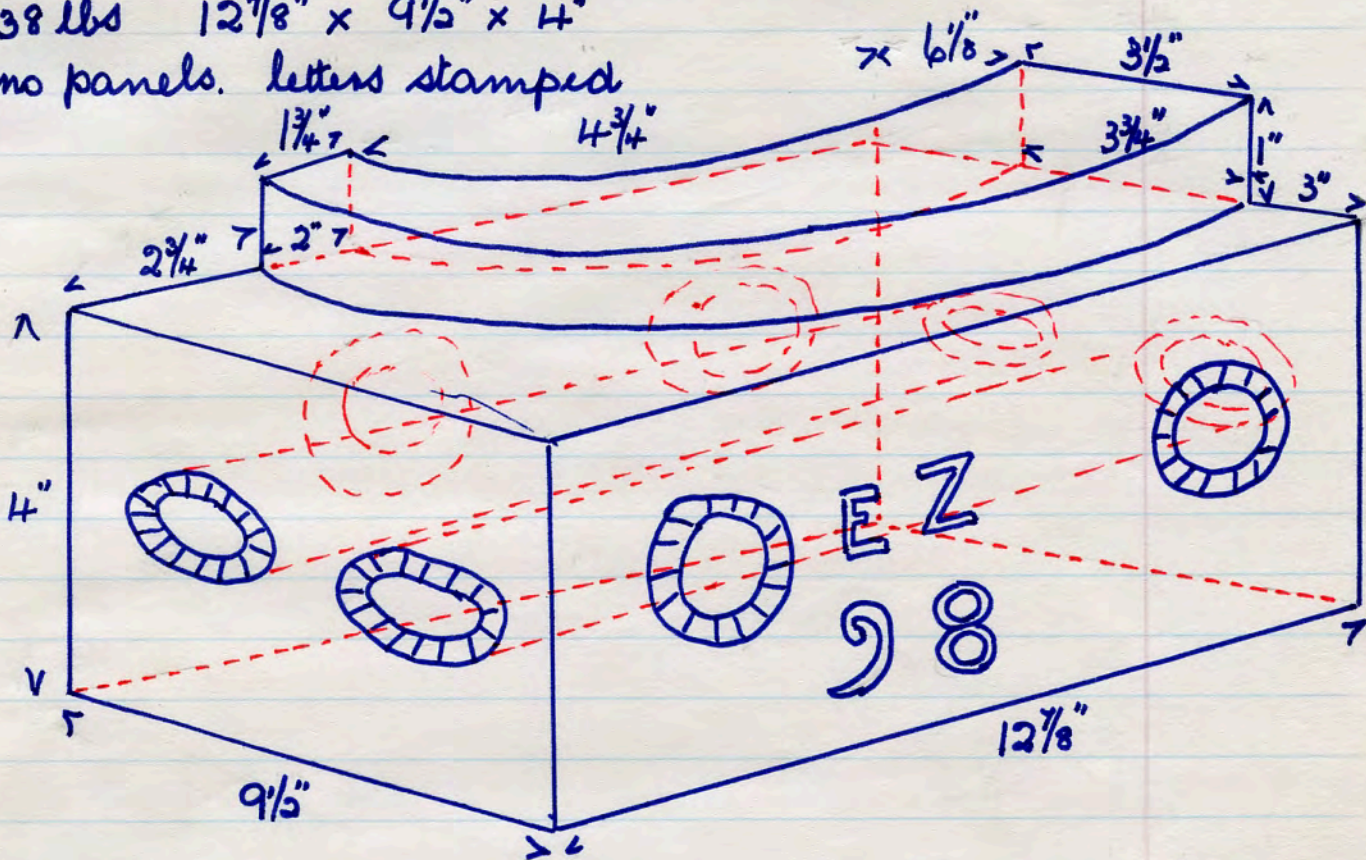

part of curved letter in name of mill
 4 perfs = 2 longitudinal from end to end. and
 4 " only part way through.
 Mill Lane Spinning Co Ltd. Leigh. dem 19. 5. 85.

No name. red clay ventilator brick.
 4 lbs. $9\frac{1}{8}" \times 3\frac{7}{8}" \times 3\frac{1}{8}"$

3 small panels $3" \times 3\frac{7}{8}"$ each with flower in relief.
 centre flower pierced.
 cavity $6" \times 2" \times 3"$ in rev.

House dem. Back Derby St. Daubhill, Bolton 2. 6. 85.

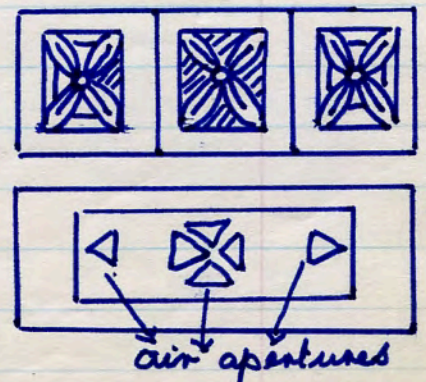

No name. EZ 101. red terra cotta.
 40 lbs. $13\frac{3}{4}" \times 9\frac{1}{2}" \times 4\frac{1}{8}"$. no panels. letters stamped.
 part of letter in name of mill,

3426

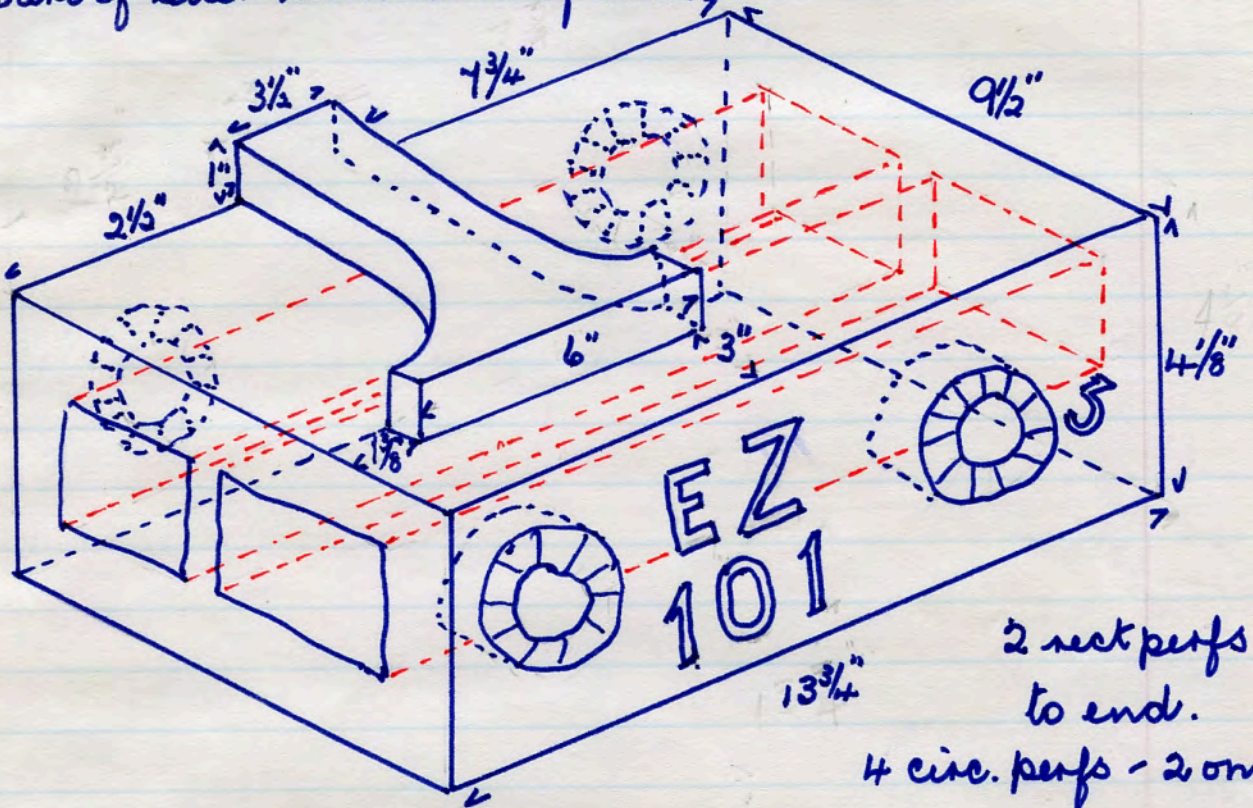

2 rect. perms end to end.
 4 circ. perms - 2 on each edge.

No name. 13
 red terra cotta
 $12\frac{1}{2}$ lbs

3427

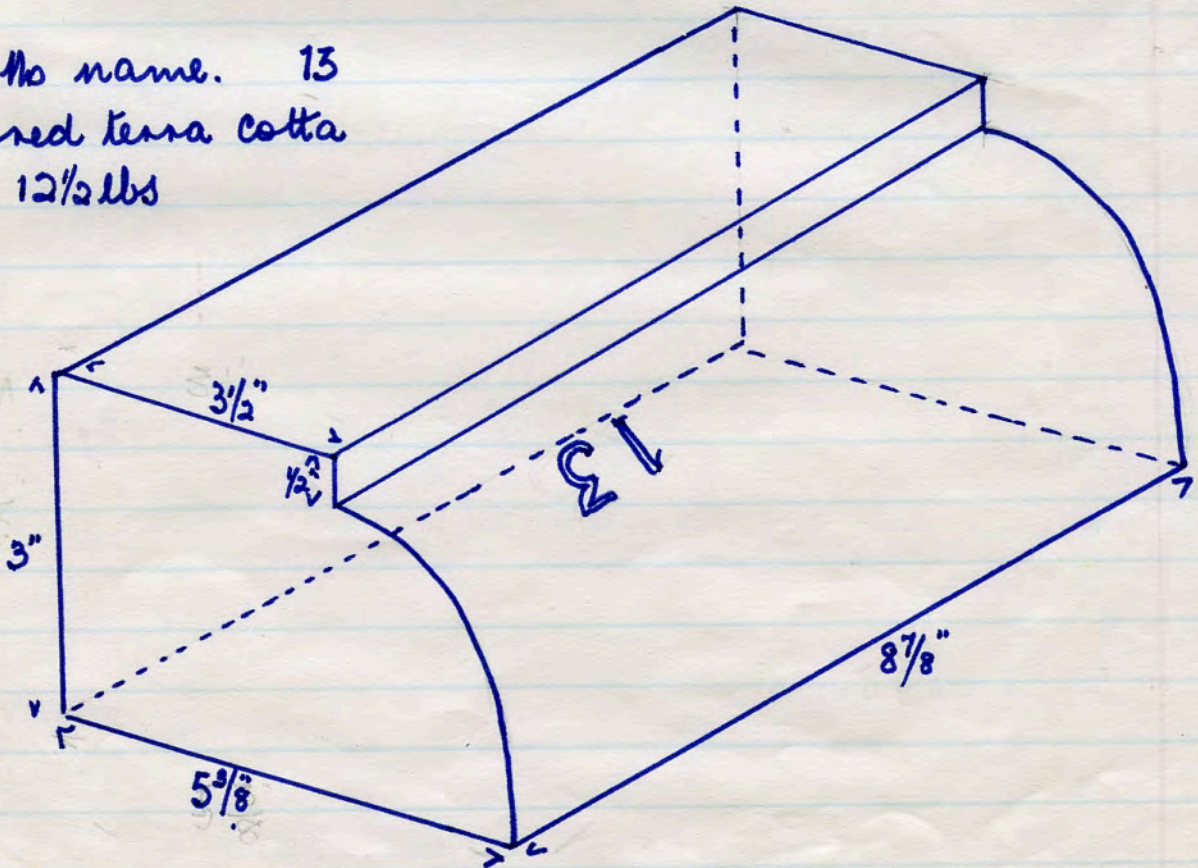

string course mould. no panels. number stamped.
 Mill Lane Spinning Co. Ltd. Leigh. dem. 9. 6. 85.

ACCRINGTON NORI EZ 194 red terra cotta sill piece

9 lbs.

9" x

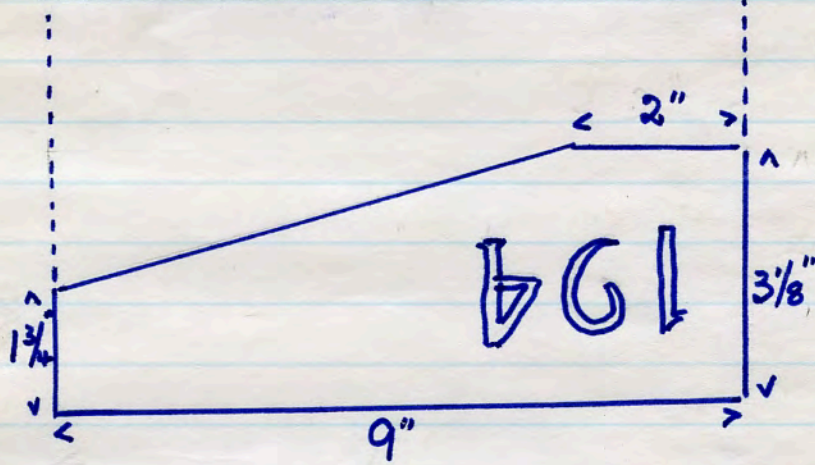
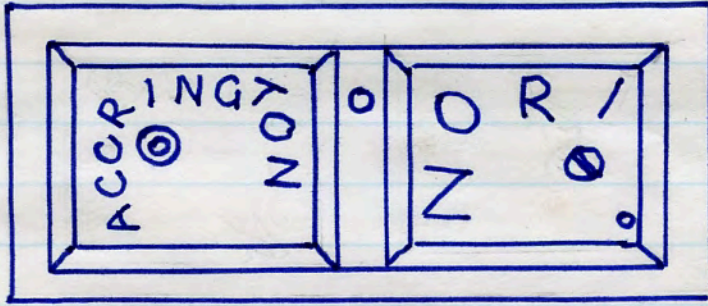

EZ stamped on opposite side

3428

Mill Lane Spinning Co Ltd, Leigh (dem) 9. 6. 85.

No name. EZ 154 red terra cotta rebated brick to match the square angled design.

7 lbs. $7\frac{3}{16}$ " x $4\frac{1}{4}$ " x 3"

single panel 1 side only
letters + numbers stamped opposite side.
Mill Lane Spinning Co Ltd, Leigh (dem)

16. 6. 85

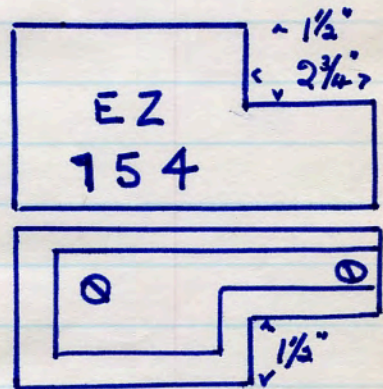

3429

No name. EZ 17G similar piece to 3429.

13 1/2 lbs. $9\frac{3}{8}$ " x $6\frac{3}{4}$ " x 3"

single panel 1 side only
letters + numbers stamped opp. side
Mill Lane, Leigh (dem). 16. 6. 85

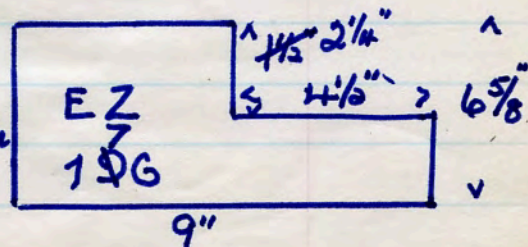

3430

ACCRINGTON NORI B & T CO LD 3

EZ 178 red terra cotta rebated brick to match square angled design.

13 lbs. $9\frac{7}{8}'' \times 5\frac{5}{8}'' \times 3''$

single panel 1 side only
letters & numbers stamped opp. side
Mill Lane Spinning Co. Ltd. Leigh.
dem. July 1985.

3431

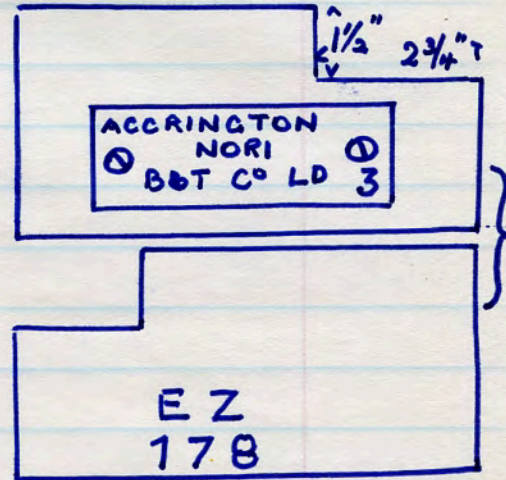

No name. EZ 177 red terra cotta rebated brk.
10 lbs $7\frac{1}{4}'' \times 6\frac{1}{2}'' \times 3''$ similar to 3429 + 3430.

single panel 1 side only
letters & numbers stamped opp. side
Mill Lane Spinning Co Ltd Leigh
dem. July. 1985

3432

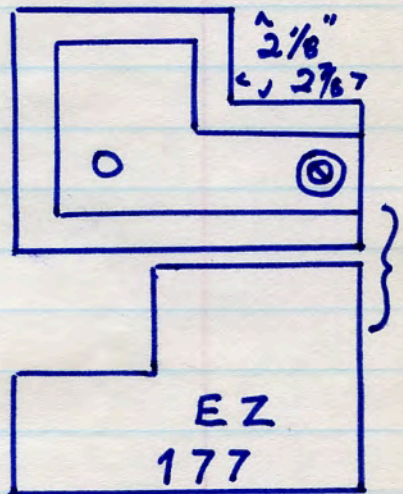

No name. EZ 183 red terra cotta rebated brk.
with water groove $\frac{3}{4}''$ wide Fincised (front).

13 lbs. $7'' \times 8\frac{7}{8}'' \times 3''$

4 perfs $\frac{3}{4}''$ diam. $\frac{1}{4}''$ deep in row.
letters & numbers stamped
Mill Lane Spinning Co Ltd. Leigh
dem. July 1985.

3433

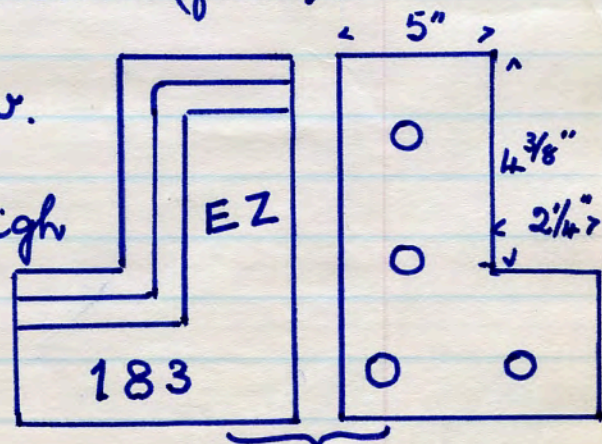

No name. EZ 180 red terra cotta rebated brk
 18 lbs. $10\frac{1}{2}'' \times 7\frac{3}{8}'' \times 3''$

single panel $6\frac{1}{4}'' \times 3\frac{1}{4}''$. one side only
 letters and numbers stamped in panel

4 perfs $\frac{3}{4}''$ diam. $\times 1\frac{1}{4}''$ deep in rev.

Mill Lane Spinning Co Ltd. Leigh
 dem. July 1985.

3434

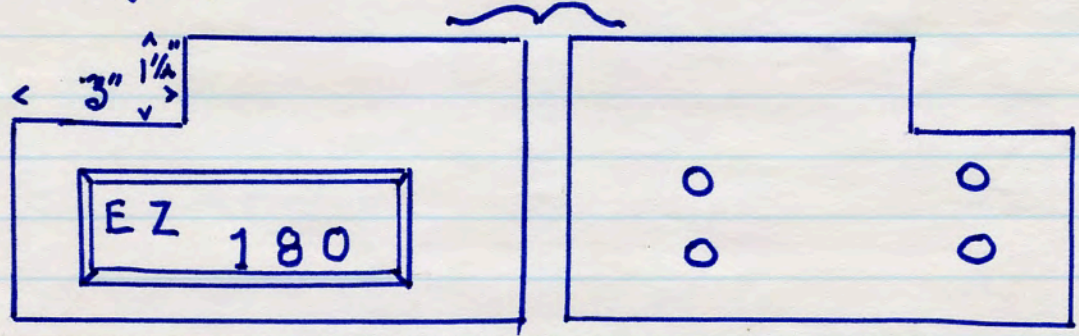

No name EZ red terra cotta rebated brk.

8 lbs. $8\frac{3}{4}'' \times 4\frac{1}{4}'' \times 3''$

no panels

letters stamped 1 side only.

Mill Lane Spinning Co Ltd. Leigh
 dem. July 1985.

3435

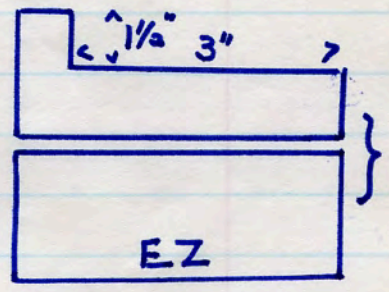

ACCRINGTON NORI EZ1 red T.C chamfer piece.

13 lbs. $9'' \times 5\frac{3}{4}'' \times 3\frac{1}{8}''$

double panel in base.

letters incised.

EZ1 stamped obv.

Mill Lane Spinning Co Ltd. Leigh.
 dem. July 1985.

3436

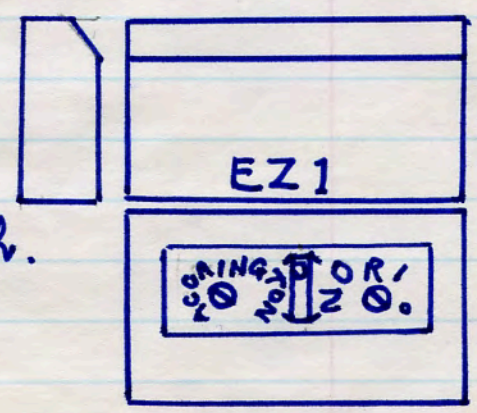

No name EZA red T.C. gauged & chamfered.
8 1/2 lbs. 8 3/8" - 7 3/4" x 4 1/8" x 3"

single panel in rev.

letters stamped obv.

3437

Mill Lane Spinning Co Ltd Leigh.
dem. July 1985.

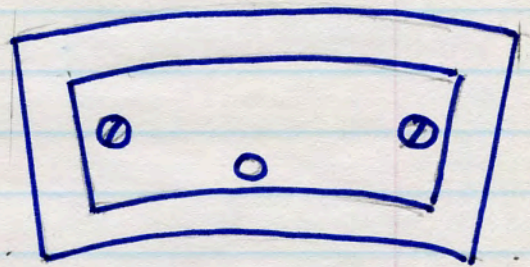
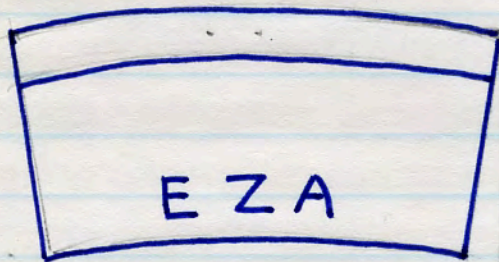

No name 21 red T.C. header with scotia mould.
8 1/2 lbs. 9" x 4 1/2" x 3"

no panels. numbers stamped

Mill Lane Spinning Co. Ltd. Leigh
dem. July 1985

3438

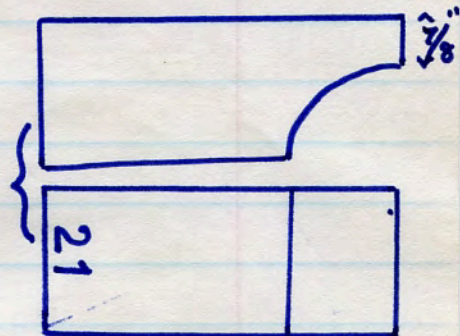

No name. red T.C. header with water groove 3/4"
10 lbs. 9 7/8" x 4 3/8" x 3"

single panel in rev.

Mill Lane Spinning Co Ltd. Leigh
dem. July 1985.

3439

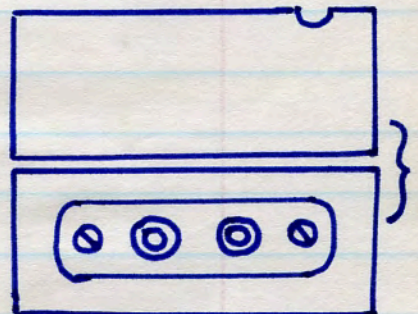

No name. EZ 164 red T.C. right < Scotia return (right)
12 1/2 lbs. 8" x 6 3/4" x 3" (left)

no panels.

letters & nos. stamped on base.

Mill Lane Spinning Co. Ltd. Leigh
dem. July 1985.

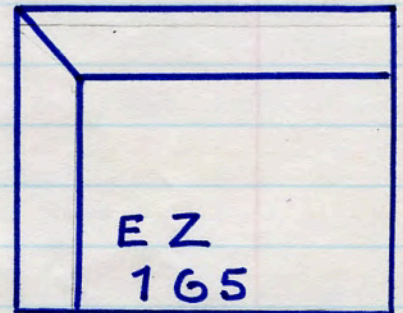
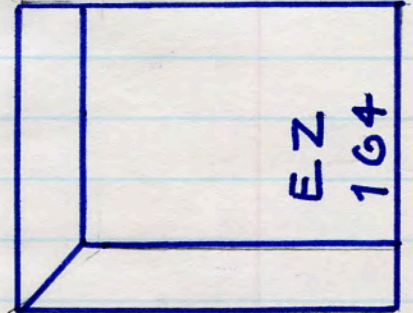
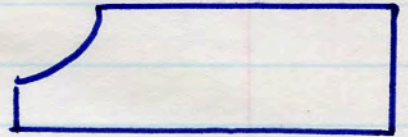

As above, but left hand

3441

No name. EZ 55 red T.C. dec.

10 lbs 4 1/2" x 4 1/2" x 6"

no panels. letters etc stamped

large cavity in rear 4" x 2 1/4" x 4 1/4"
cone shaped perf. top & bottom 1 1/2" - 3/4"
dec. on front protrudes 1 1/2".

3442. Mill Lane Spinning Co. Ltd. Leigh
dem. July 1985

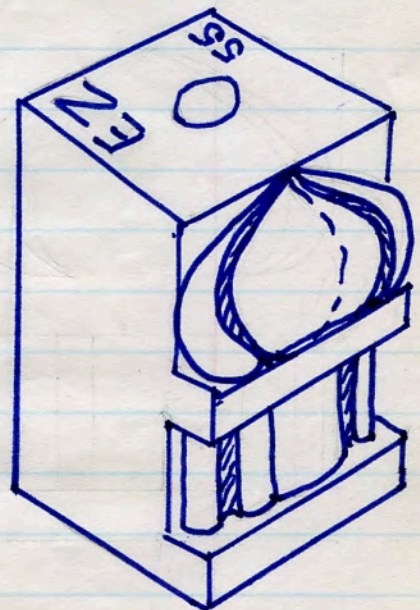

No name EZ. red T. C.

12 lbs $4\frac{1}{2}'' \times 4\frac{1}{2}'' \times 6''$
dec. protrudes $1\frac{1}{2}''$ on
two sides

3443.

no panels. letters stamped
scoped cavity in base
 $3'' \times 3''$.

3 perfs. (top + 2 sides) which
enter cavity.

Mill Lane Spinning Co. Ltd
Leigh. dem. July 1985

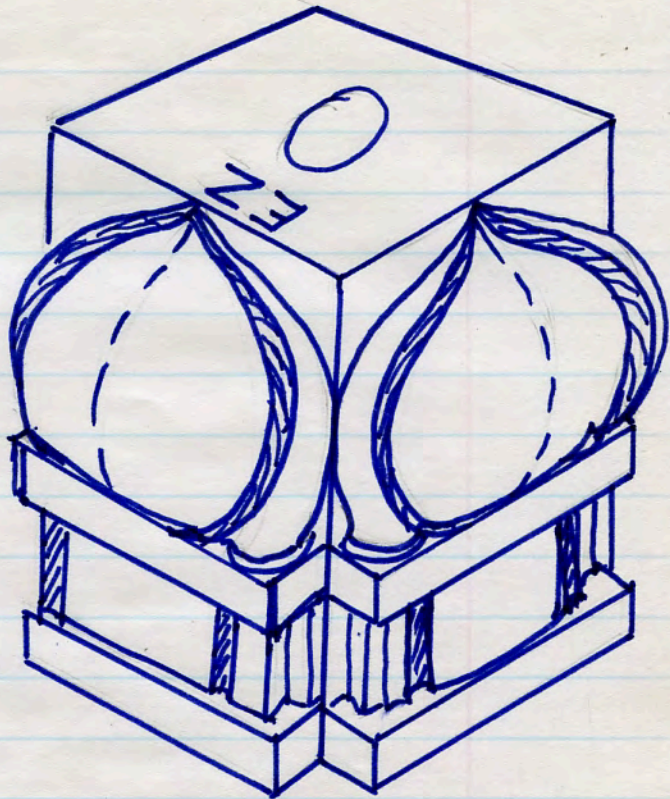

No name. blue paper
13 lbs $9'' \times 9'' \times 2''$

3452

no panels, serrated on base
Mill Lane Spinning Co. Ltd Leigh
dem July 1985.

No name EZ 58 red T.C (Accrington Mori).

$\frac{4}{8}$ lbs. $15" \times 9\frac{1}{2}" \times 4"$
letters protrude $1"$

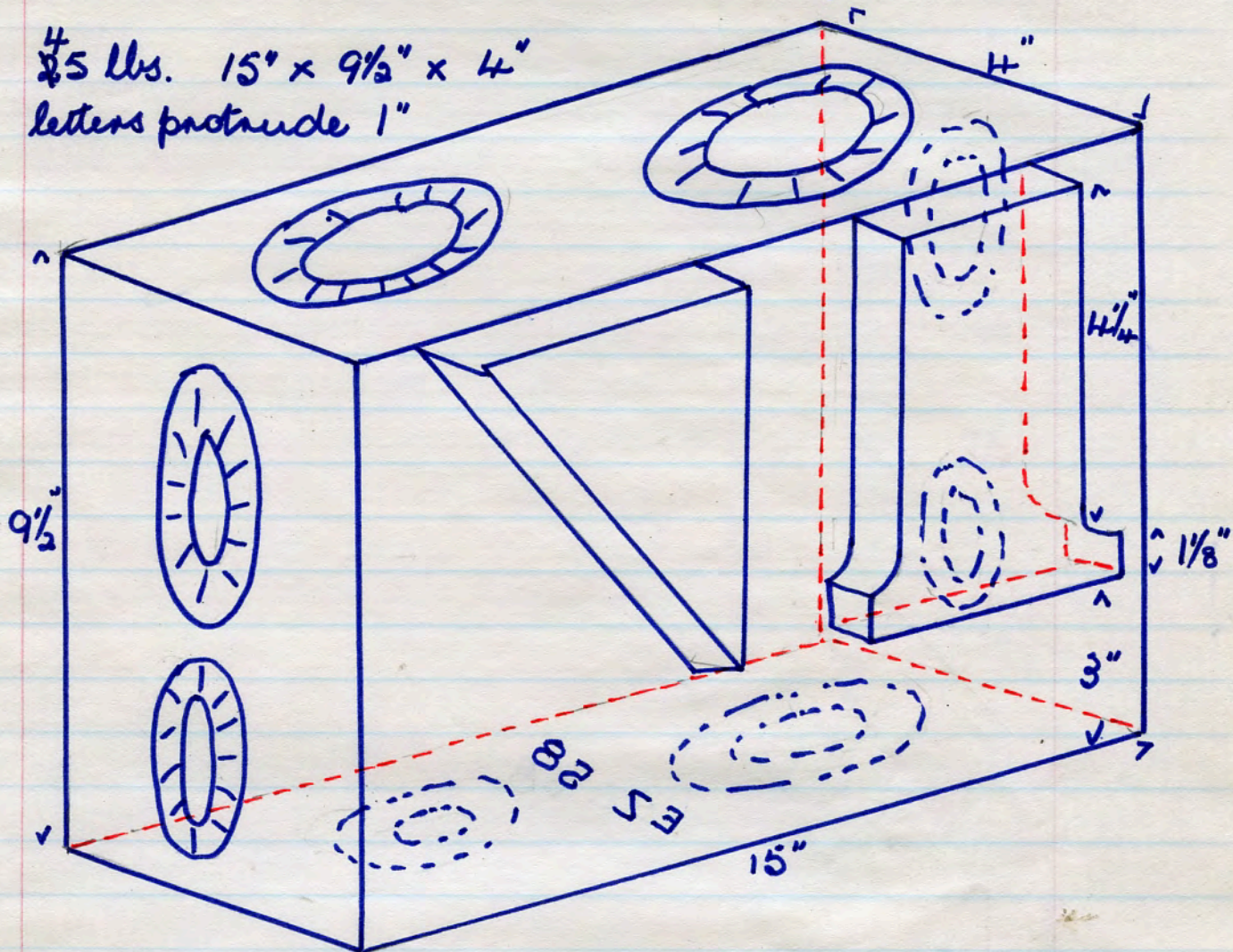

part of the letters N and I in SPINNING
no panels. letters + nos. stamped on base.
Mill Lane Spinning Co Ltd. Leigh.
dem. July 1985.

No name (Accrington Mori) EZ 256 red T.C.
oversailing unit on st/0 of parapet
70 lbs.

no panels. letters & nos. stamped

Mill Lane Spinning Co. Ltd. Leigh. dem. July 1985.

3445.

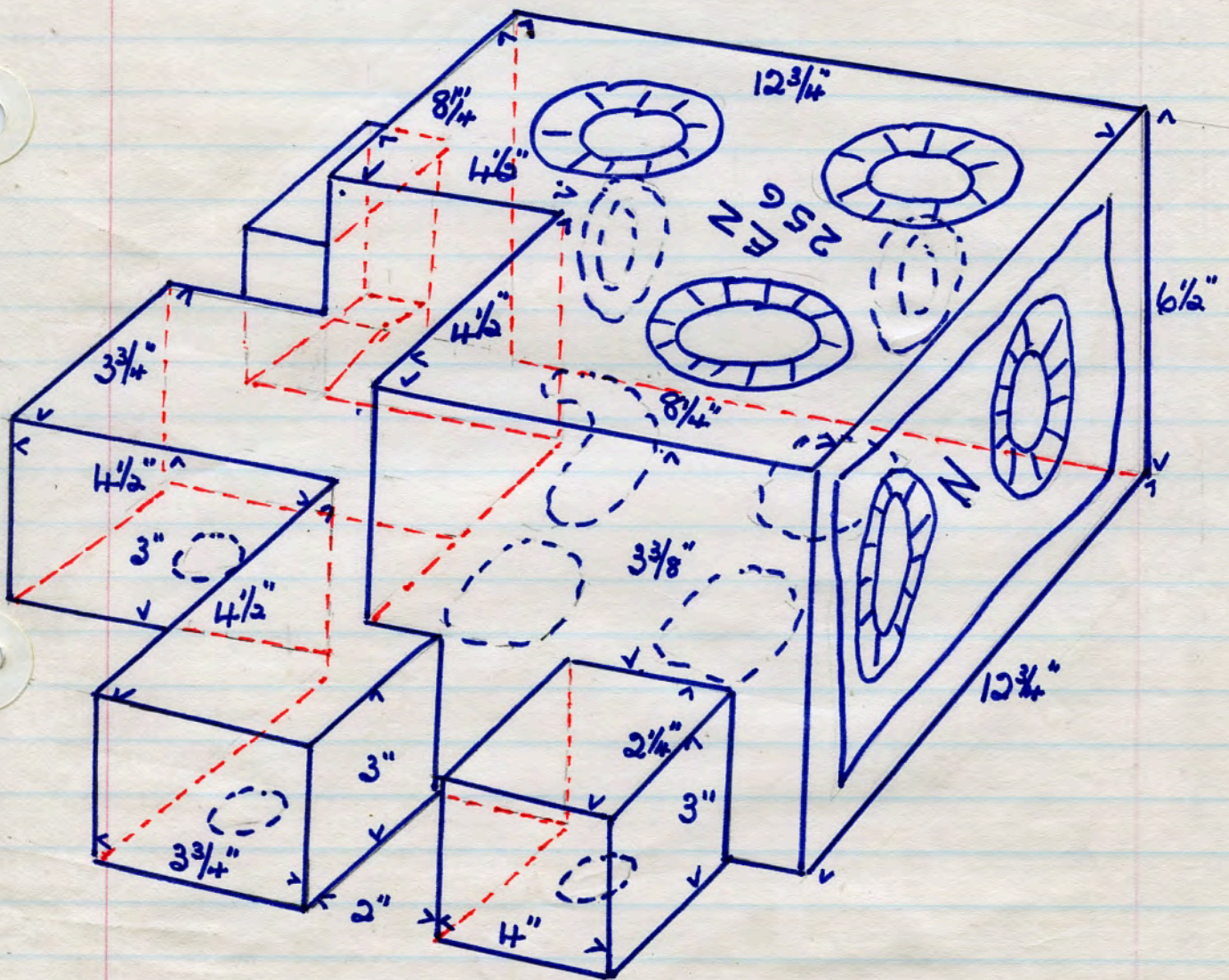

28 lbs. 2 3/4" thick. Leigh.
 No name. Red clay ventilator. Mill Lane Spinning Co Ltd

3446

12"

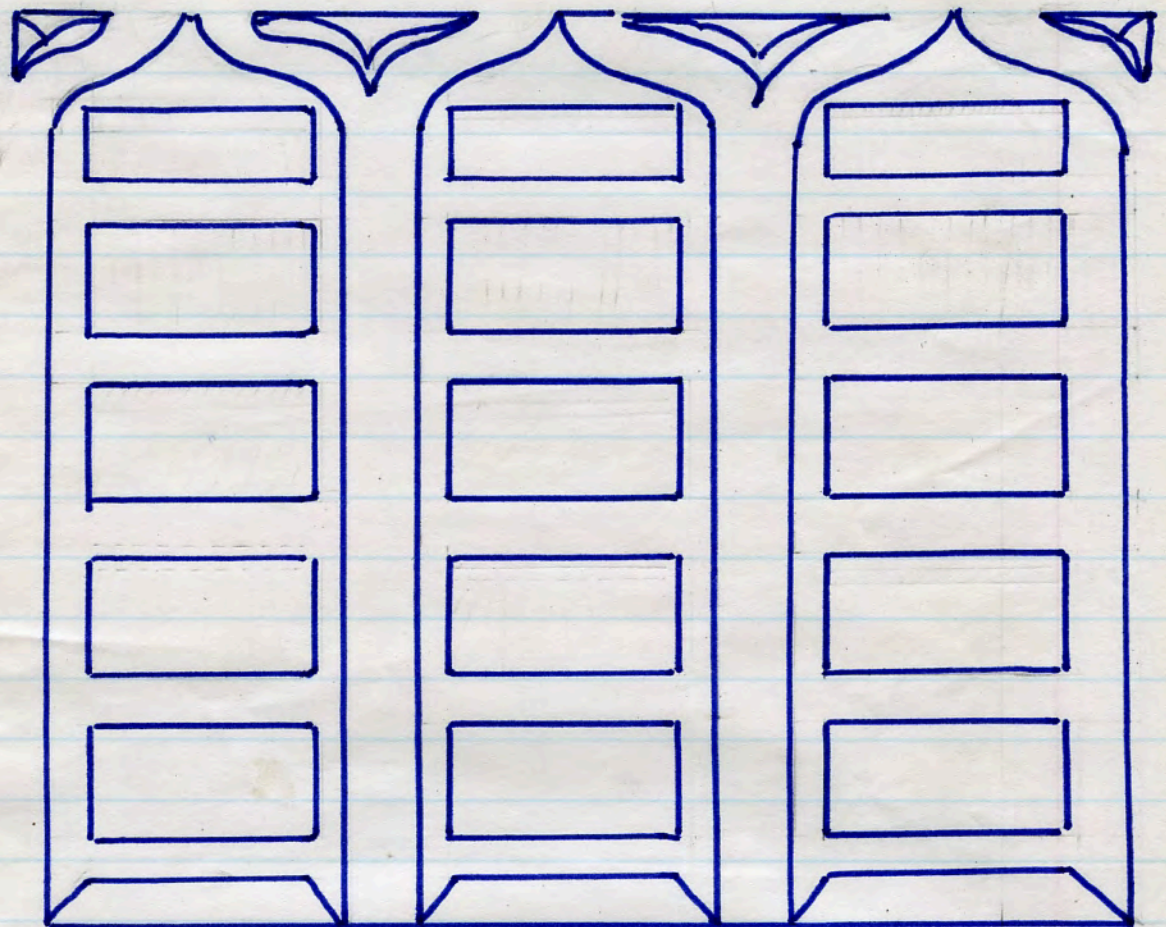

13 3/4"

No name. Part of red T.C rosette from Mill Lane
 this piece 7 lbs
 14" x 14" x 3"
 when whole

Spinning Co Ltd
 Leigh.

dem July 1985

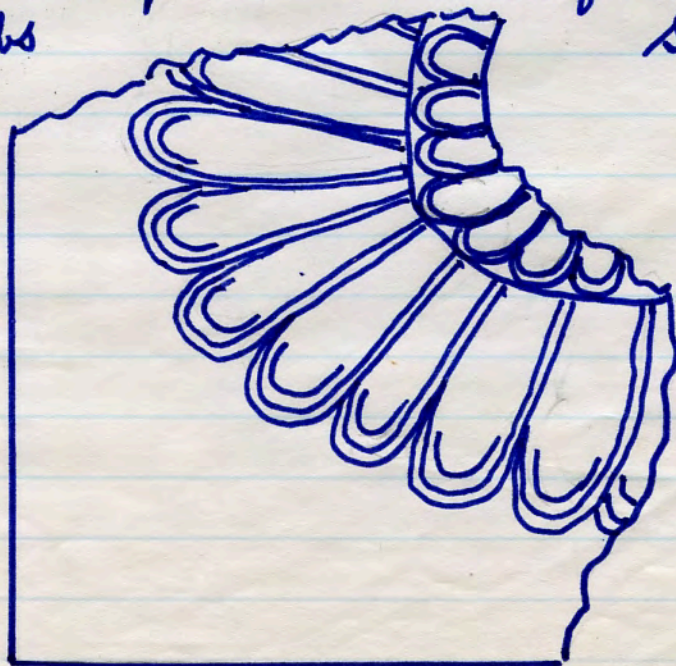

3447

No name. M. red T.C. dec wall cap.
21 lbs. $13\frac{1}{4}'' \times 8\frac{3}{4}'' \times$ broken
water groove \sim $1\frac{1}{4}'' \times \frac{1}{2}''$ each side

3461.

2 perfs, $\frac{5}{8}''$ diam, 1 perf $1''$ diam. letter M incised
Moorfield House, Whalley Rd, Acc/ton. (home of managing
director - Acc. B+J. b.)
6. 7. 85

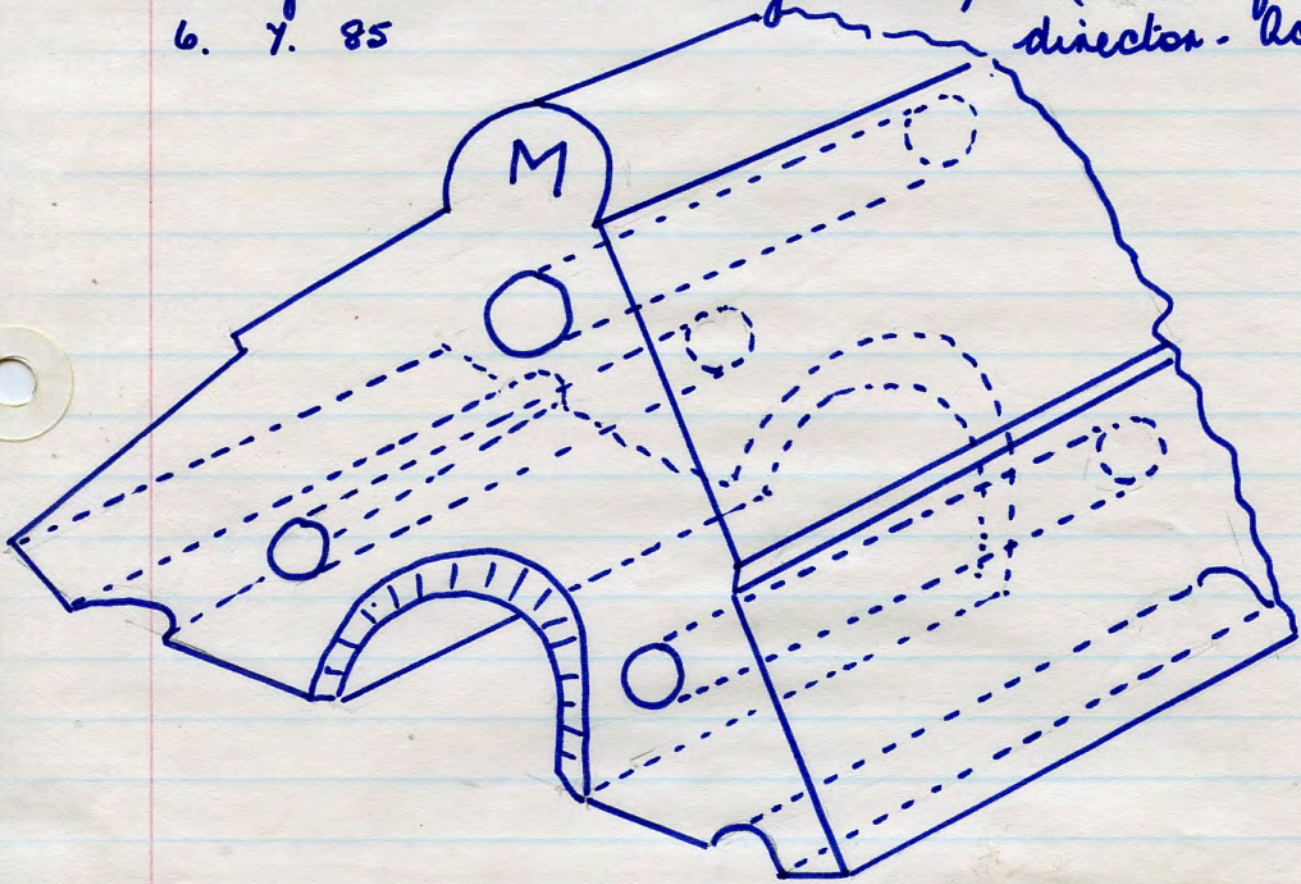

(Accrington B+ J. b. 100.)

No name, blue wall cap.
10 lbs. $11\frac{1}{2}'' \times 6'' \times 3''$
no panels

3486

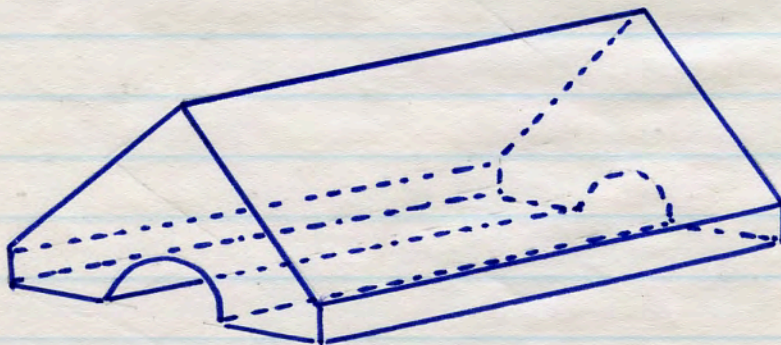

dem. Gladstone Rd, Karmworth. 22. 9. 85

No name. red T.C. piano brk. (Enfield Brk. + J. 6.)
9 lbs. $8\frac{5}{8}" \times 4\frac{3}{8}" \times 2\frac{7}{8}"$ moulded stretchers.
no panels.
Whittakers, Agricultural Machine Dealers (1905) Acc/ton
Bull Bridge. dem. 8. 7. 85.

3462

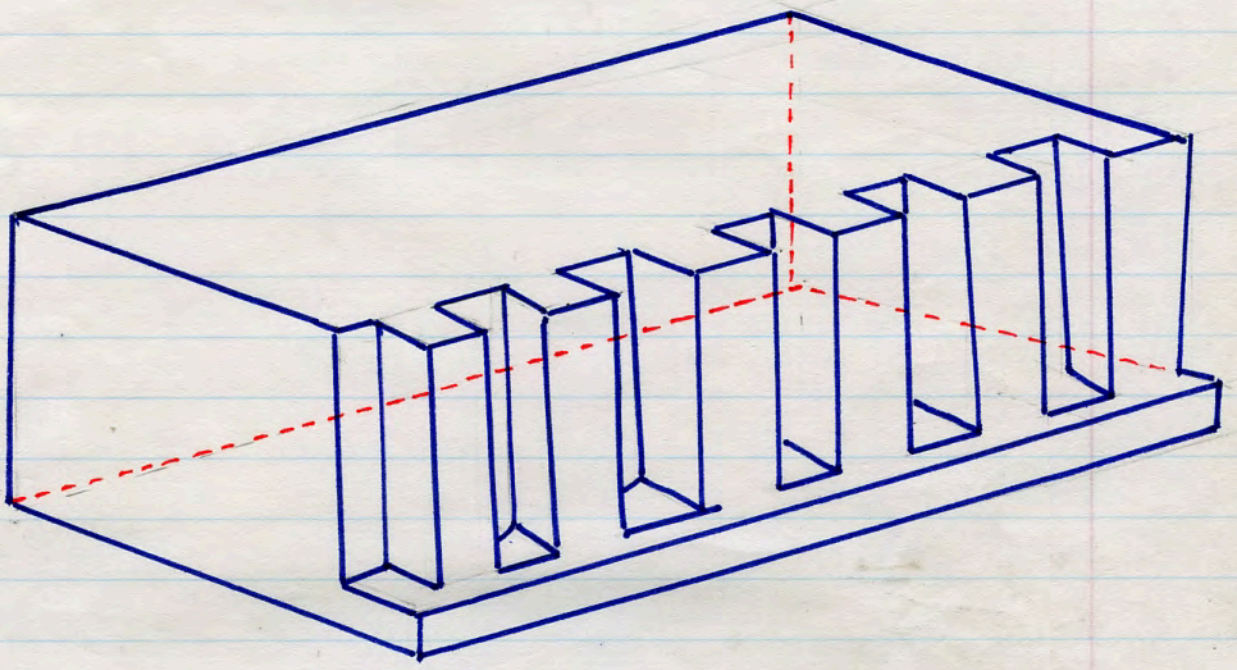

No name. red T.C. moulded stretchers. (Enfield B+T.C.)
11 lbs. $9" \times 3" \times 6\frac{1}{2}"$. no panels
1 perf $1\frac{1}{4}" \times \frac{3}{4}" \times 9"$
Whittakers, Agricultural Machine Dealers (1905). Acc/ton.
dem. 8. 7. 85.

3463

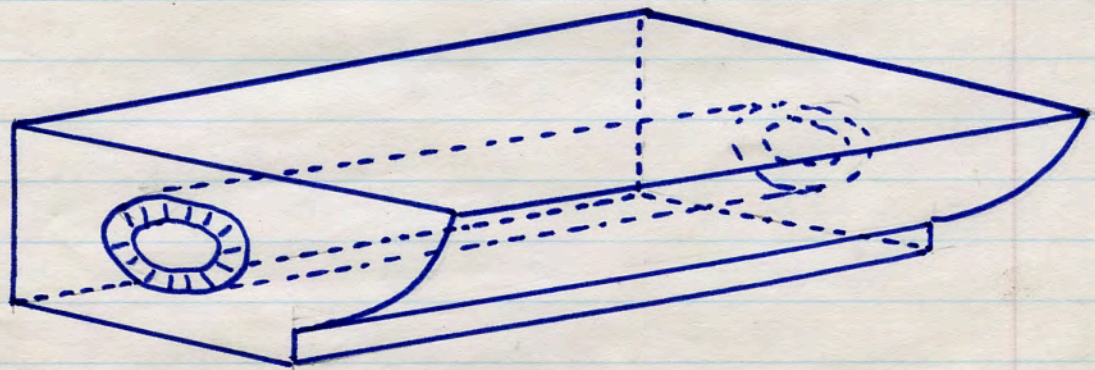

No name (Canfield B + T.C.) red T.C. dec. stretcher.
10 lbs. $9\frac{1}{4}" \times 4\frac{1}{4}" \times 3\frac{1}{4}"$

3464

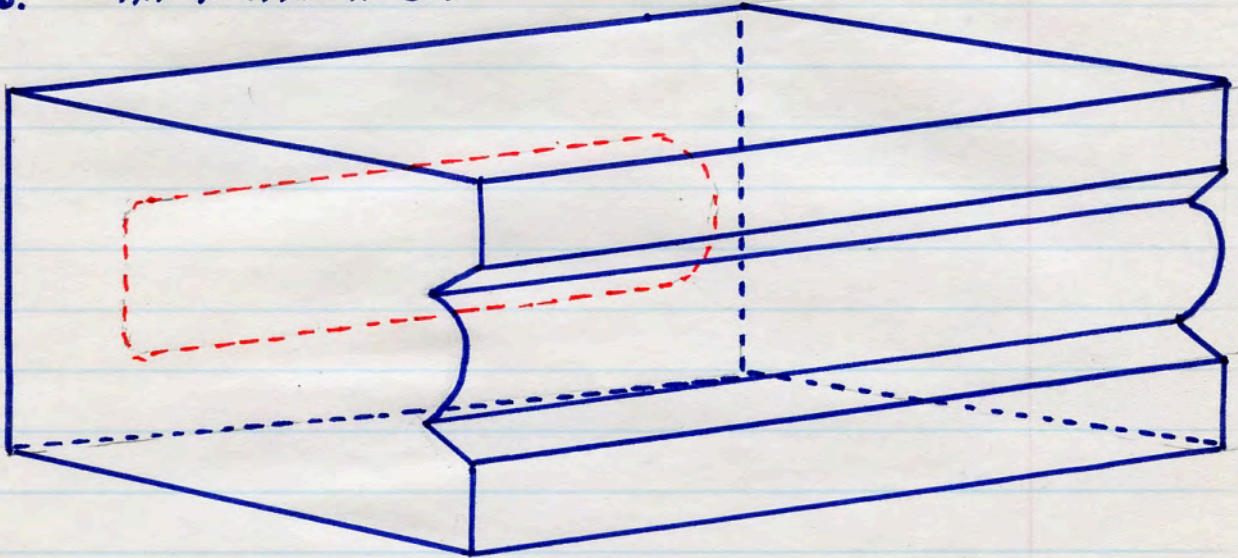

panel in rev. $7\frac{1}{2}" \times 1\frac{3}{4}" \times 1"$ deep. H. Y. '85
St John's Ambulance Hall dem. Bull Bridge Ass/ton.

No name. (Canfield B + T.C.) red T.C. dec. stretcher
10 lbs. $9\frac{1}{8}" \times 4\frac{1}{8}" \times 3\frac{1}{8}"$
panel in rev. as above.

3465

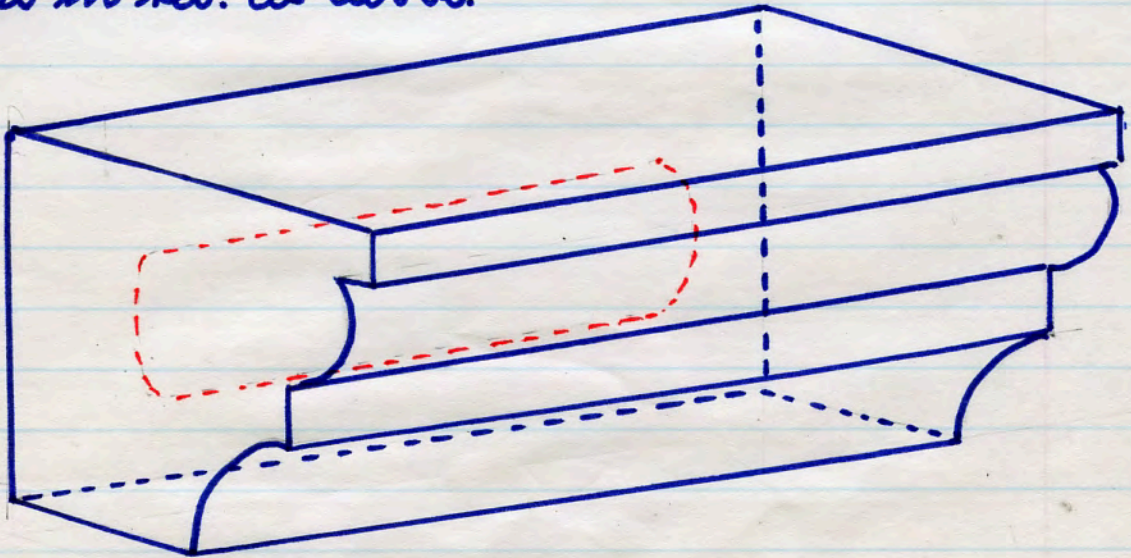

St John's Ambulance Hall dem. Bull Bridge, Ass/ton
H. Y. '85

No name. red T. C. dec. header
9 lbs. 9" x 4³/₈" x 3"

no panels.

J. Haythornthwait's dem
Bull Bridge. Acct/ton 8. 7. '85.

3466

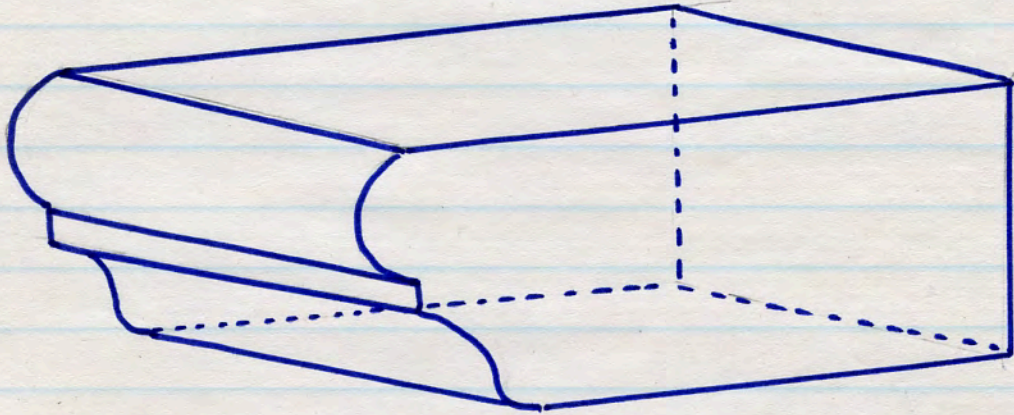

No name. red T. C. dec. header
9¹/₂ lbs. 9" x 4¹/₂" x 3"

panel in top.

J. Haythornthwait's dem. Bull Bridge, Acct/ton
8. 7. '85

3464

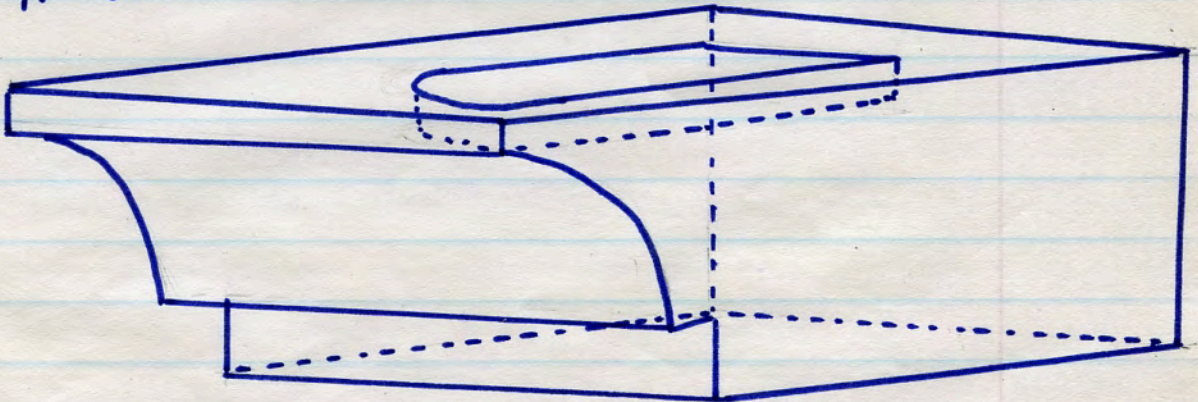

No name. red T.C. dec. quaged brk
 11 lbs. 9" x 5 1/2" reducing to 4 1/2" x 3" - 2 3/4"
 cavity in rev. 6" x 1 1/2" x 5/8"
 scratched panel on each side 1/8" deep.

J. Haythornthwaite, dem. Bull Bridge, Acc/ton 8. 7. '85

3468

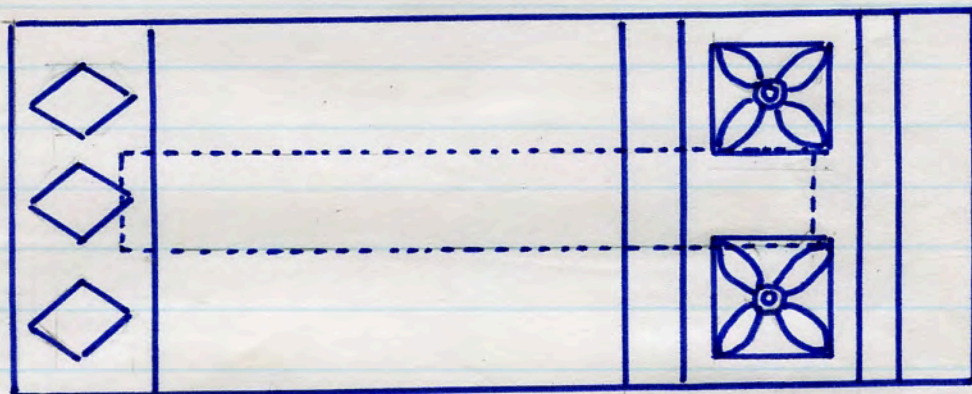
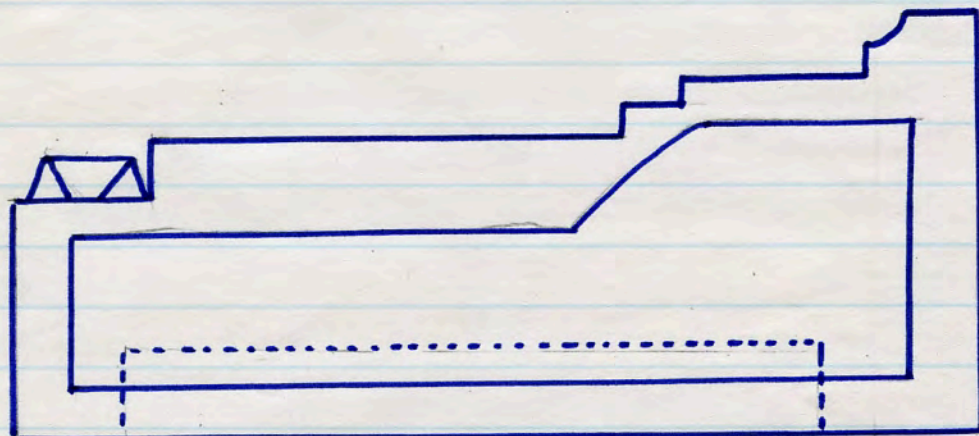

6 1/8" Enfield B + J bo. cat. no. 142.

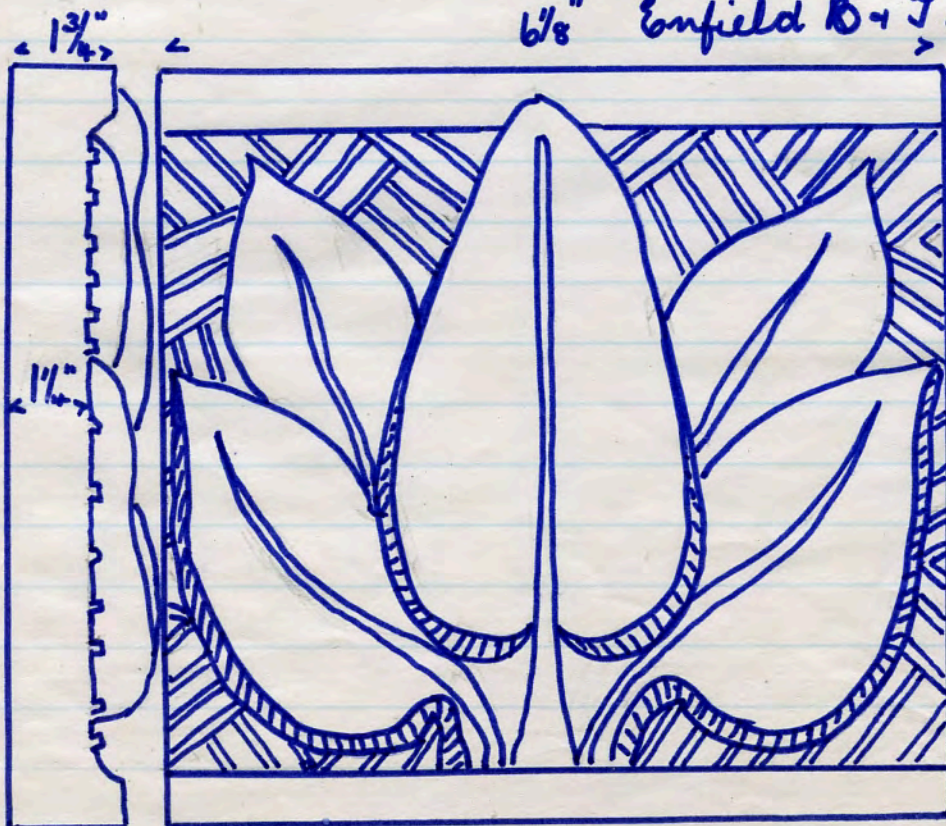

No name
 no panels.
 dec. red T.C
 plaque
 from

6 1/4"

Bull Bridge dem
 Acc/ton -
 as above.
 7 lbs.

3496

No name. Spitter 20 lbs.

3479

3" x 2"

4" x 4"

3 1/2"

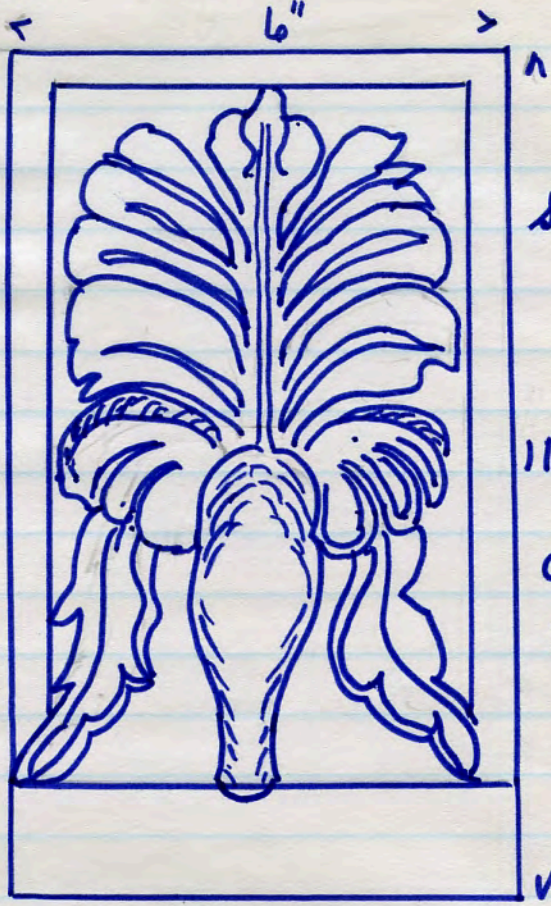
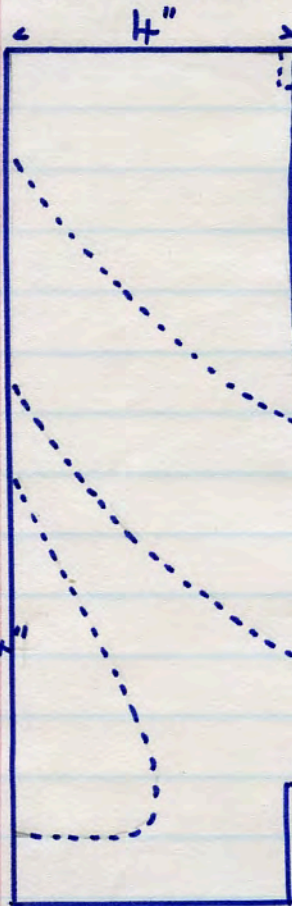

Salt glazed all round.

11 3/4"

Gower St dem.
Karnworth

22. 9. 85.

No name. (Canfield) red T.C boss

3480

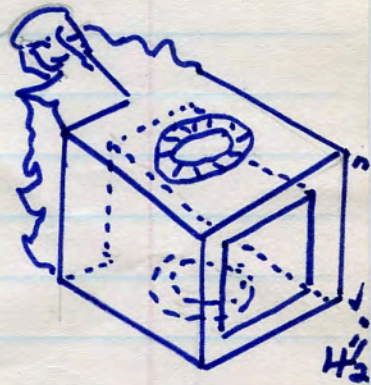

18 lbs

6 3/8" x 6 3/8"

Boundary wall of
Canfield B + T. L. Co. dem.

Jubilee St entrance

27. 7. 85.

No name. SO22 (Enfield B + T. L. Co.) stone coloured
 15 lbs. T.C.

3487

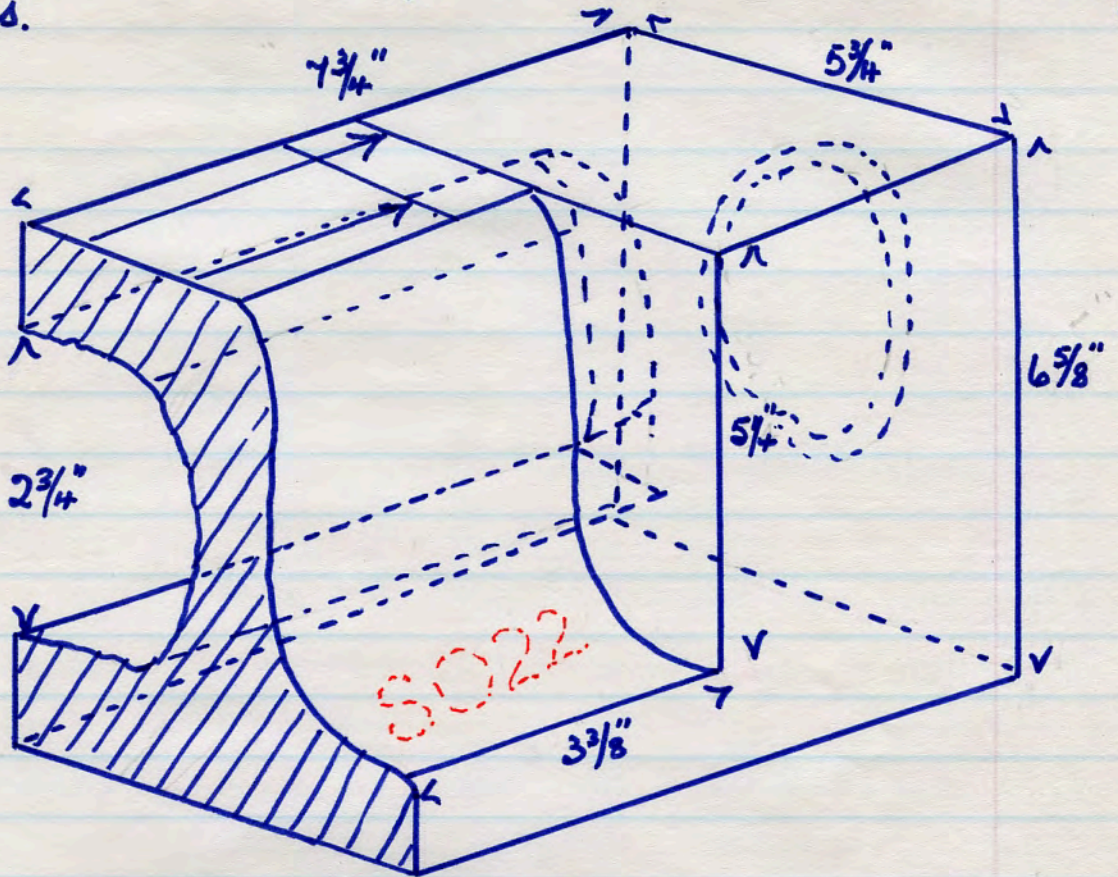

28 lbs.

3488

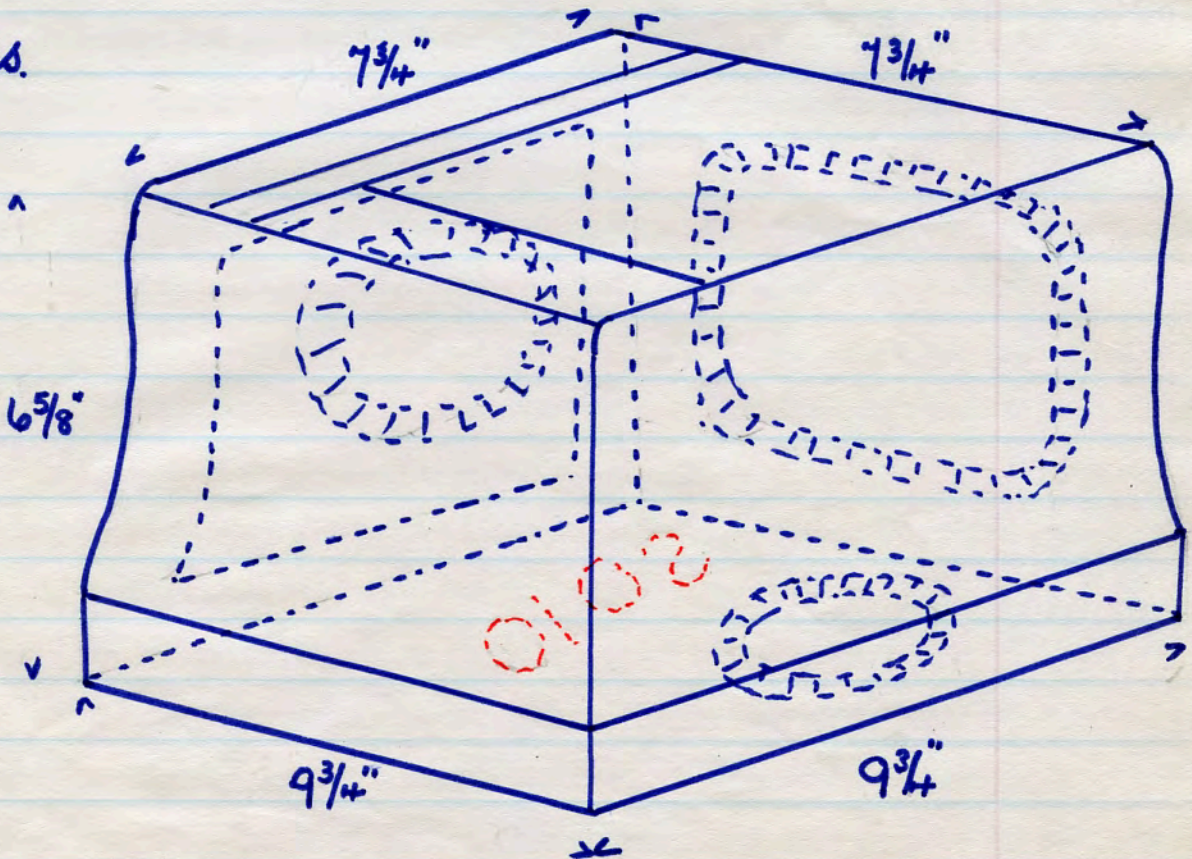

These 2 pieces formed a string course at the base of the exterior of the chimney breast, and reduced the brickwork above

Office of Stanhill Ringmill, O/twistle ut acc/ton 28. 9. 85.

No name SO 130 (Enfield B + T.C.) stone coloured T.C.
 14 lbs Key piece to flat arch of offices

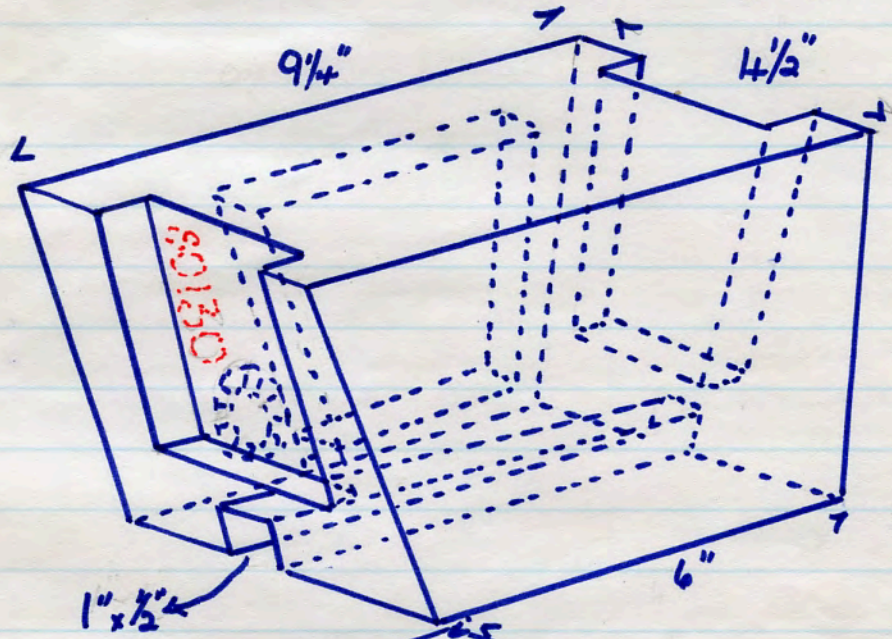

3489

Section of mould

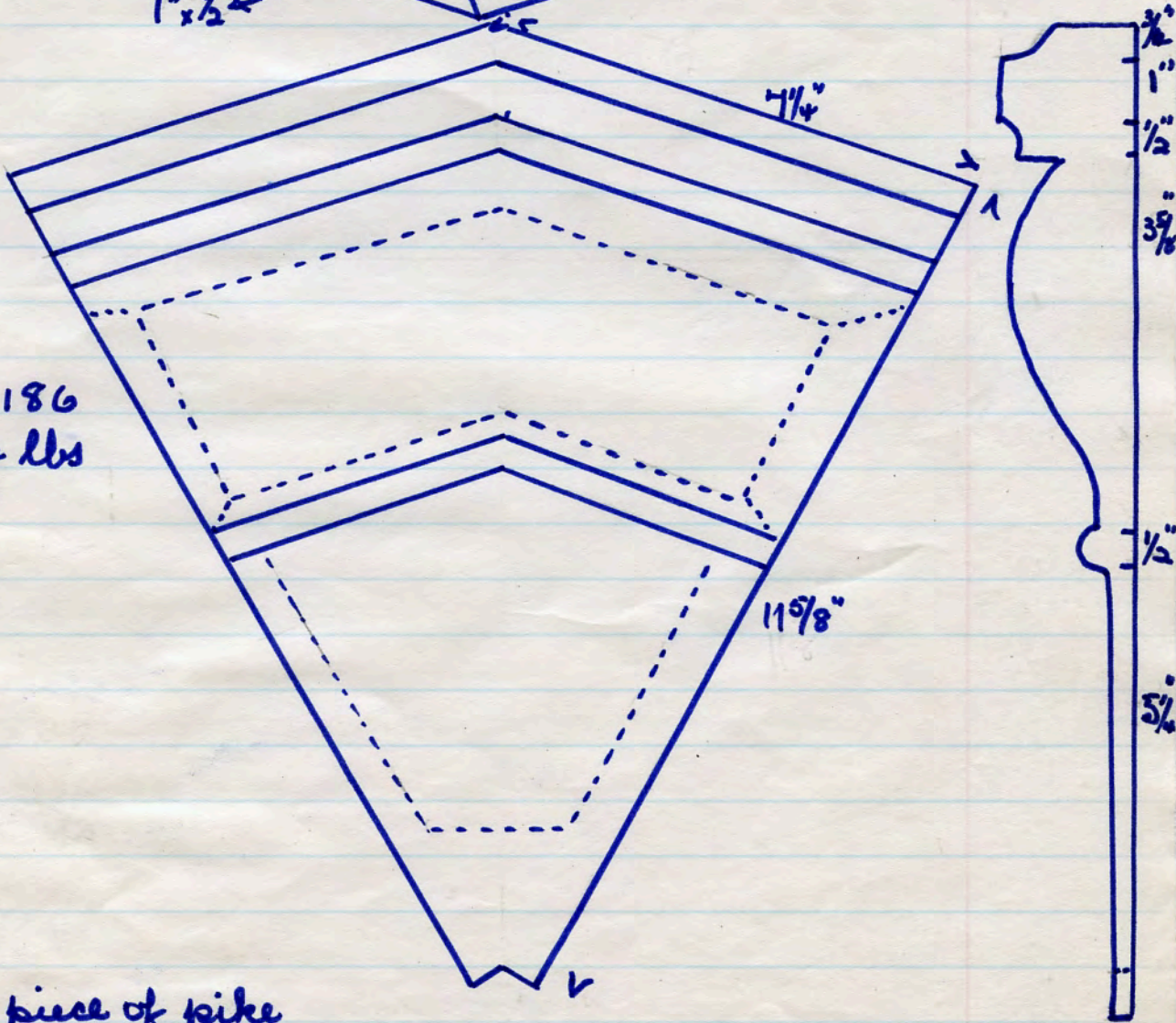

3490

SO 186
 24 lbs

Key piece of pike

Stanhill King Mill, 10/12 twist, Office dem. 23. 6. 85.

No name SO 12 (Enfield B + T.C). stone coloured T.C
31 lbs.

sill return end
for continuity
of mould. \angle

3491

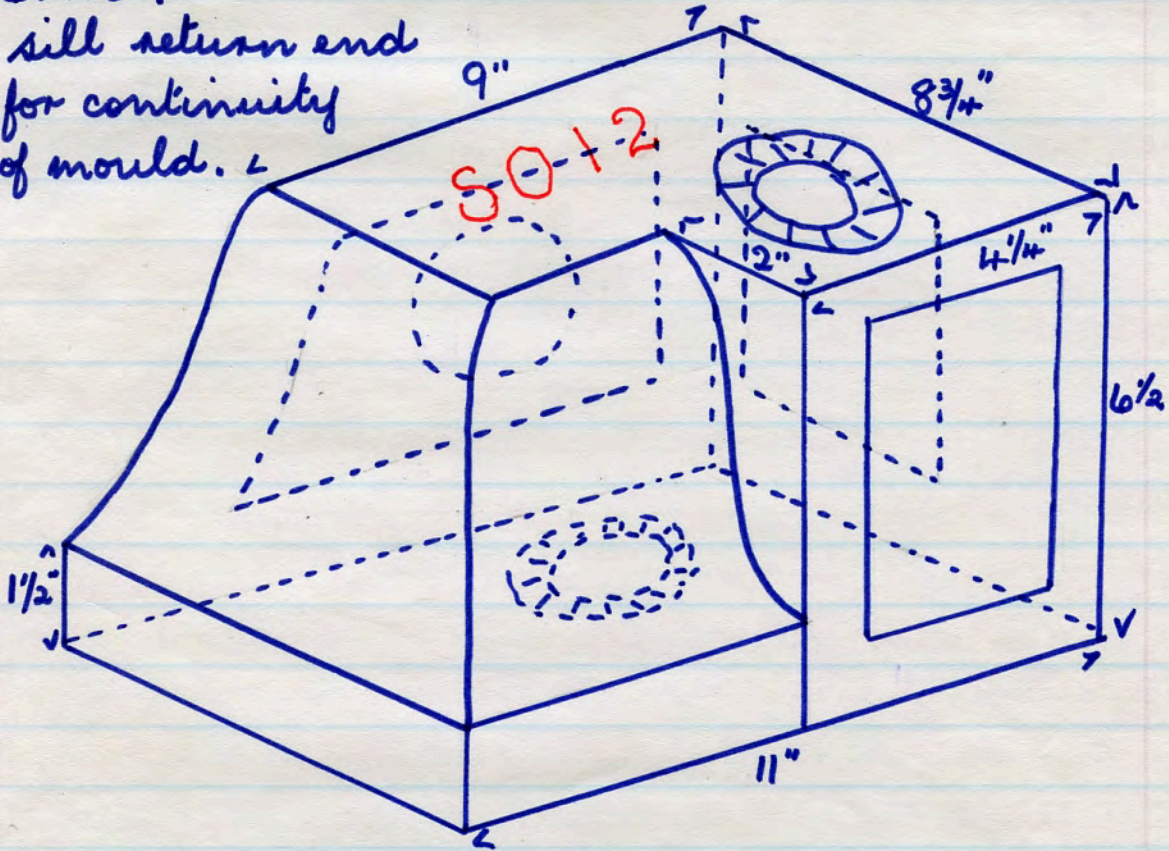

SO 19 sill return
28 lbs

3492

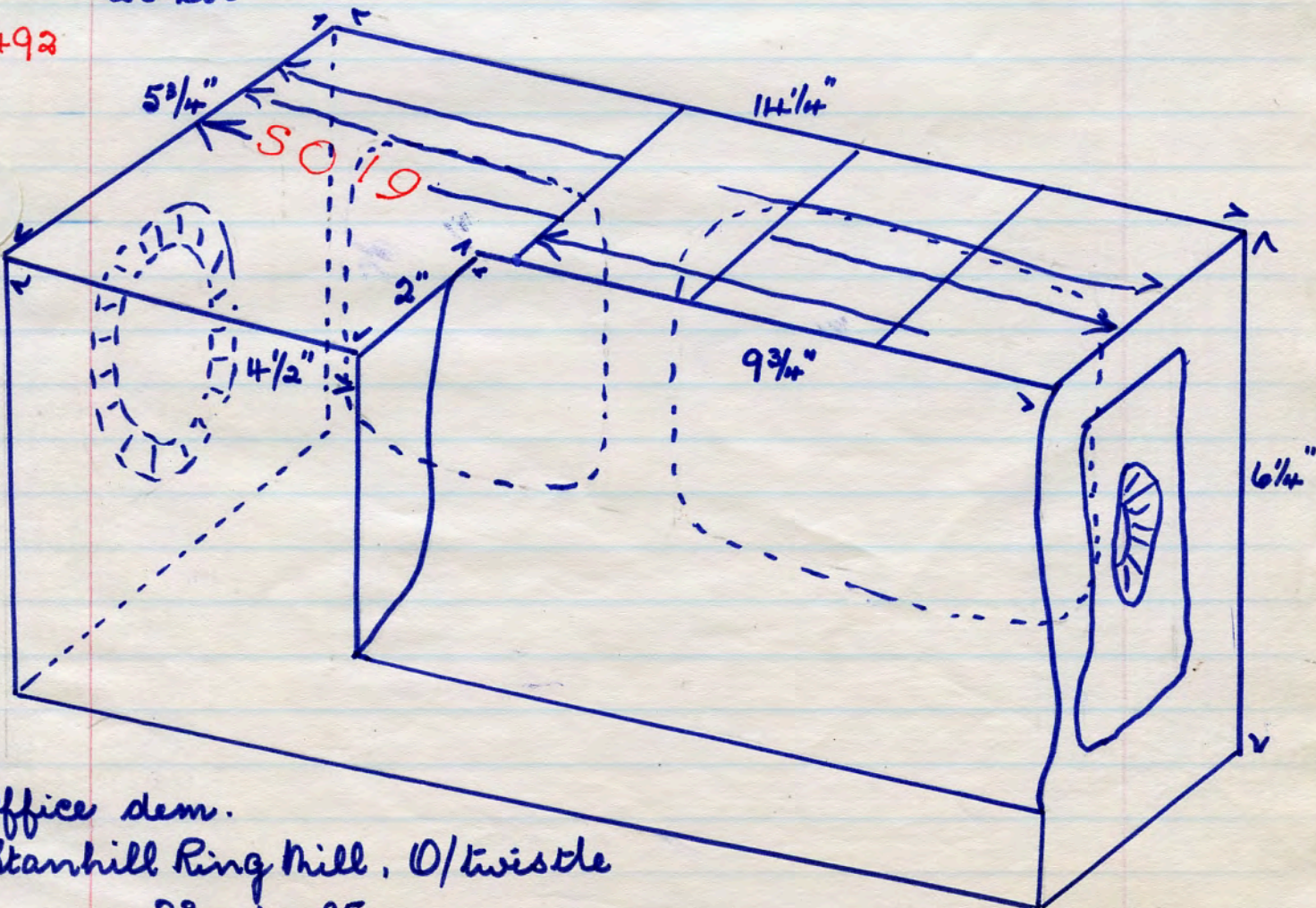

Office dem.
Starhill Ring Mill, O/twistle
23. 6. 85.

No name. (Enfield B.T.C.) SO 62 architrave to
28 lbs stone coloured T.C. windows.

for details of mould
see 3490.

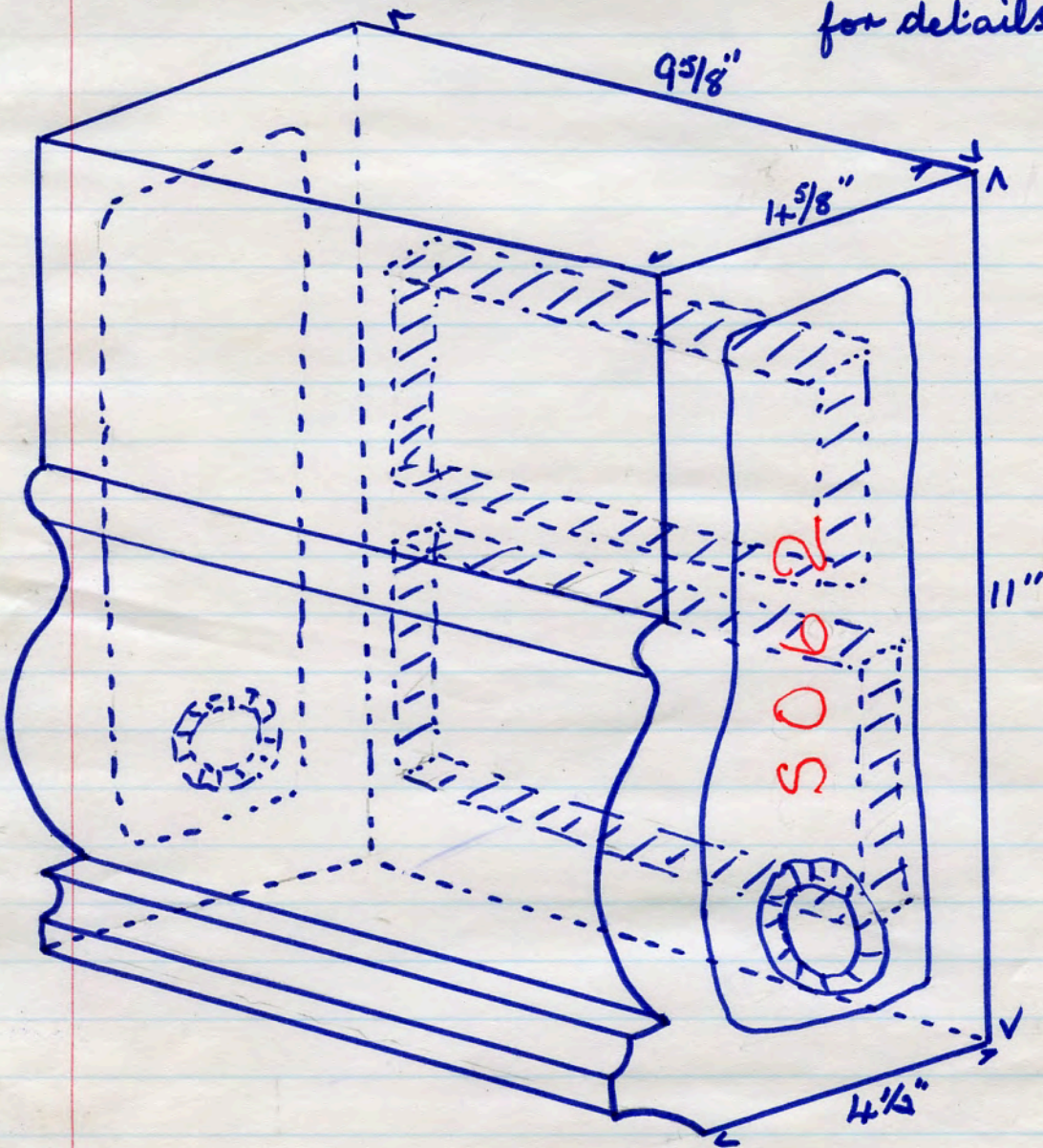

3493

Office dem. Stanhill Ringhill. O/twistle. 23. 6. 85

No name SO4⁶ (Infield B-T.C) stone coloured T.C.
52 lbs. string course return
Office dem. Stanhill Ring Mill. 0/twistle. 23. 6. 85

3494

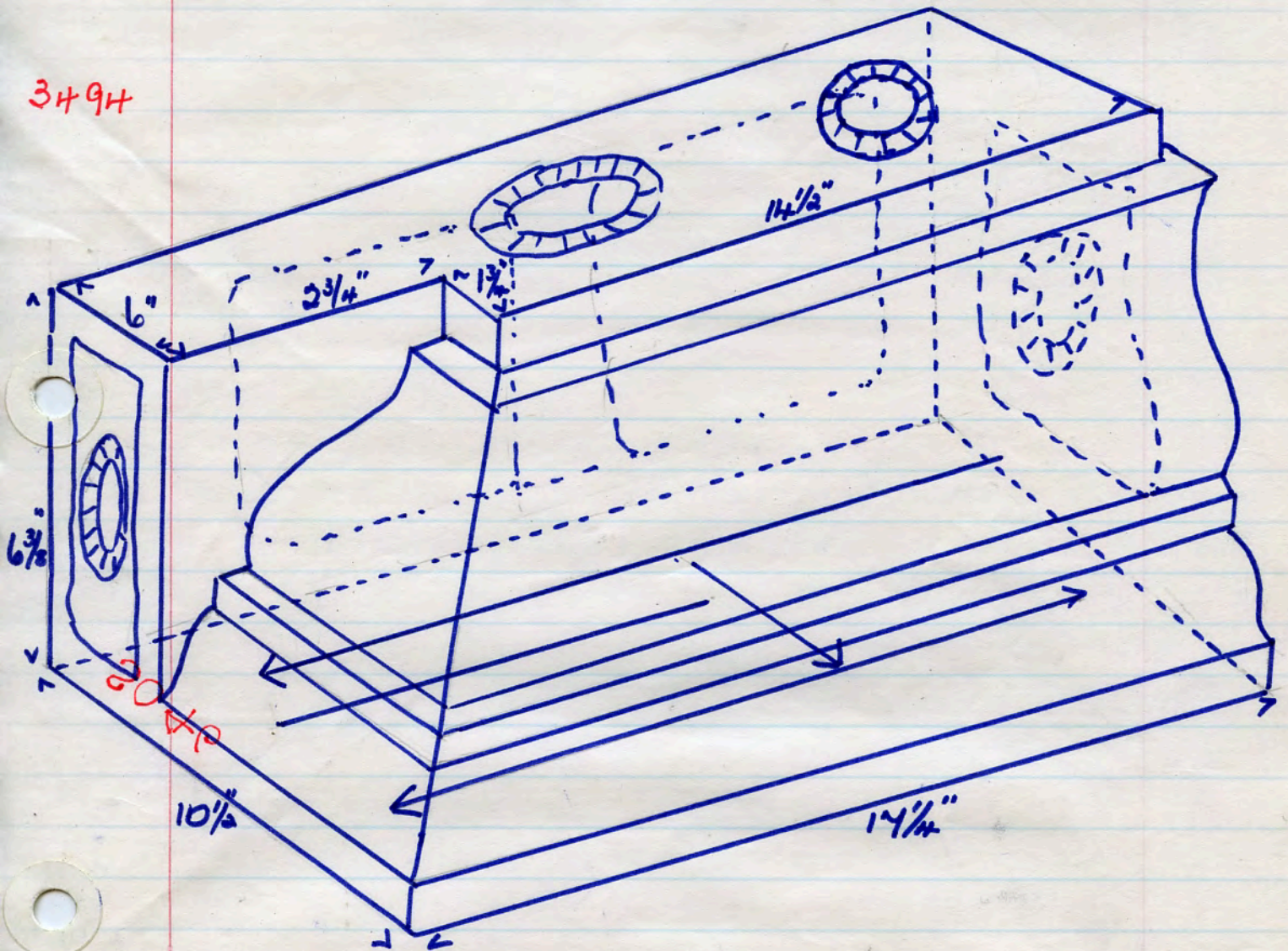

No name. SO 143 (Enfield B+T.C.) stone coloured T.C. abacus.

3495.

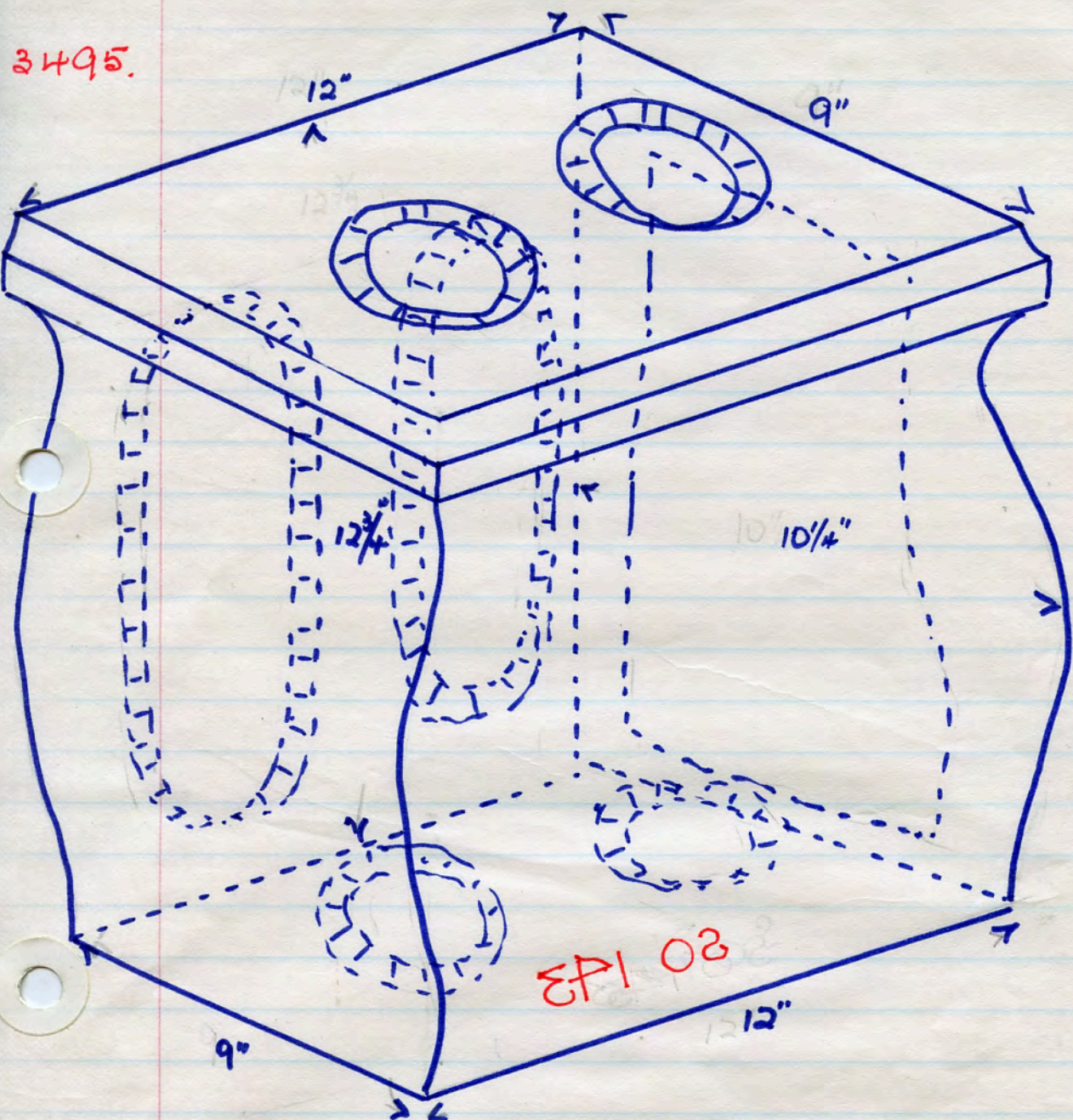

SO 143

Office dem. Stanhill Ring Mill. O/Twistle 23. 6. 85

3497

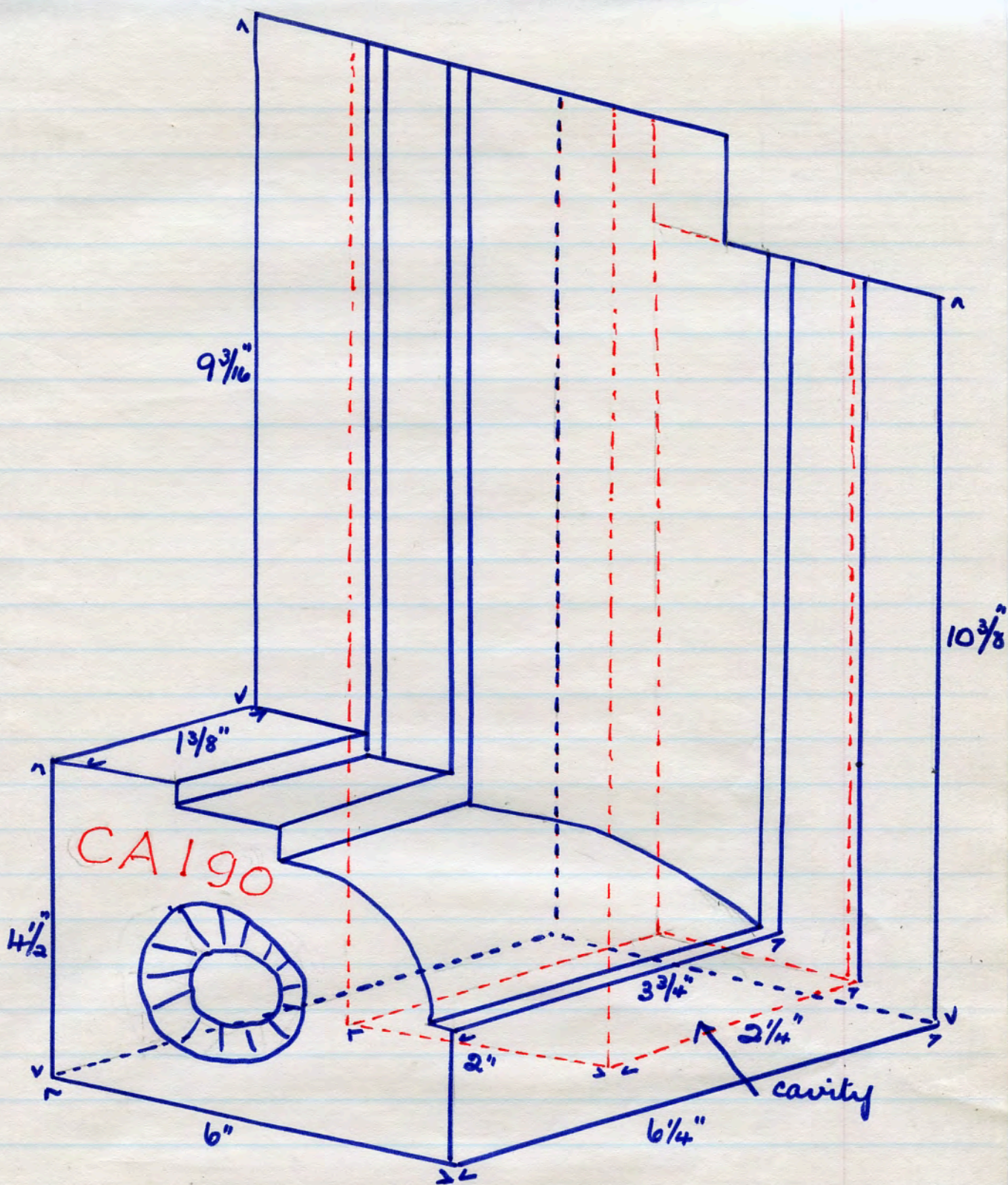

No name CA 190 (Accrington Hosi) 1931.
red T.C. dec window or door casing 23 lbs.
St John's Ambulance Hall dem. Bull Bridge, Acc/ton
H. 7. 85.

No name CA44 (Accrington Maxi) red T.C
 fork junction for window to left & window to right
 with step joints
 Air cavity for burning
 on angle.

3498

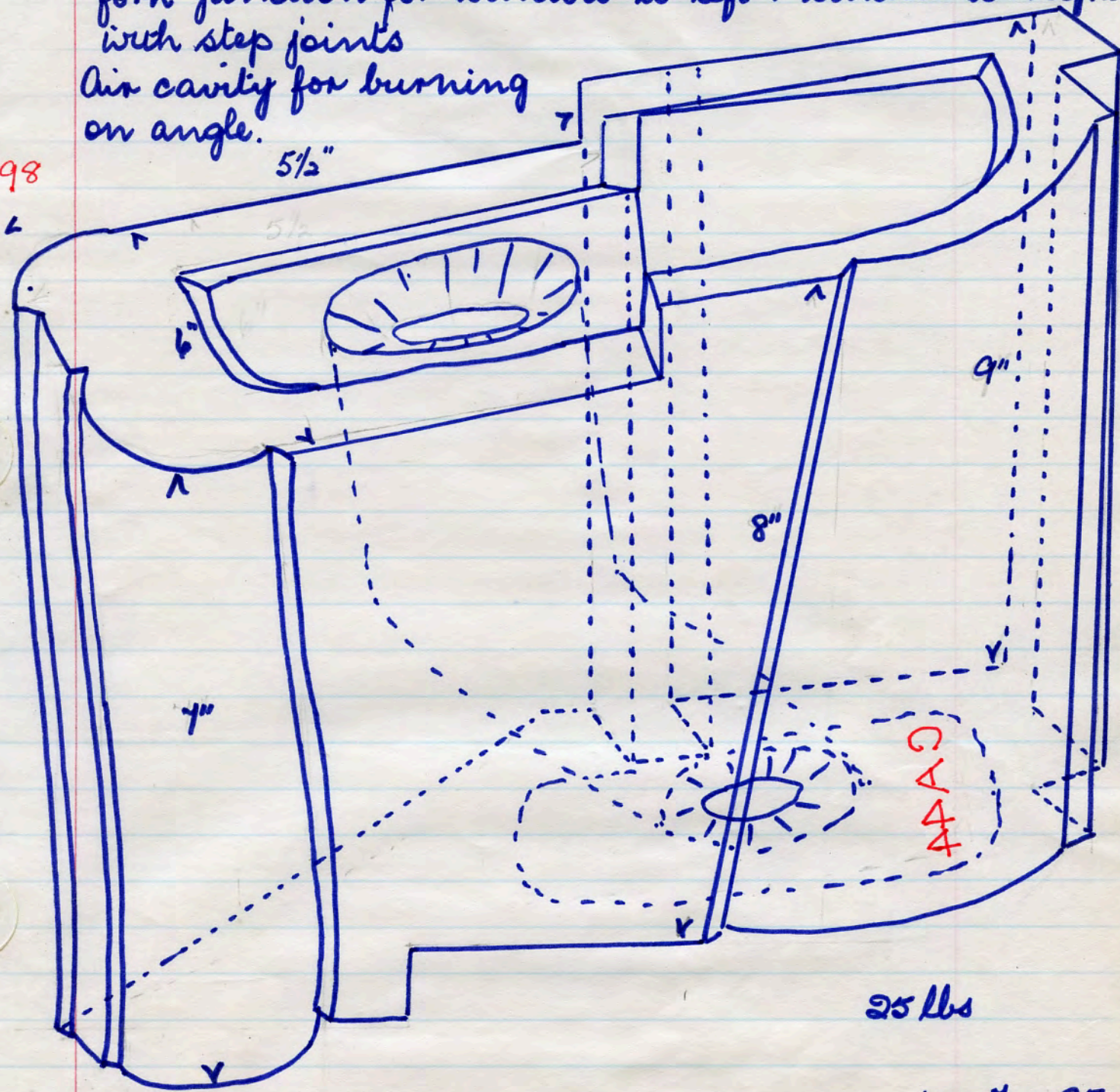

St John's Ambulance Hall dem. Bull Bridge, Acc/ton

No name. red T.C panel
72 lbs.

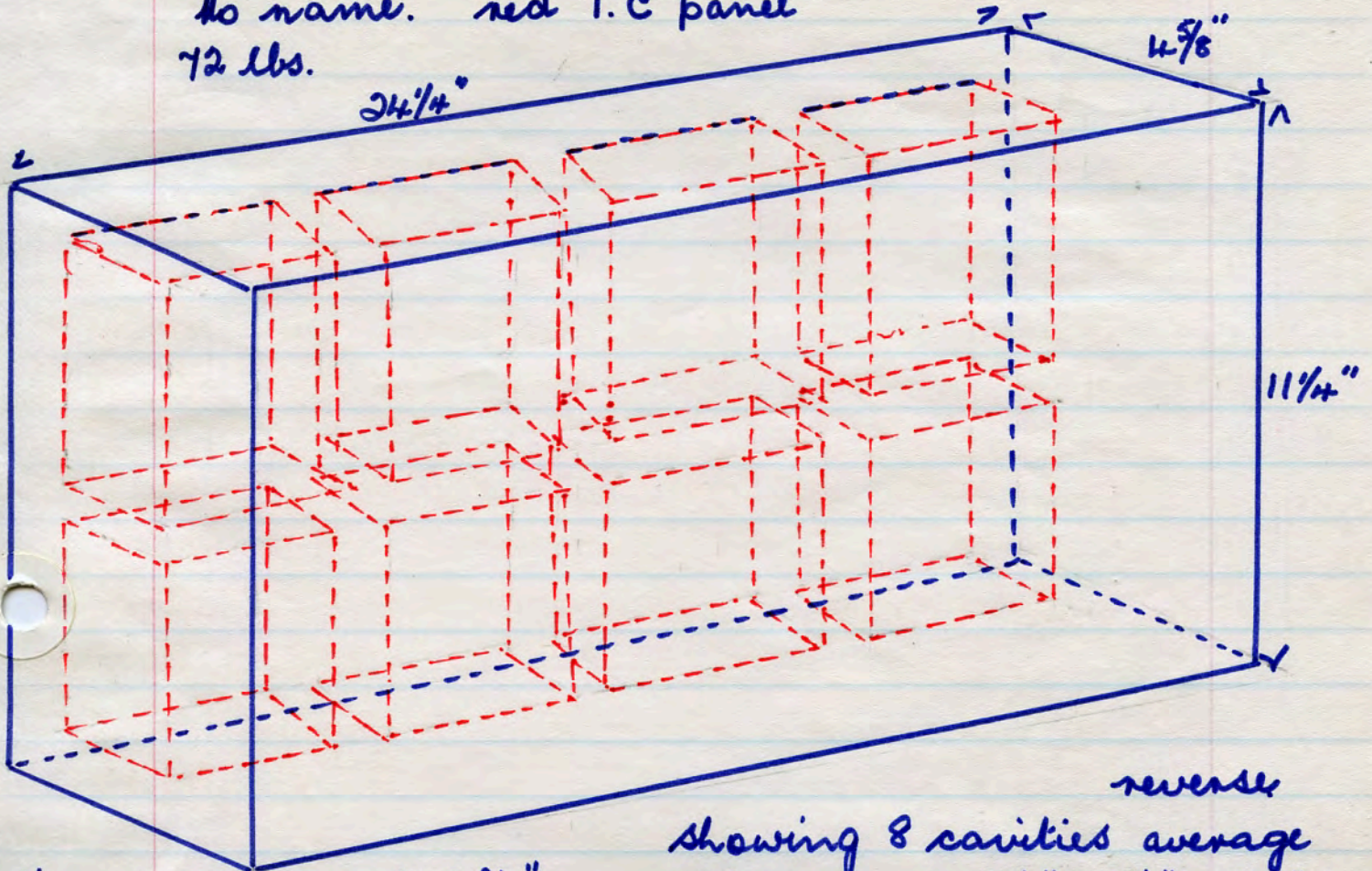

Flower, H, in relief $\frac{3}{4}$ "

reverse
showing 8 cavities average
dimensions $3\frac{1}{2}$ " x $3\frac{1}{8}$ " x $2\frac{1}{2}$ "

3502

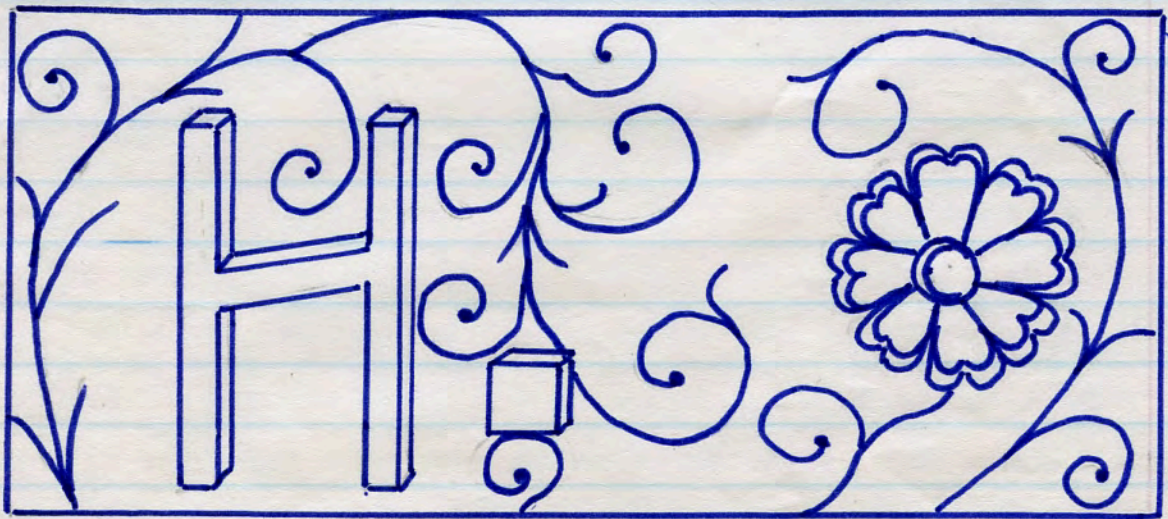

J. Haythornthwait's dem. Bull Bridge, Acc/ton.
(1898 date of man/mc) 9. 8. 95.
red T. C

3503

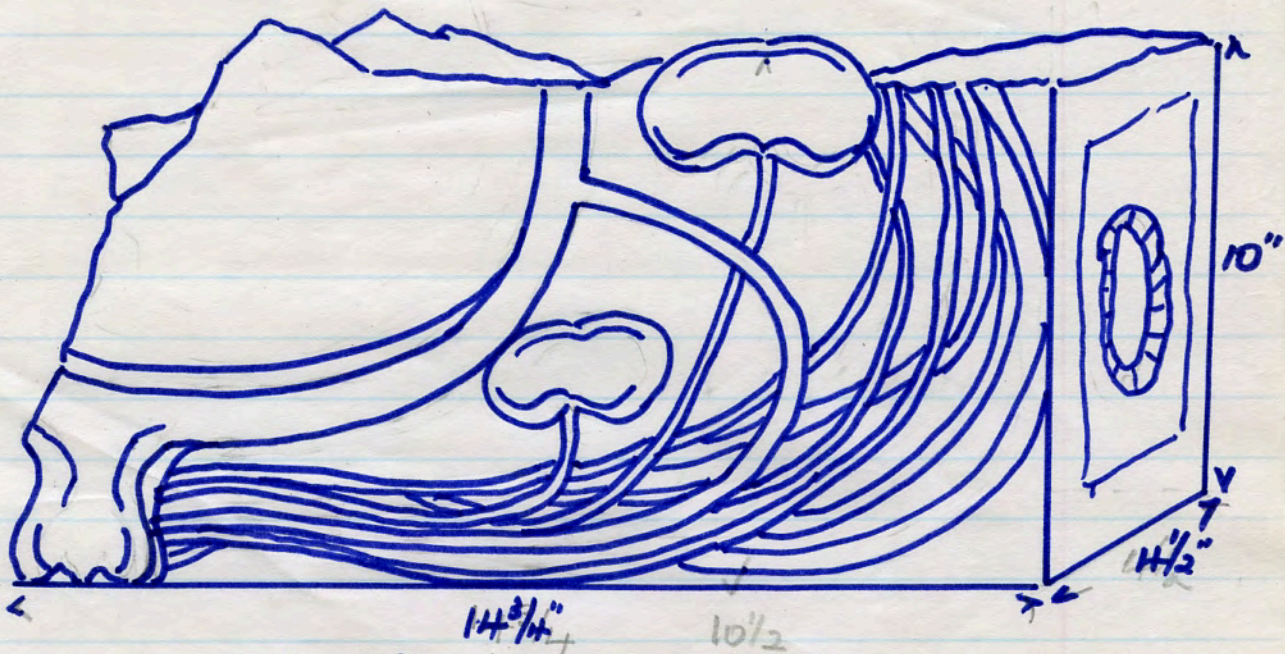

no name. (CA) (Assington Mass) red T.C.
broken piece from base of shield
St John's Ambulance Hall dem. Bull Bridge, Gcc.
44 lbs. 9. 8. 85

No name. EZ 32
 red T.C
 dec. pillar in
 shape of lotus
 flower

3504

50 lbs
 2 box cavities
 in seat.

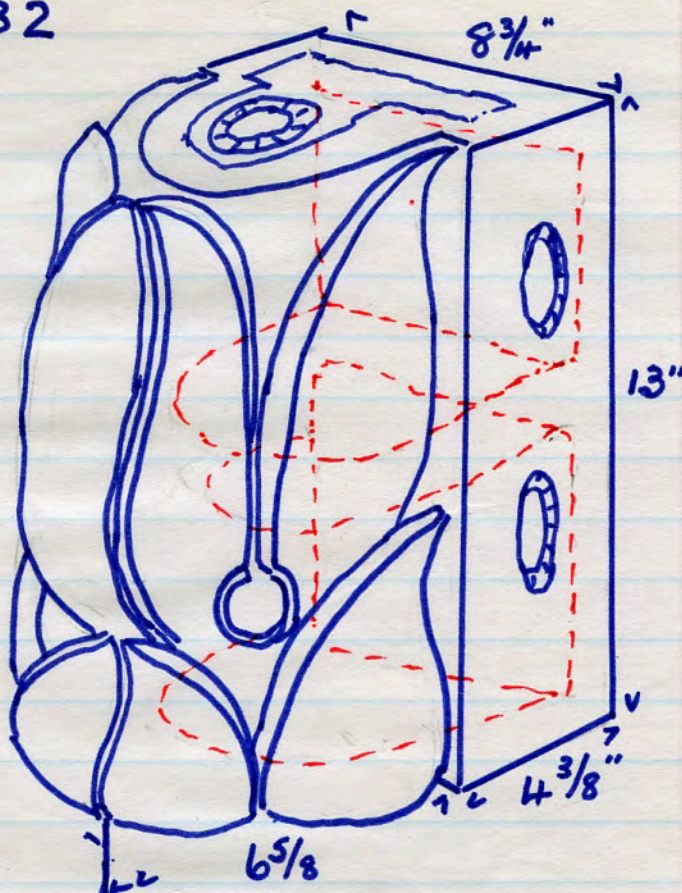

Mill Lane
 spinning co Ltd
 Leigh
 28. 7. 85

No name. EZ 235 red T.C. part of dec. pillar.
 84 lbs 4 box cavities in rear.

3516

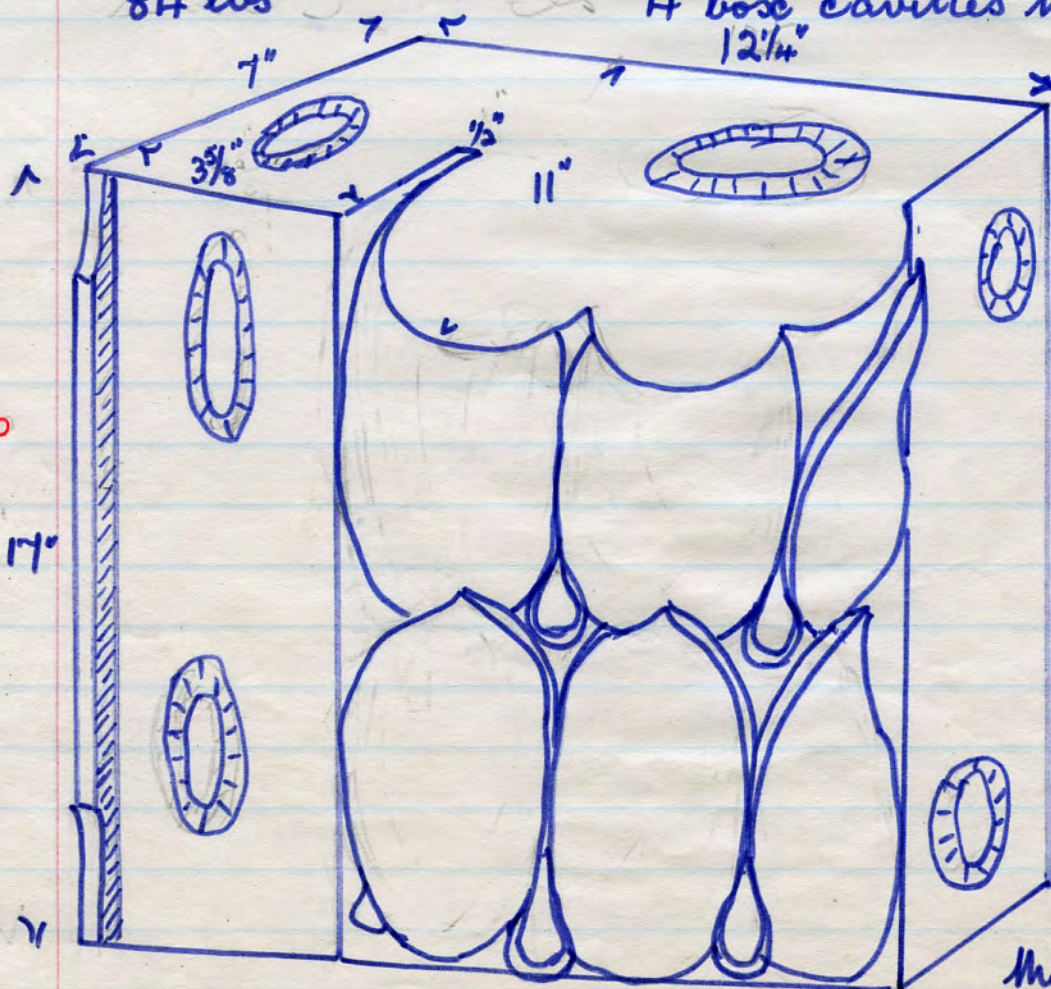

rear view

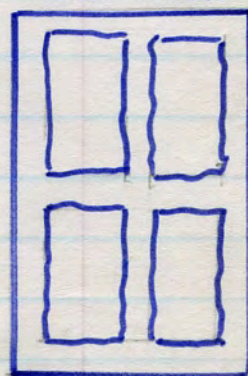

11" back to front.

28. 7. 85.
 Mill Lane, Leigh.

No name. CA 149 red T.C. return end of weather bar
98 lbs

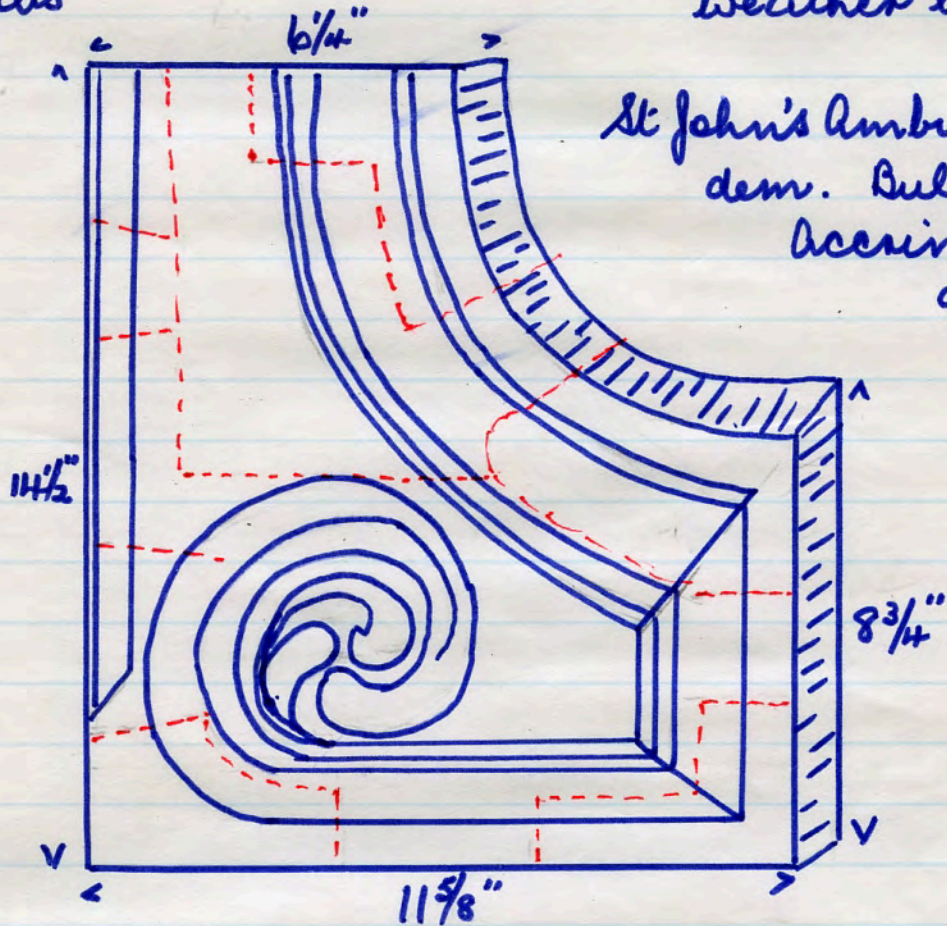

St John's Ambulance Hall
dem. Bull Bridge
Accrington.
9. 8. 85.

3505.

No name (Accrington) EZ 157 also letter B in base
129 lbs

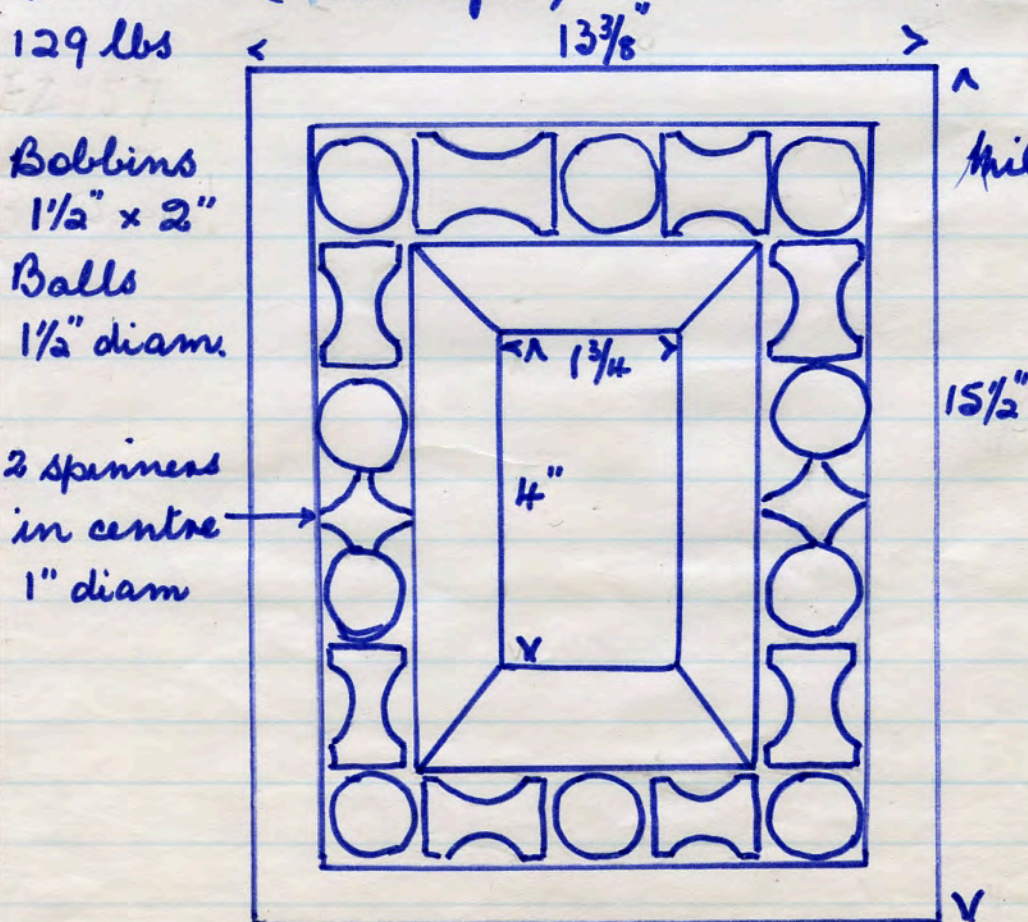

Boblins
1 1/2" x 2"

Balls
1 1/2" diam.

2 spinners
in centre
1" diam

Mill Lane, Leigh
7. 7. '85

3518

Rear view

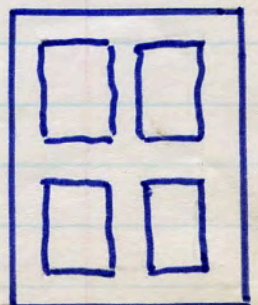

No name. 30 163 stone coloured T. C

3506

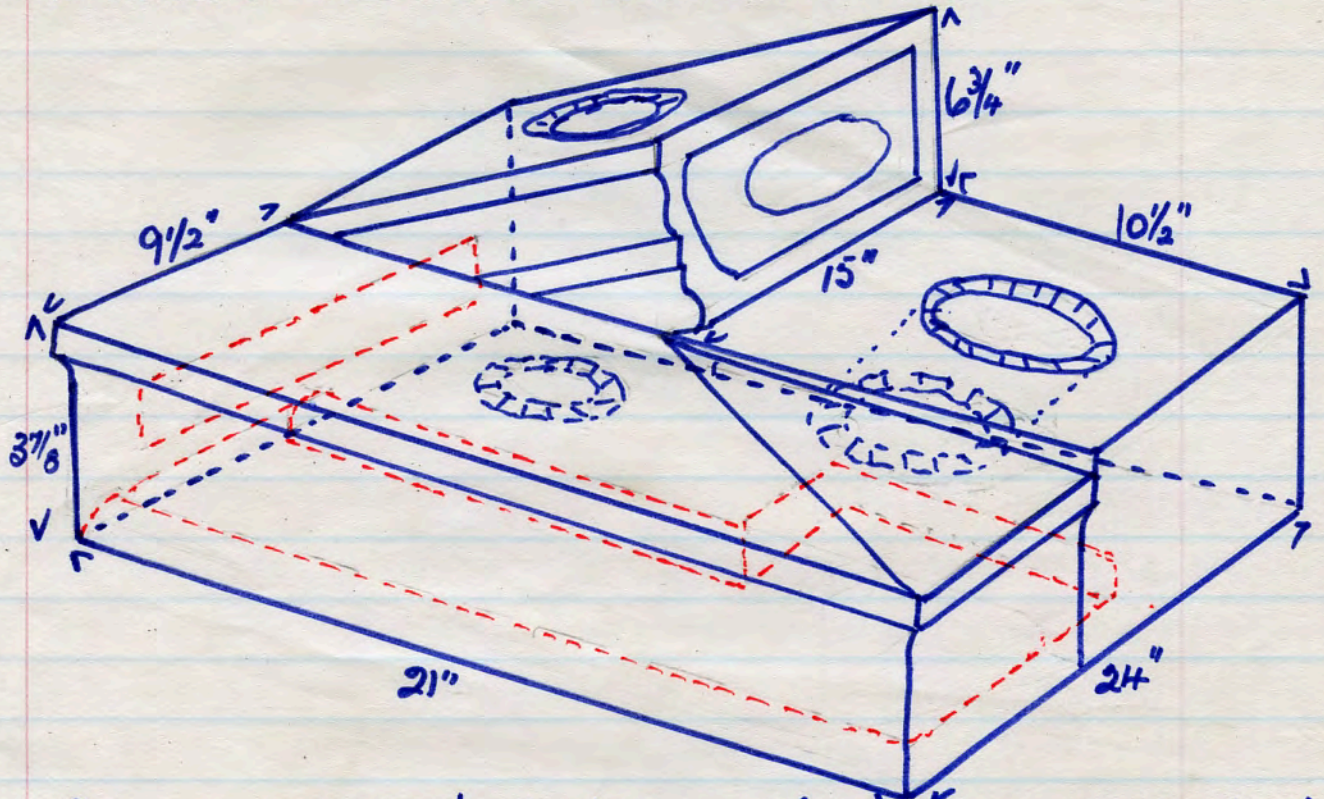

Commencement of dec. overhanging canopy of the offices of Stanhill Ring Mill, 10/12 twist. 23. 6. 85

3515

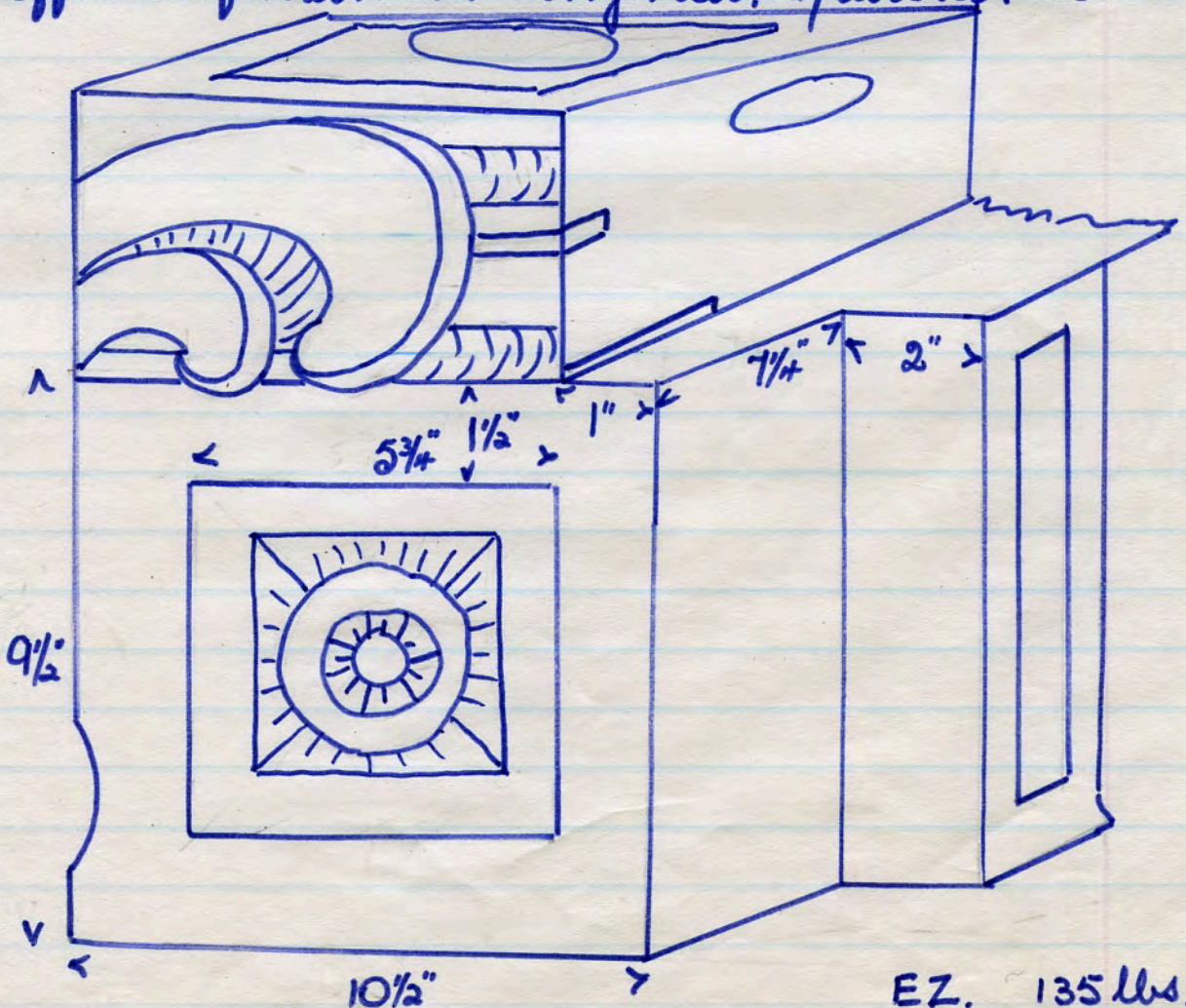

EZ. 135 lbs.

part of large red T.C dec. from Mill Lane, Leigh. 7. 7. 85

No name EZ 322 red T. C. finial. Mill Lane, Leigh.
 140 lbs 24. 9. 85

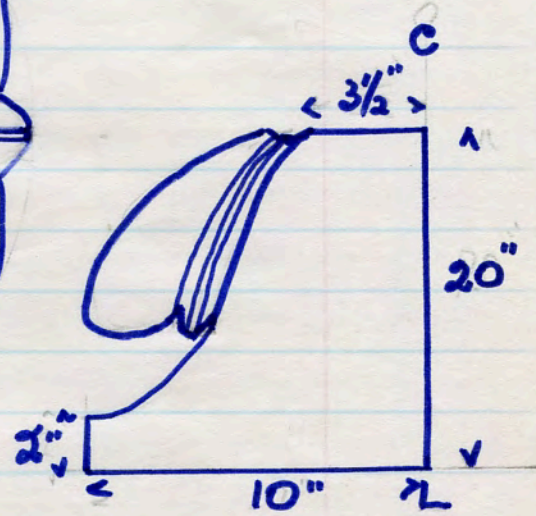
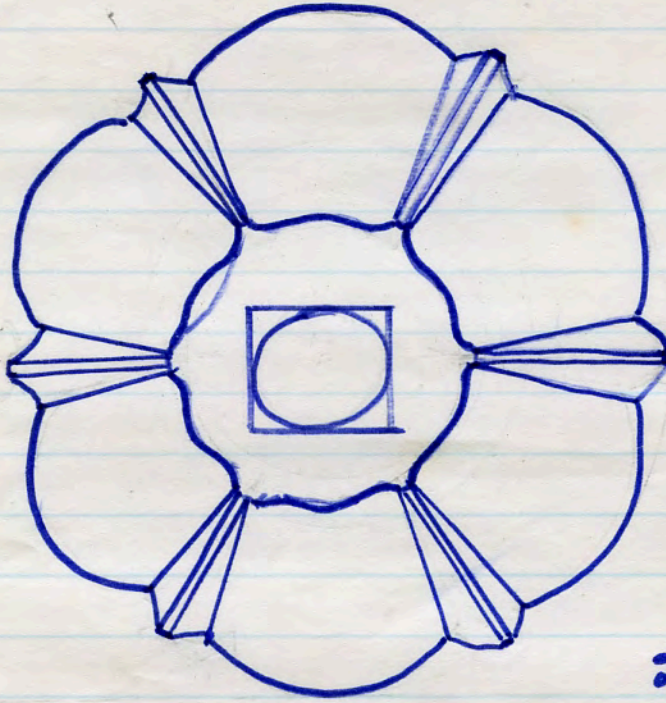

3517

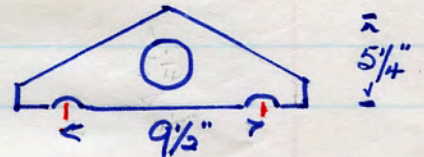
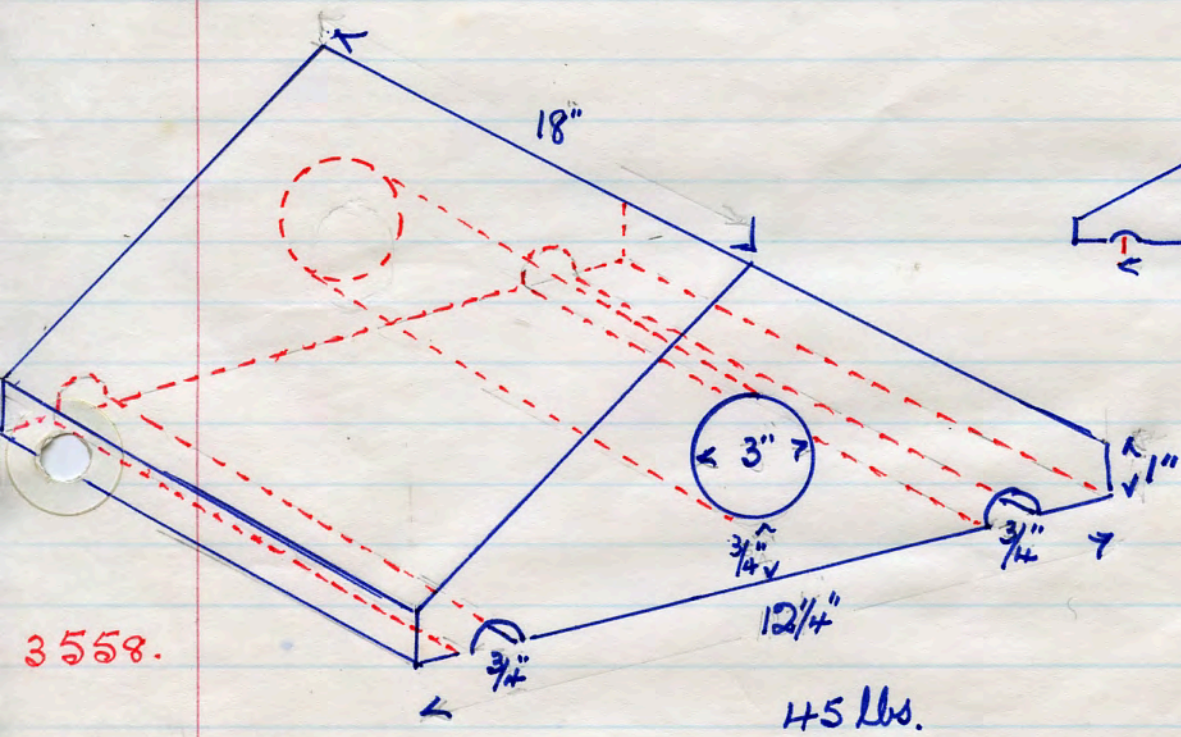

3558.

145 lbs.

No name. wall capping. salt glazed.
 Meadow St. Lower Audley. Blackburn. 7. 9. 86.

No name. red T.C
(Confield)

Accington, St John
Ambulance Hall
dem
9.8.85

3521

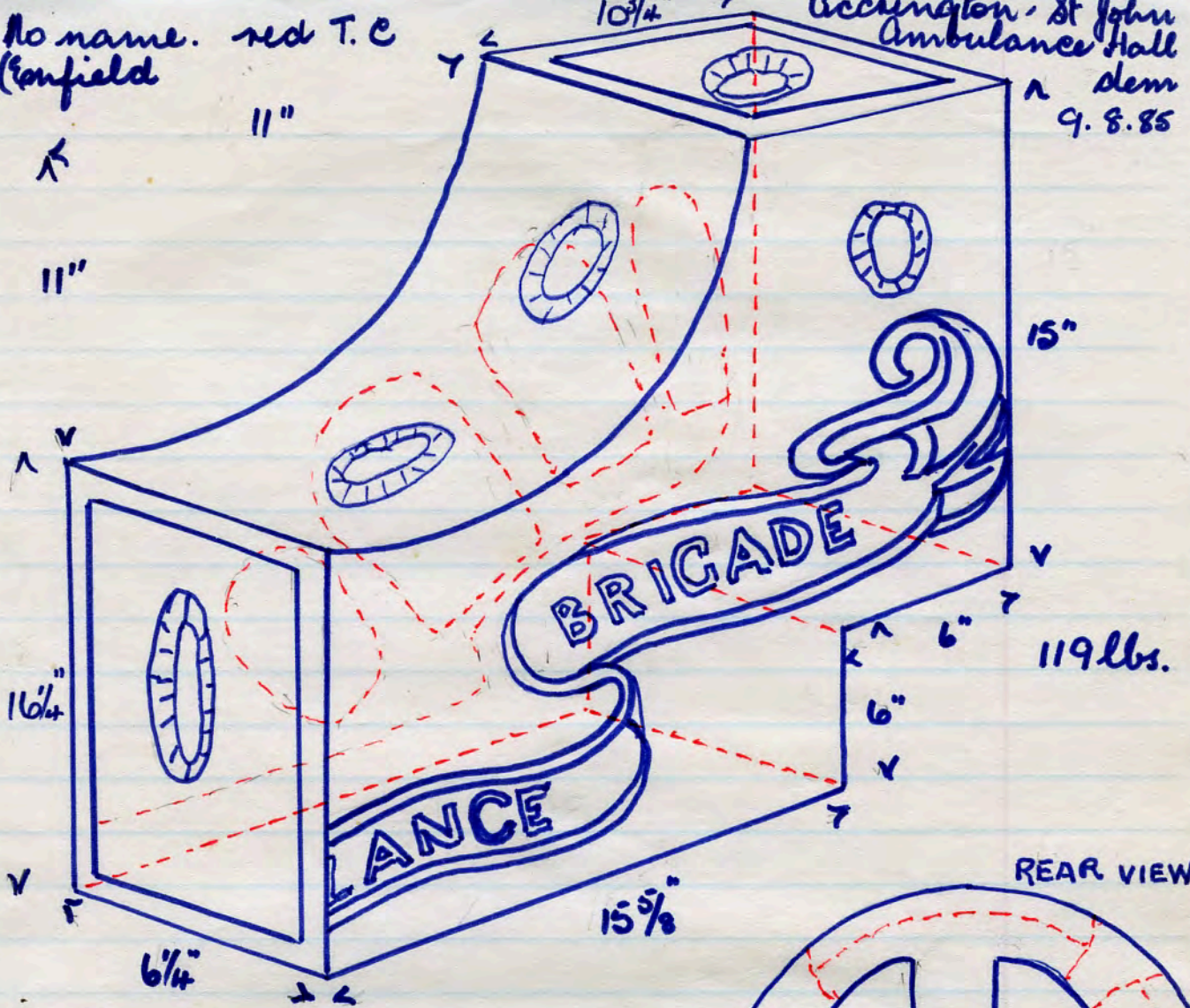

Ribbon scroll

Badge fits in
curve of
3521. 2 3/4"

REAR VIEW

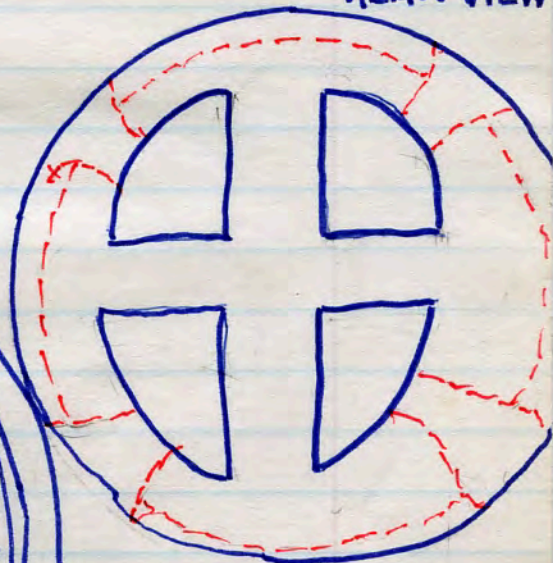

3522

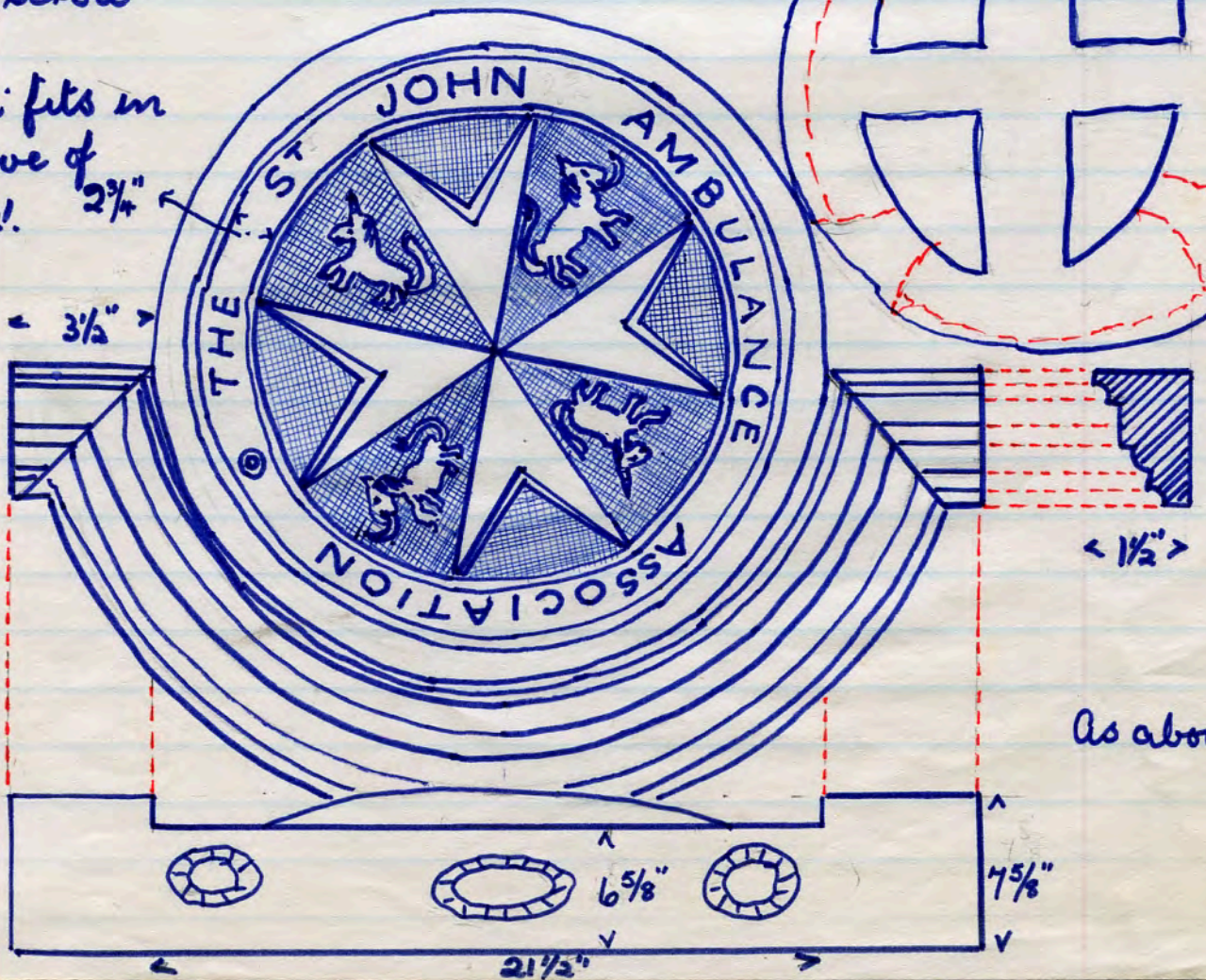

As above.

MONK & NEWELL RUABON

T : 9

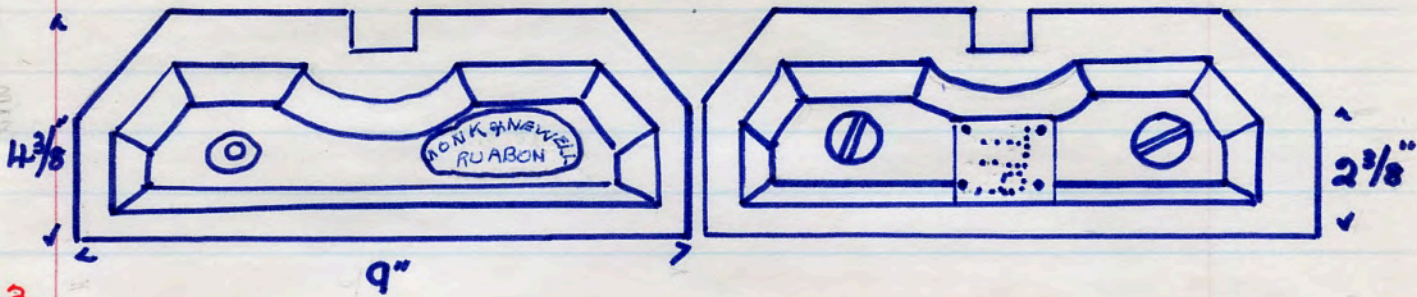

3523

red T.C. dec. brick.

7 1/4 lbs. 9" x 4 3/8" x 3 1/8" 1/2" x 1/2" bar groove
 letters stamped obv. T : 9 incised in dots. rev.
 single panel each side

DENNIS RUABON D510.

buff terra cotta. dado or string course.

3532

11 lbs. letters stamped 1 end.

Bay Tree Mill dem. Middleton Junction. Co. H. '86.

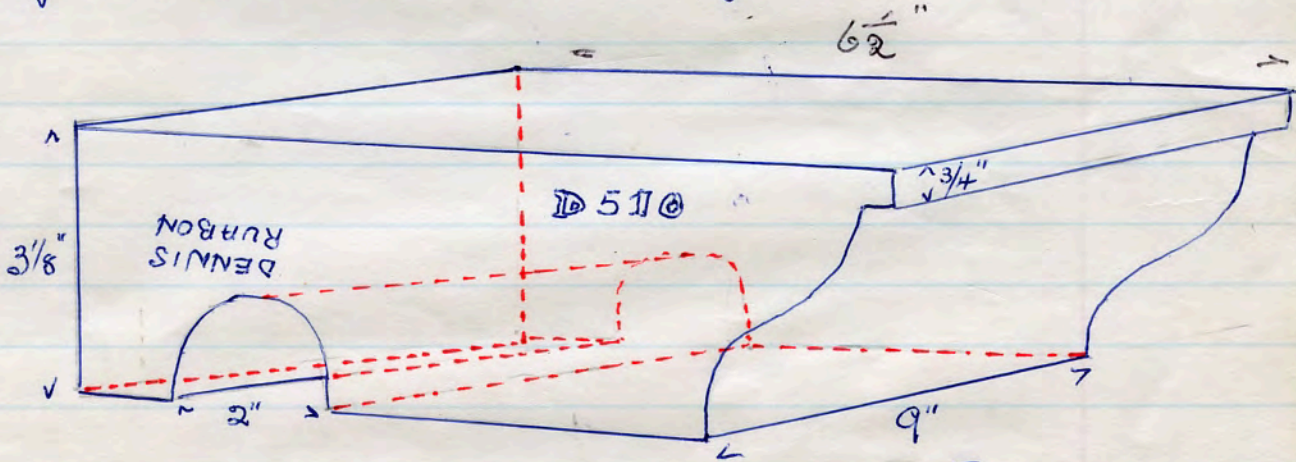

D517 fits with D510

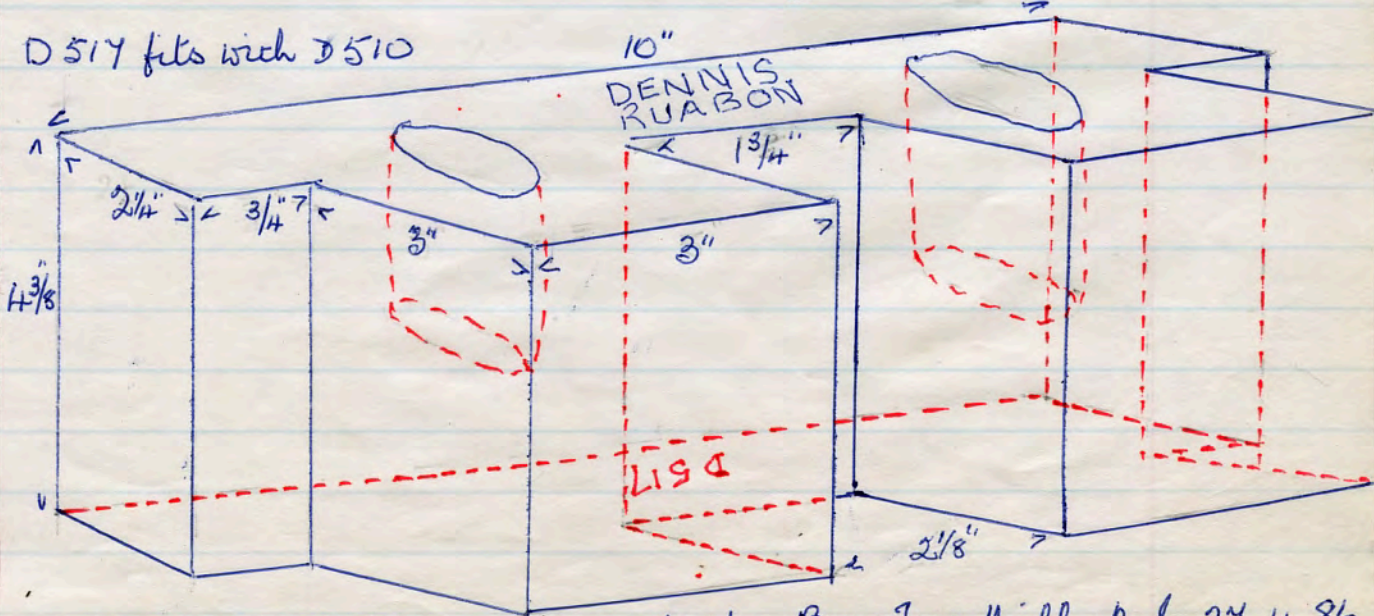

3534

14 lbs. buff T.C. to form dec. dado. Bay Tree Mill. Mf. 27. H. '86.

W.B. (W. Brook, Hathershaw)
 red dec. string course brick. egg & dart pattern
 6 1/2 lbs. 9" x 4 3/8" x 3"
 letters (double) incised in single panel (pennant) in ^{base.}
 cottage dem. Foxdenton Lane, Middleton Junction
 6. 4. '86.

3533

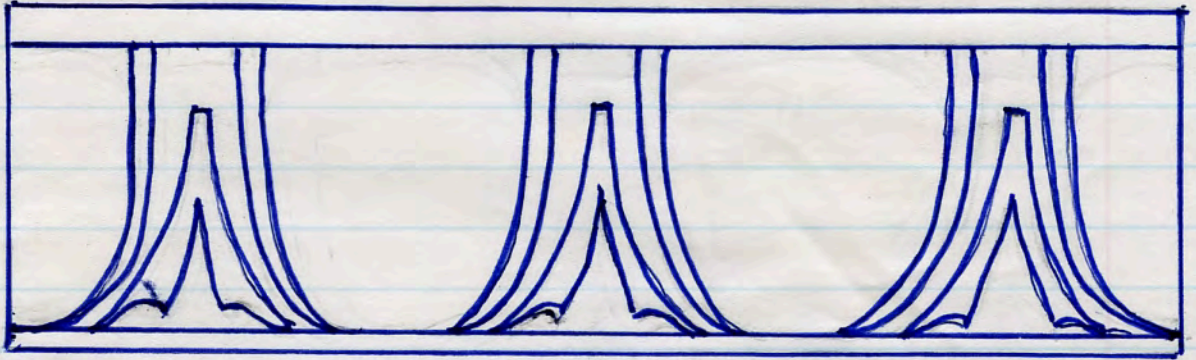

No name. Floor drain tile, red terra cotta.
 26 lbs. 12 1/2" x 12 1/2" x 3/4"
 16 square perfs. 1 1/2" x 1 1/2" x 3/8". 25 studs on reverse.
 C.P.A. Loveclough Print Works, Brawshawbooth. 27. 5. 86.

3541

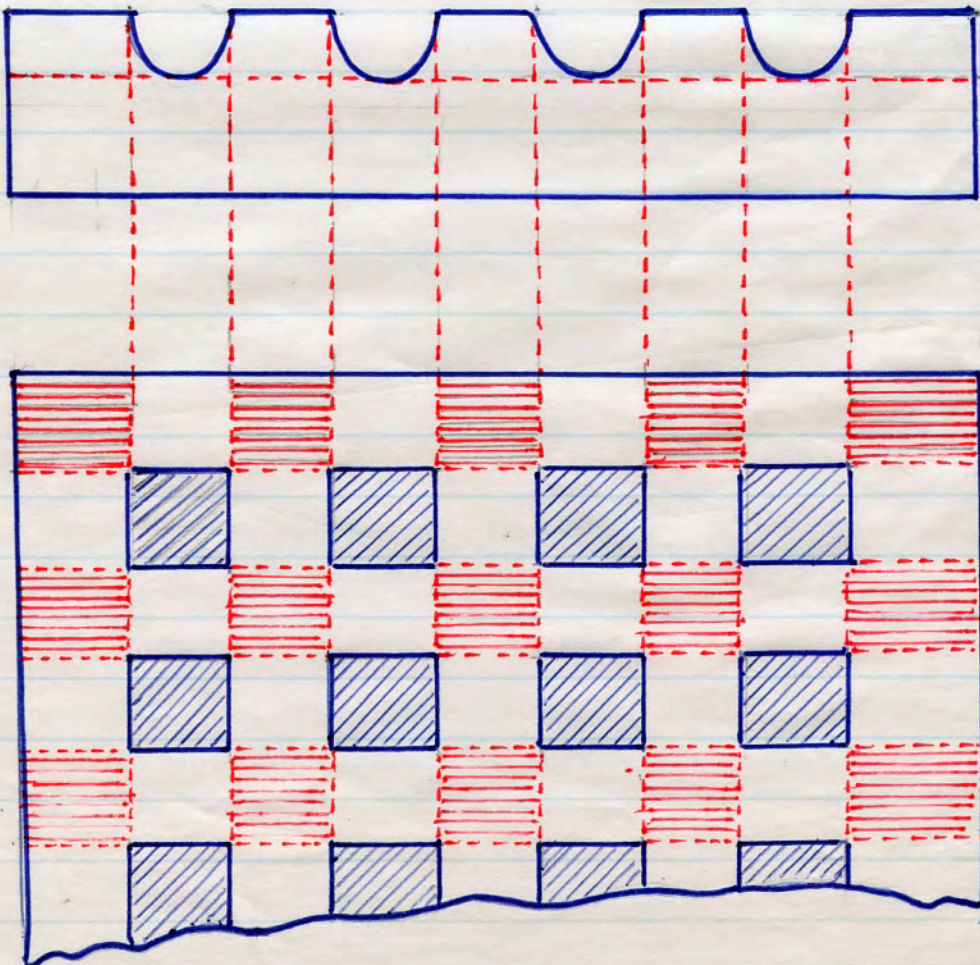

No name SO 57 stone coloured T.C. string course.
24 lbs.

3544

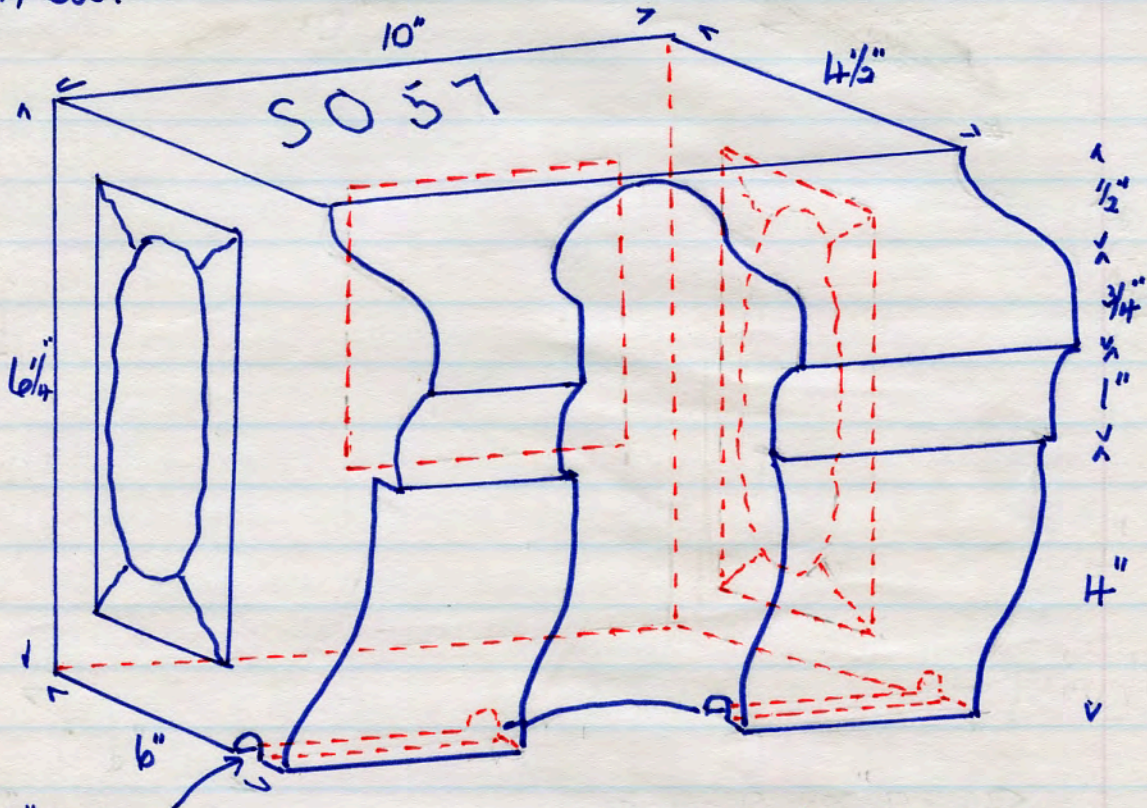

1/4" water groove

made to fit 3" R.W.P.

Office dem. Stanhill Ring Mill. 10/twistle. 22. 7. 86.

3545

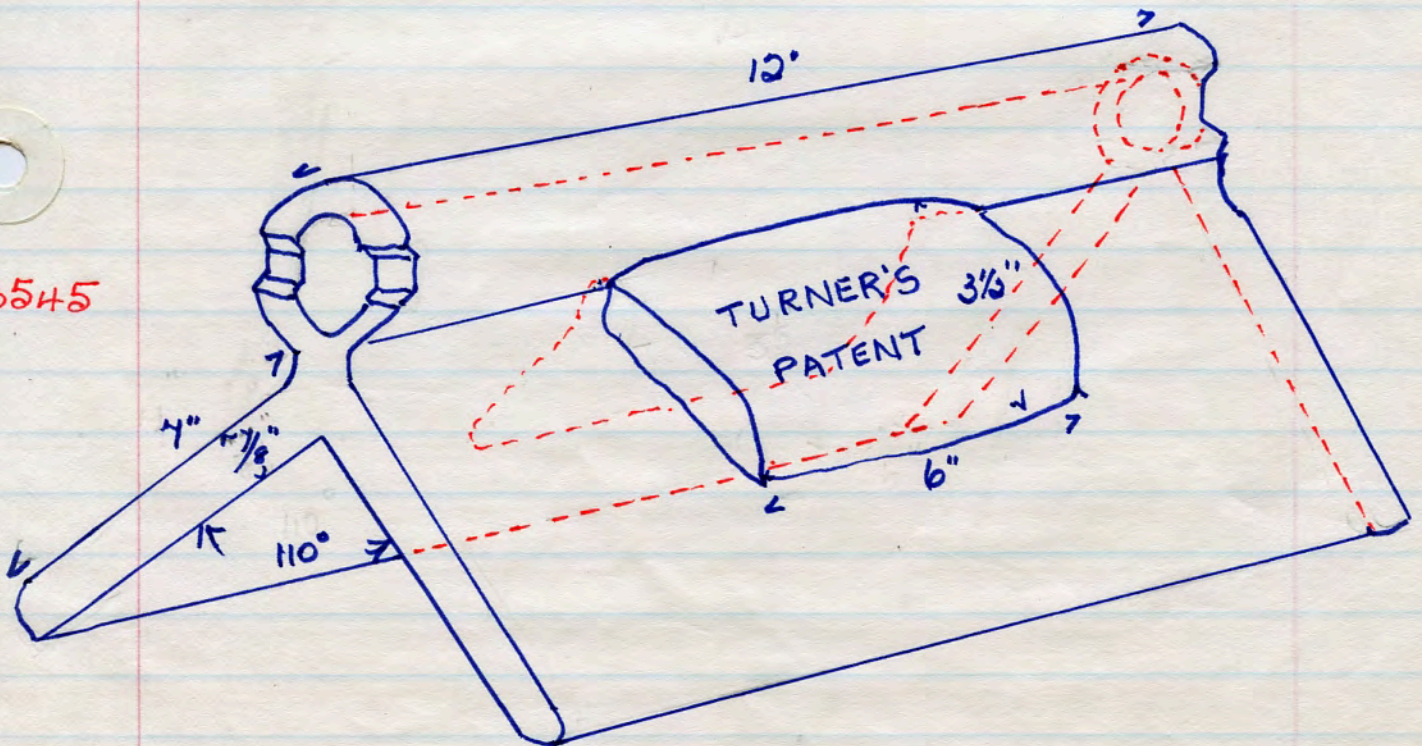

TURNER'S PATENT red clay ridge tile

10 lbs

Messrs. Hull. 19. 7. 86.

No name SO 239 stone coloured T.C. junction between
 54 lbs. pitch of roof and horizontal.
 Office dem. Stanhill Ring Mill. W/twistle. 22. 7. 86.

3546.

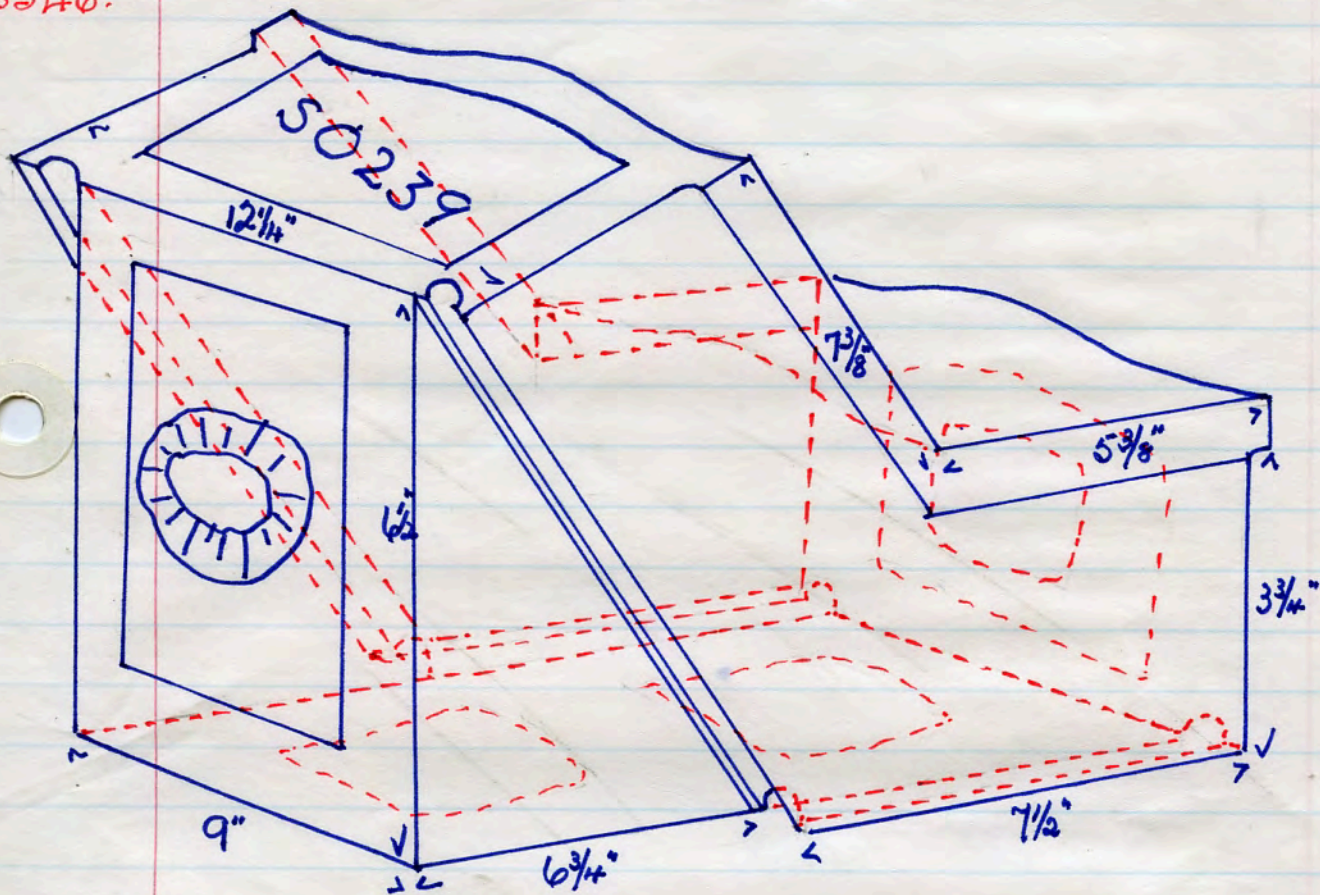

HAMBLET. blue channel brick.
 8 lbs. $8\frac{7}{8}'' \times 4\frac{1}{4}'' \times 3''$

3547.

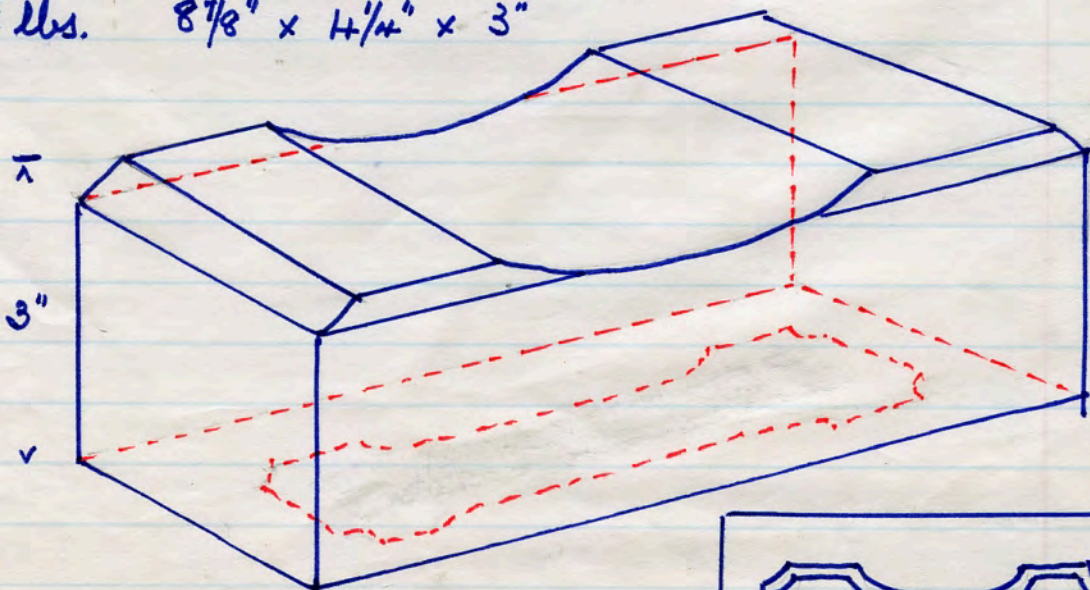

double letters incised in base.
 Mrs Hos. Hull. 19. 7. 86.



3553

No name. red. large corbel. common brick material.
 12 lbs. $12\frac{3}{4}" \times 4\frac{1}{4}" \times 3\frac{1}{8}"$
 single panel each side
 dem. site opp. L.U.F.C. ground
 Balland Rd. Leeds 9. 7. 86.

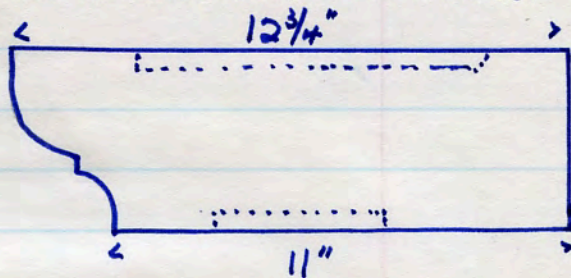

3554

No name. red T.C. sapping
 6 1/2 lbs. $6\frac{3}{8}" \times 6\frac{1}{8}" \times 3"$
 no panels.
 2 perfs. $\frac{3}{4}" + \frac{1}{2}"$ diam, in 1 end.
 Mrs. Hos. 19. 7. 86.

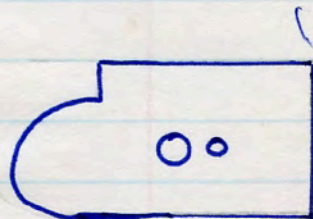

3555

No name. red T.C. wall cap.
 14 lbs. $9\frac{1}{4}" \times 9" \times 4"$
 no panels.
 3 perfs. $\frac{3}{4}"$ diam. 4 perfs $\frac{1}{2}"$ diam.
 water drip in each side
 Mrs. Ros 19. 7. 86.

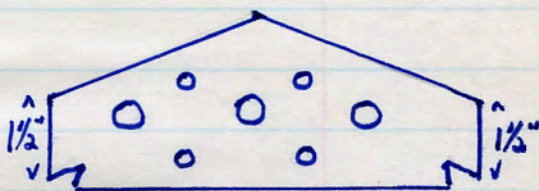

3556

No name. red T.C. window sill.
 14 lbs. $9\frac{1}{2}" \times 6" \times 4\frac{1}{2}"$
 no panels. water bar $\frac{5}{8}" \times \frac{3}{8}"$ on top
 3 perfs 1" diam. 1 perf $\frac{5}{8}"$ diam
 4 perfs $\frac{1}{2}"$ diam.
 water drip in base $\frac{1}{2}" \times \frac{1}{2}"$
 Mrs. Hos. 19. 7. 86.

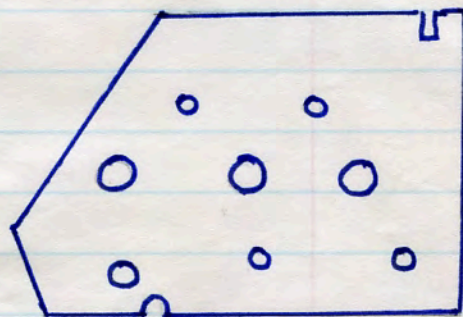

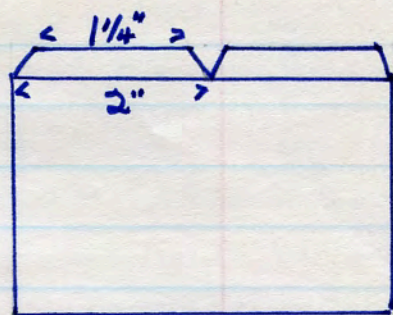
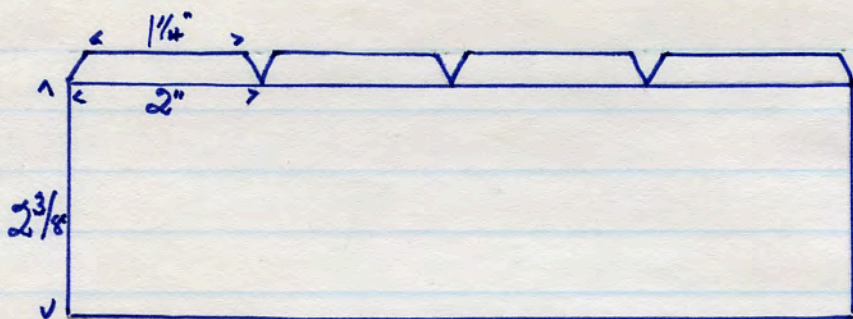

3557



W (P+S Wood, Pump House Bricks Works, West Bromwich)
blue paven.

8 lbs. $8\frac{3}{4}'' \times 4\frac{1}{4}'' \times 2\frac{7}{8}''$

8 chamfered studs $2'' \times 2''$ at base, $1\frac{1}{4}'' \times 1\frac{1}{4}''$ at top. obv.
single panel rev. with star trade mark in relief.

Mr K. Rawstron, Aysgath. 1. 8. 86.

No name

Blue sett stone (Whinstone)

13 lbs. $8'' \times 5'' \times 3\frac{1}{2}''$

3565

no panels. chamfered on face edges.

similar to nos 3056 & 3057.

Meadow St, Lower Audley, B/burn. 9. 9. 86.

100
3574

DENNIS RUABON 29 red T.C. special flat arch bricks.
8 lbs. $9" \times 4\frac{1}{4}" \times 2\frac{7}{8}" - 2\frac{1}{4}"$ (taper)
1 perf. $1\frac{3}{8}" \times 1\frac{3}{4}"$ ellipse.
no panels. back of brk eased off on each edge.
name stamped on 1 side.
numbers scraped on 1 end. JA stamped on same end.
Drill Hall dem. King St. Blackburn. 5. 10. '86

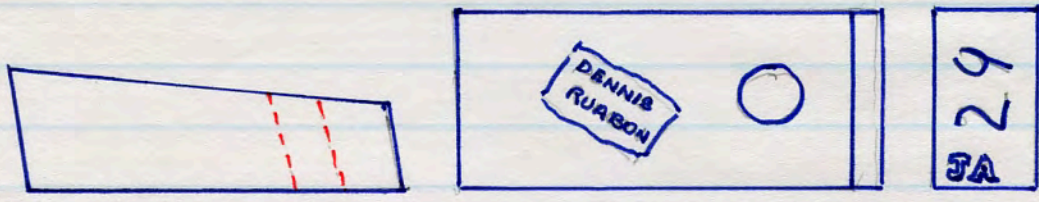

3592

BLACK HILL BRICK CO LTD ENTWISTLE NR BOLTON
red T.C. jamb brick
9 lbs. $9\frac{1}{8}" \times 4\frac{1}{2}" \times 3\frac{1}{8}"$
single panel each side.
letters small clear incised obv.
Bury Corporation Tram shed dem.
7. 6. '87.

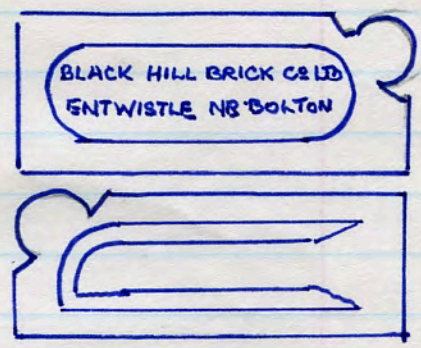

3594

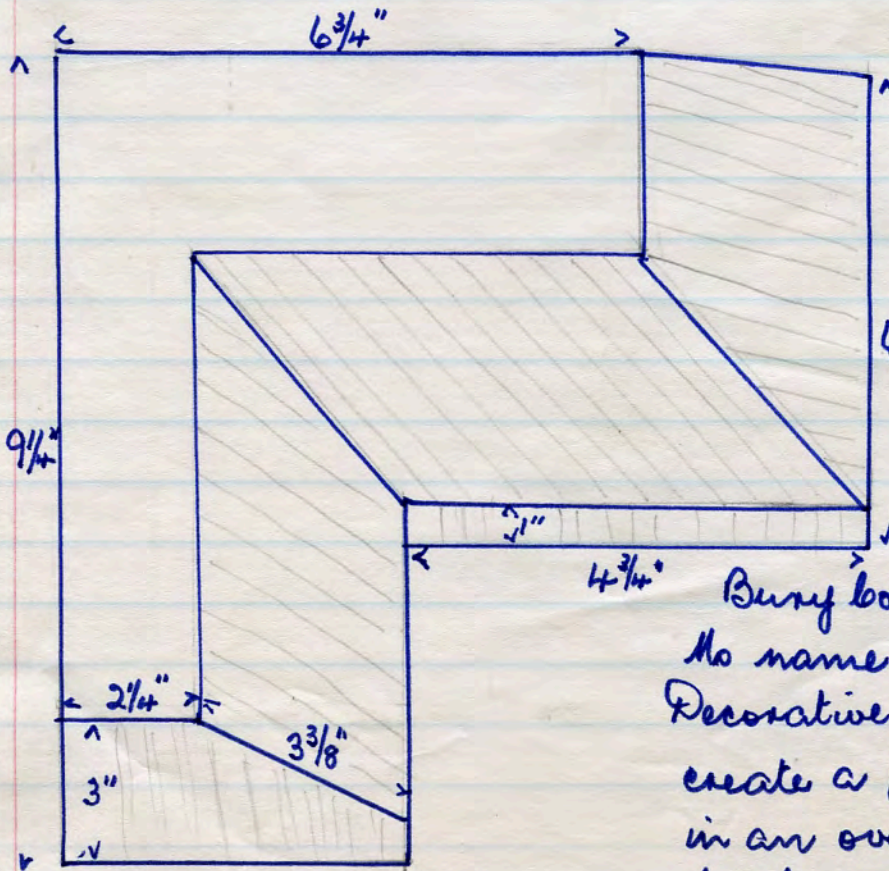

red T.C. 14 1/2 lbs
no panels
thumb scrapes in
base to act as
key.
 $6\frac{3}{4}"$
(Black Hill Co Ltd
Entwistle).
14. 6. '87

Bury Corp. Tram shed dem.
No name.
Decorative reduction base to
create a panel and a pillar.
in an over-all facade of
brickwork.

3595

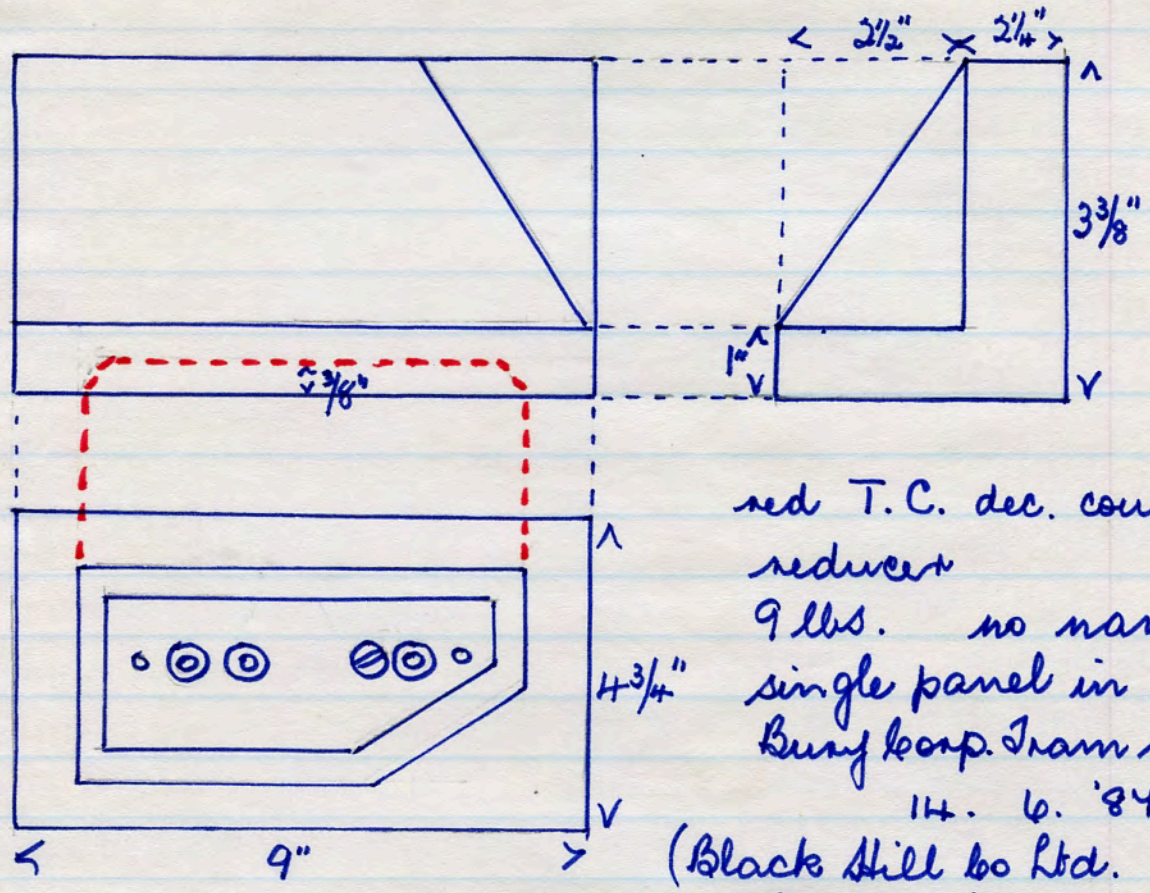

red T.C. dec. course
 redvert
 9 lbs. no name
 single panel in base
 Bung loop. Iron shed dem
 14. 6. '84.
 (Black Hill Co Ltd.
 Lontwistle)

3599

IRON blue paper.
 3 1/2 lbs 9" x 4 3/8" x 1 1/2"
 single panel in base
 plain face. letters in relief.
 Dr. f. book. Orlingbury, Kettering. 17. 6. '84

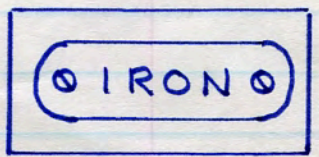

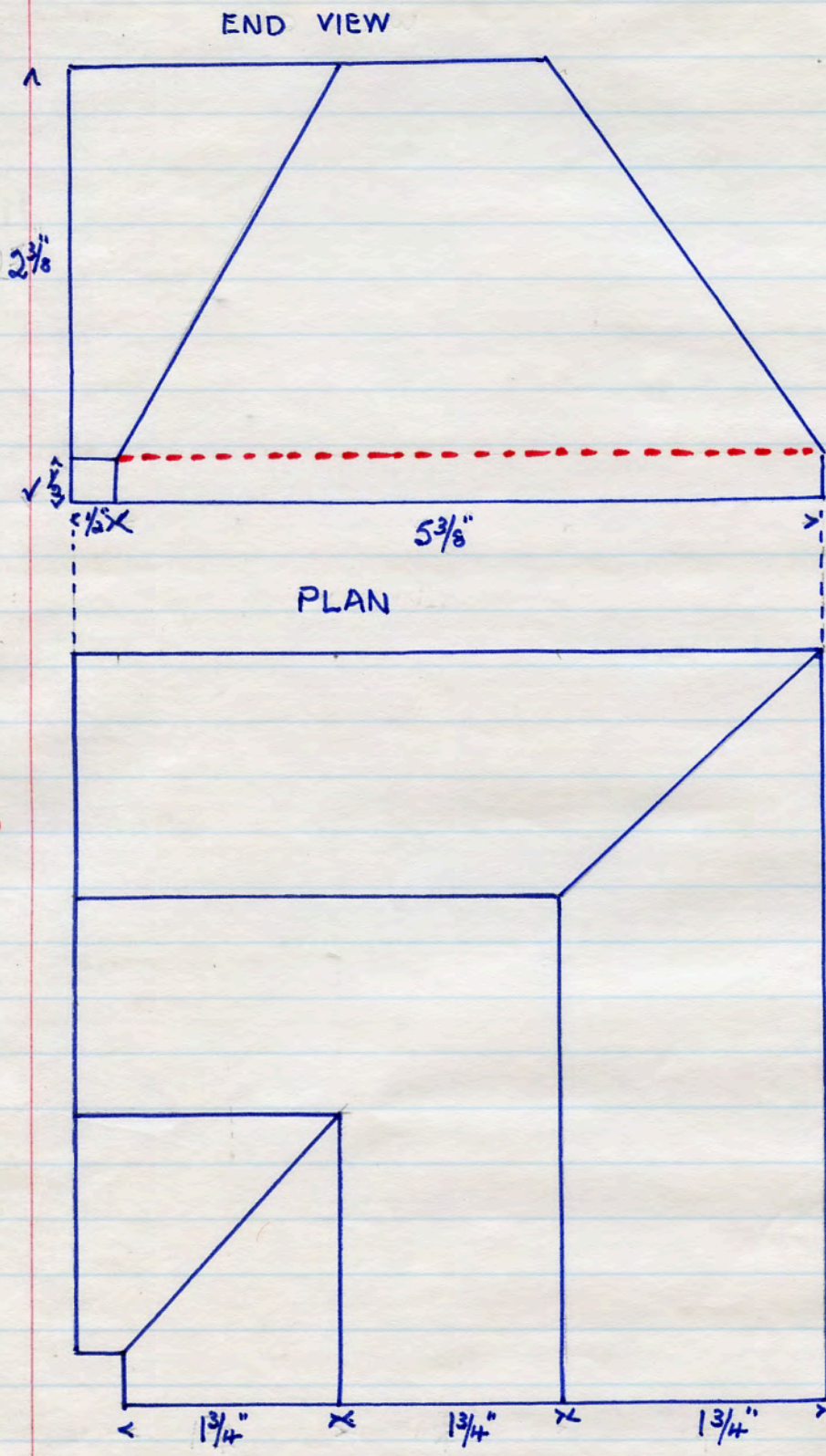

3622

No name. blue. return double chamfer
 5 lbs. $5\frac{3}{8}'' \times 5\frac{3}{8}'' \times 2\frac{3}{8}''$

no panels.
 Stansfield Rd. railway bridge dem. Waterfoot. 22. 9. '84
 (Stafford local & Iron Co. Ltd S-o-T.)

No name. red clay wall cap.
7 lbs. $9" \times 4\frac{3}{8}" \times 2\frac{3}{4}"$

3667. no panels.

En. f. book. lettering. 18. 6. '88

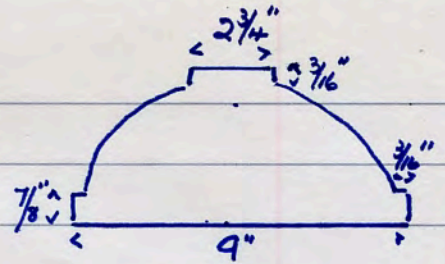

No name. malt kiln tile, clay.

14 lbs. $11\frac{7}{8}" \times 11\frac{7}{8}" \times 2"$

120 holes $\frac{3}{4}"$ diam which penetrate $1\frac{1}{8}"$.
remaining penetration consists of $8 \times \frac{1}{16}"$ holes

3687

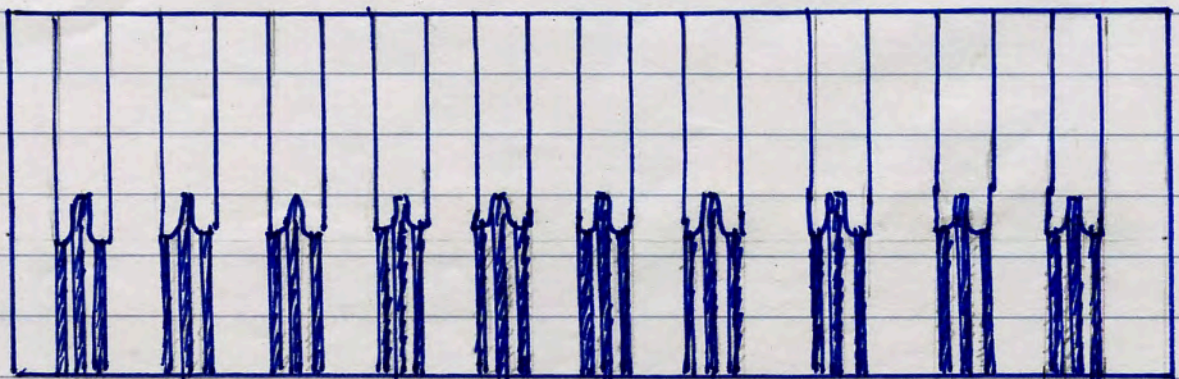
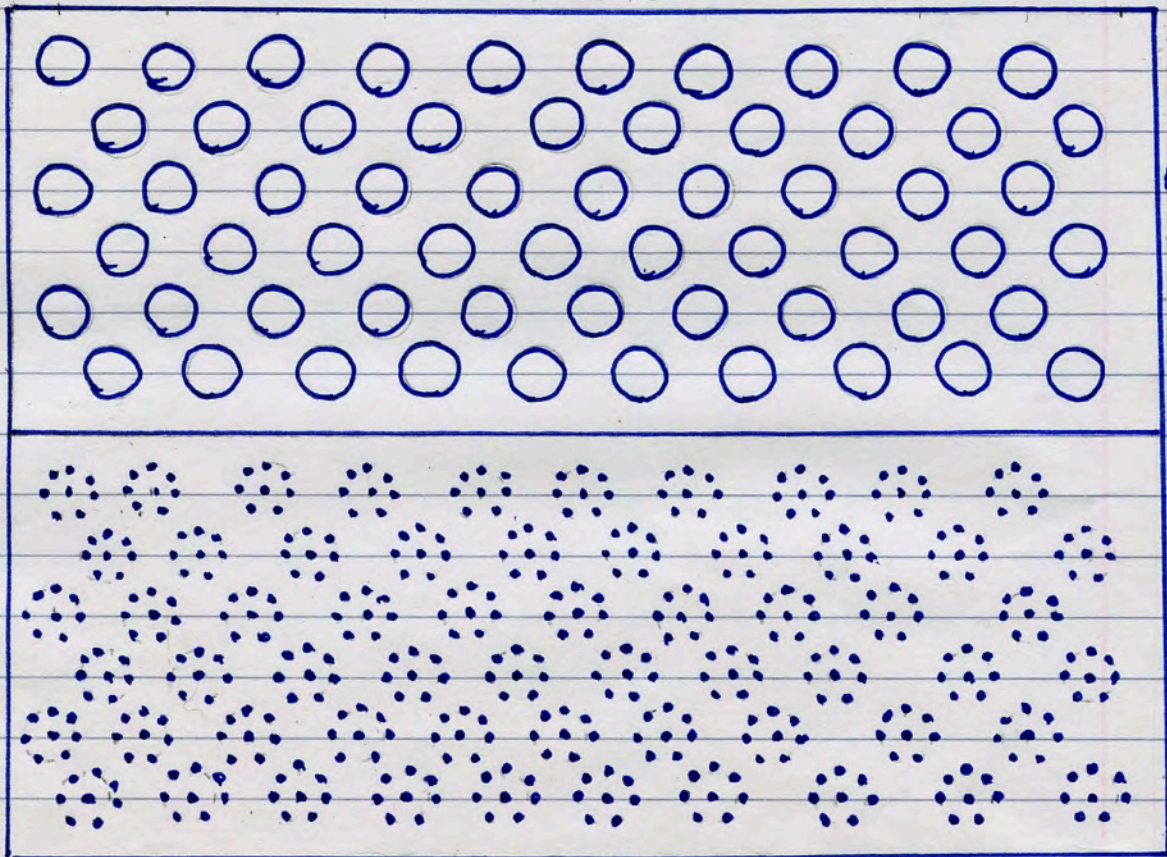

SECTION THROUGH TILE.